

一、材质和镀层:

- 1、胶芯: LCP, UL 94 V - 0, 黑色
- 2、端子: 磷铜C5210-H, T=0.15, 全区镀底30u"MIN, 触点镀金GOLD FLASH0.6-1.0u", 焊脚双面镀亮锡50-80u".
- 3、定位脚: 磷铜C2680-H, T=0.20, 全区镀底30u"MIN, 镀亮锡50-80u".
- 4、外壳: 不锈钢 T=0.2

二、技术参数:

- 接触电阻: 100mΩ Max
- 绝缘阻抗: 1000MΩ Min(500DC)
- 额定电流: 每个接触件1A Max
- 额定电压: 30V Max(DC)
- 耐压: 500V r.m.s/min
- 使用温度: -40℃ ~ 85℃
- 湿度: 80% R.H MAX
- 寿命: >3000次

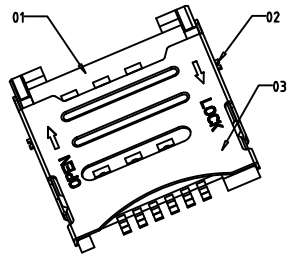
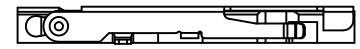
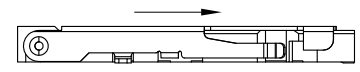
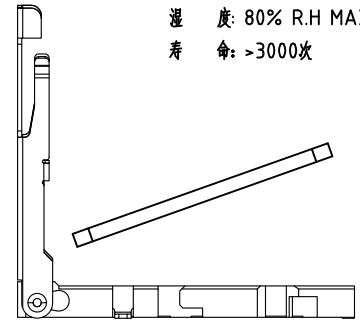
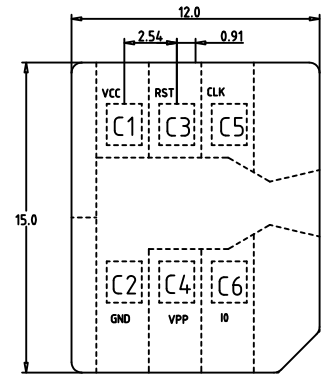
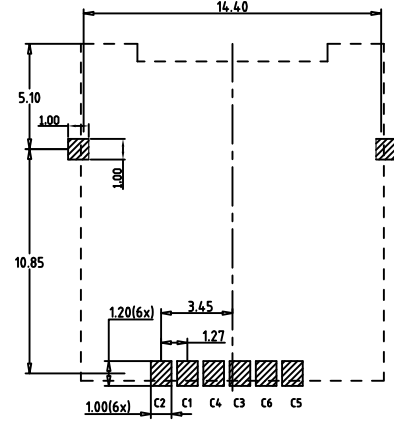
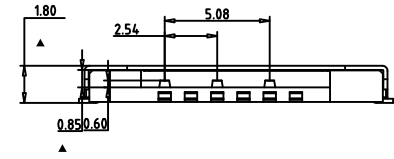
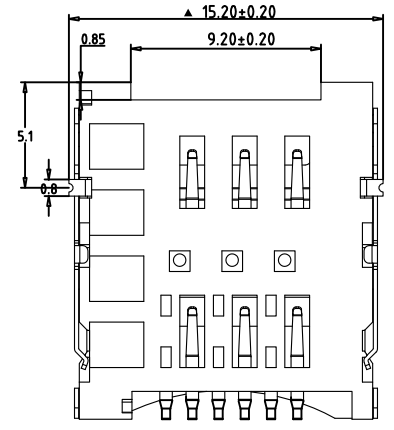
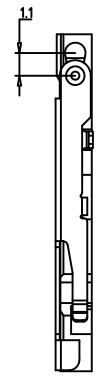
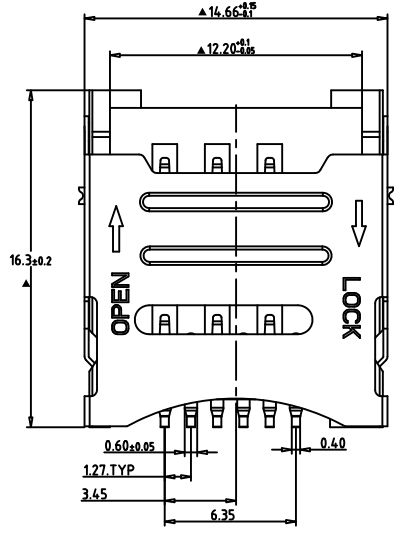

PIN NO.	NAME	PIN NO.	NAME
C1	VCC	C4	VPP
C2	GND	C5	CLK
C3	RST	C6	IO

**LXW** 连兴旺电子(深圳)有限公司  
LXWCONN ELECTRONICS (SHENZHEN) CO., LTD

工程变更通知单号 ECN(DCN) NO.	版次 REV	日期 DATE	说明 DESCRIPTION	改变 CHANGE	承认 APPRO.	GENERAL TOLERANCE UNLESS OTHERWISE NOTED
			修改PIN角宽度	赵文博		
			修改弹点高度	赵文博		
			修改实物与图纸相符	赵文博		

设计 DESIGN	Nicolas		
校阅 CHECK	Nicolas		
承认 APPRO.			

<b>C</b>	PRODUCT SPEC.
TITLE:	* 数据表
PART NO.	CS-0005-06180
FILE NAME.	
SCALE	UNIT:mm A4 SHEET: of

# RoHS

- NOTES**
1. RE DETAILED DIMENSION. SEE PRODUCT DRAWING.
  2. NUMBER OF CONNECTORS : 1200 PCS/REEL
  3. LEAD TAPE LENGTH

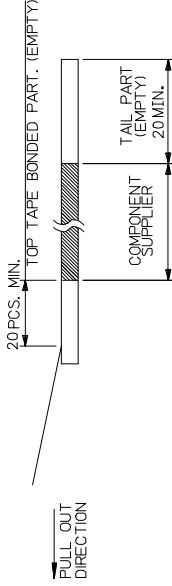

4. PEELING OFF FORCE OF TOP TAPE : 0.1N~1.3N(10gf~130gf)  
(PEELING DIRECTION AS SHOWN IN FOLLOWING FIG.)  
THIS REQUIREMENT SHOULD BE APPLIED AT SHIPMENT.  
PEEL OFF SHOULD NOT BE ALLOWED , DURING TRANSPORTION.

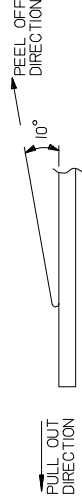

5. MATERIAL  
(CARRIER TAPE) : (POLYSTYRENE)  
(TOP TAPE): PET  
(REEL) : (PS)
6. RoHS COMPLIANT

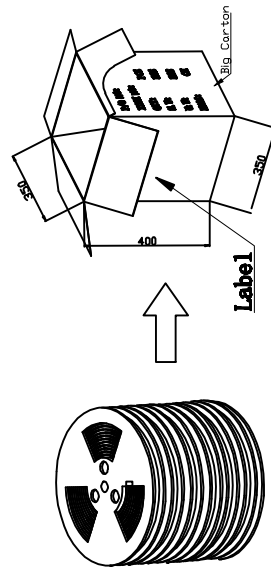
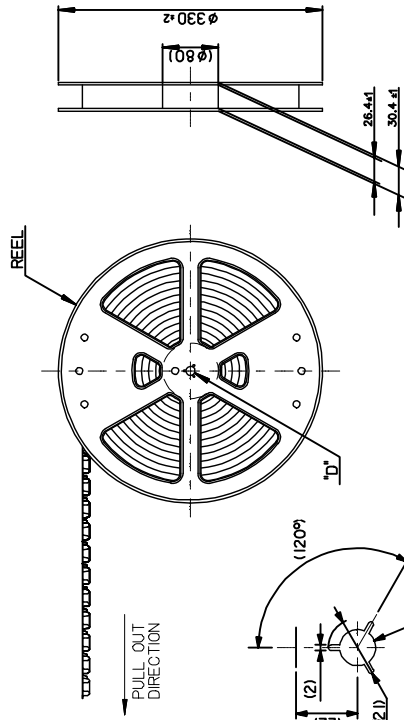
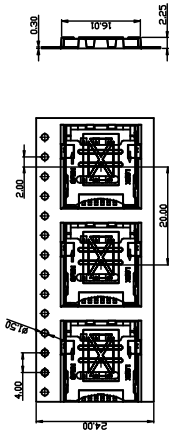

1200pcsX11=13200pcs

**LXW** 连兴旺电子(深圳)有限公司  
LAWOON ELECTRONICS (SHENZHEN) CO., LTD

**C** PRODUCT SPEC: Mini SIM

TITLE: Mini SIM \* H1.8 封装式

PART NO. CS-0005-06180

FILE NAME:

SCALE 1:1 UNIT:mm A4 SHEET:1 of 1

General	Angle	设计	Nicolas	12'/08/20
X±0.50		DESIGN		
.X±0.30	X'±3'	校核	Nicolas	12'/08/20
.XX±0.20	.XX'±2'	CHECK		
GENERAL TOLERANCE UNLESS OTHERWISE NOTED		承认		
CHANGE APPRO.		承认		
A	12'/08/20	NEW RELEASE		
工程变更通知单 ECN(DCN) NO. REV	日期 DATE	说明 DESCRIPTION		