

Features:

1. 2~24 circuits available;
2. Material: Pa66+15%GF UL94V-0, Black color;
3. Contact: Brass;
4. Finished: Tin-plated;
5. 0.64mm square pin;
6. Mates with H300012-XX housing;

Specification:

Current rating: 5A AC/DC
 Voltage rating: 250V AC(RMS) or 250V DC Max
 Contact resistance: 10mΩ Max
 Insulation resistance: 1000MΩ Min
 Dielectric withstanding voltage: 1500V AC/minute
 Ambient temperature rang: -20°C~+85°C

Dimensional Information(mm)

Circuits	DIM A	DIM B	Circuits	DIM A	DIM B
02	/	6.65	14	18.00	24.65
04	3.00	9.65	16	21.00	27.65
06	6.00	12.65	18	24.00	30.65
08	9.00	15.65	20	27.00	33.65
10	12.00	18.65	22	30.00	36.65
12	15.00	21.65	24	33.00	39.65

H300014-XX
 SERIES NO:
 PIN Q' PY:
 02~24

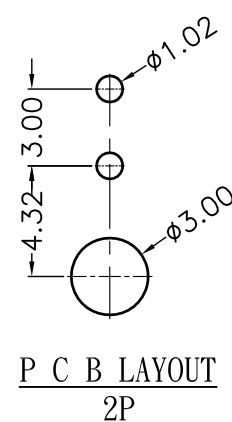
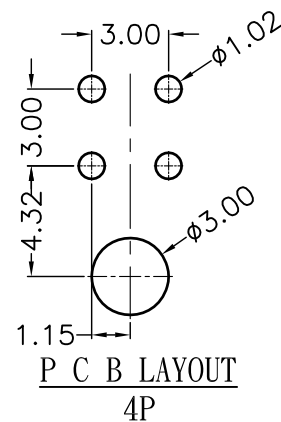
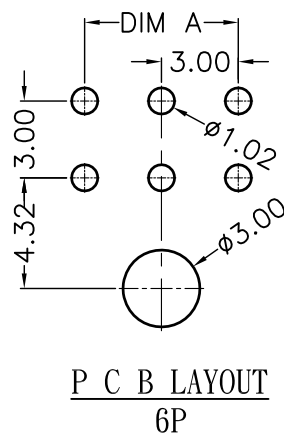
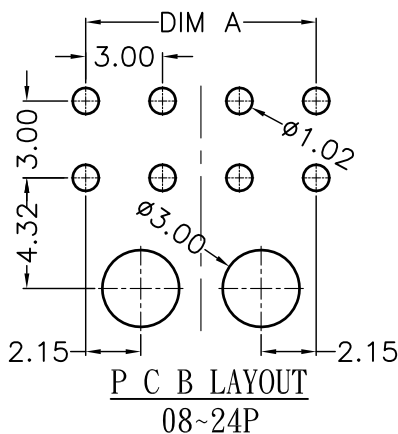
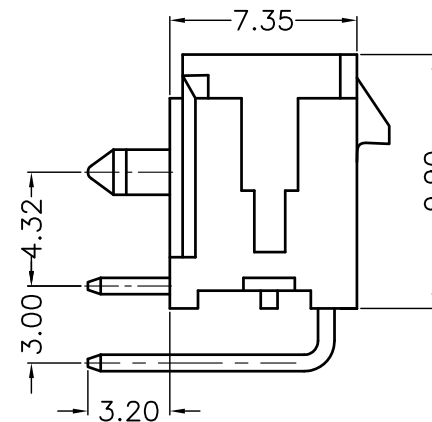
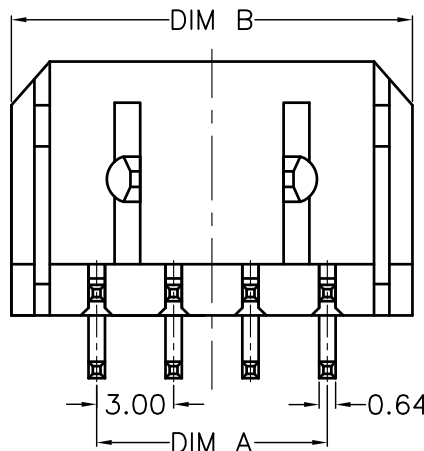
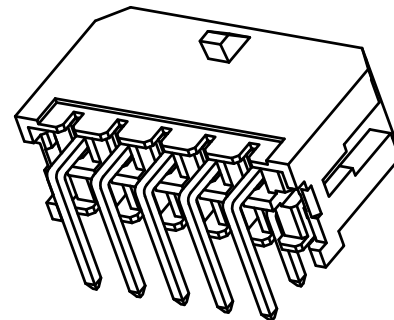
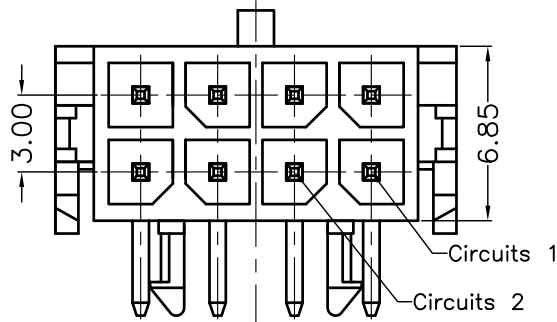

REV	Description	DATE	GENERAL TOLERANCES (unless specified)	UNITS	MM	DATE	2014-03-05
			X.X±0.4	SCALE	1:1	DRAWING	Liu zhi guo
			X.XX±0.25	REV	A	CHECKED BY	Li peng
			X.XXX±0.15	APPROVAL BY	OYSW		

LXW 连兴旺电子(深圳)有限公司
 LXWCONN ELECTRONICS (SHENZHEN) CO., LTD
 PRODUCT NAME: 3.0 mm right angle header
 PART NUMBER: H300014-XX

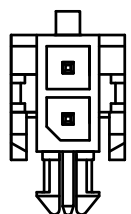

2 CKTS

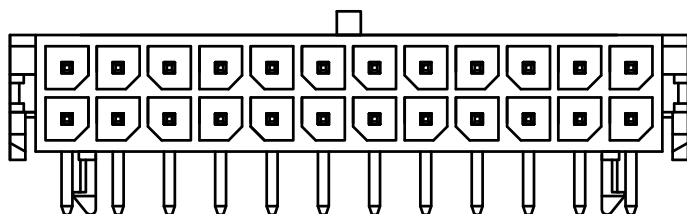

24 CKTS

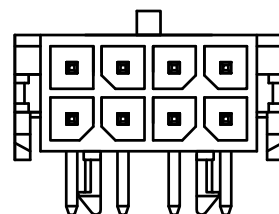

08 CKTS

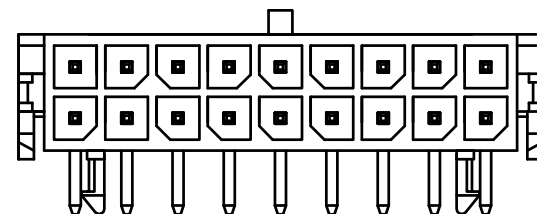

18 CKTS

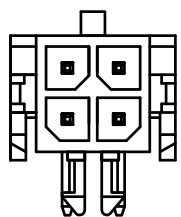

4 CKTS

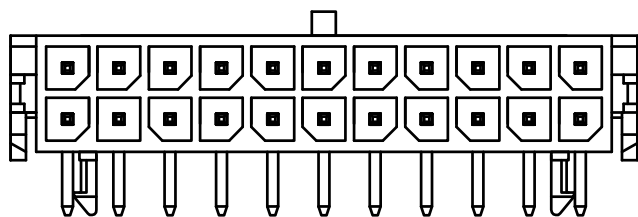

22 CKTS

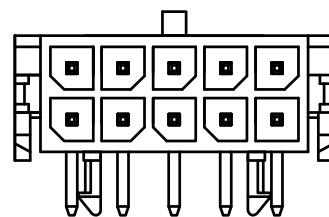

10 CKTS

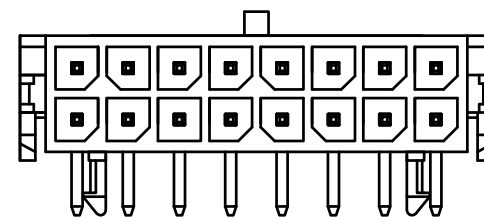

16 CKTS

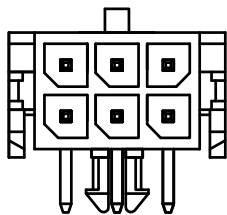

6 CKTS

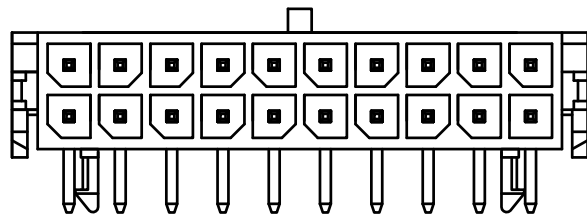

20 CKTS

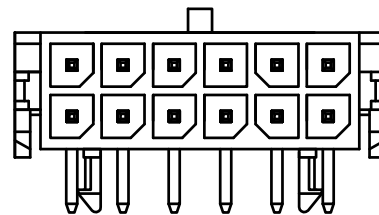

12 CKTS

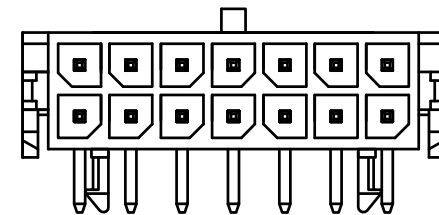

14 CKTS

REV	Description	DATE	GENERAL TOLERANCES (unless specified)	UNITS	MM	DATE	2014-03-05
			X.X±0.4	SCALE	1:1	DRAWING	Liu zhi guo
			X.XX±0.25	REV	A	CHECKED BY	Li peng
			X.XXX±0.15			APPROVAL BY	OYSW



连兴旺电子(深圳)有限公司

LXWCONN ELECTRONICS (SHENZHEN) CO., LTD

PRODUCT NAME 3.0 mm right angle header

PART NUMBER H300014-XX