

Features:

1. 2~24 circuits available;
2. Material: PA66+15%GF, Black color;
3. Contact: Brass;
4. Finished: Tin-plated;
5. 0.64mm square pin;
6. Mates with H300012-XX housing;

Specification:

- Current rating: 5A AC/DC
- Voltage rating: 250V AC(RMS) or 250V DC Max
- Contact resistance: 10mΩ Max
- Insulation resistance: 1000MΩ Min
- Dielectric withstanding voltage: 1500V AC/minute
- Ambient temperature rang: -20°C~+85°C

Dimensional Information (mm)

Circuits	DIM A	DIM B	DIM C
02	3.00	6.65	6.00
04	3.00	9.65	9.00
06	6.00	12.65	12.00
08	9.00	15.65	15.00
10	12.00	18.65	18.00
12	15.00	21.65	21.00
14	18.00	24.65	24.00
16	21.00	27.65	27.00
18	24.00	30.65	30.00
20	27.00	33.65	33.00
22	30.00	36.65	36.00
24	33.00	39.65	39.00

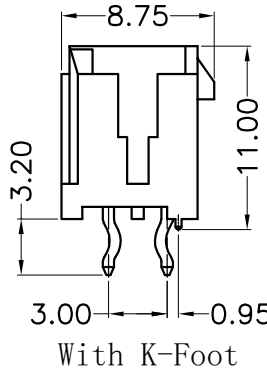
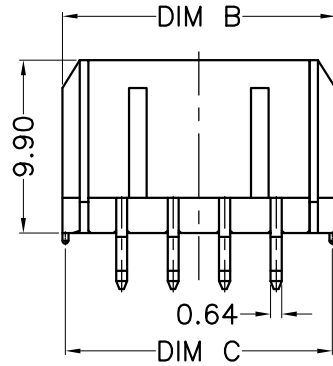
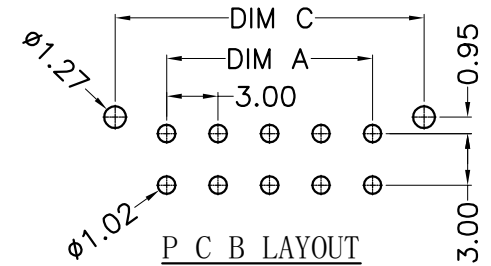
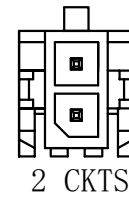
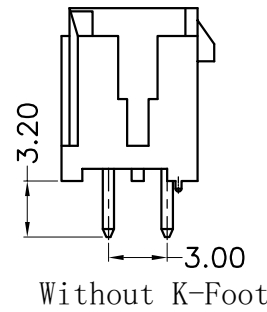
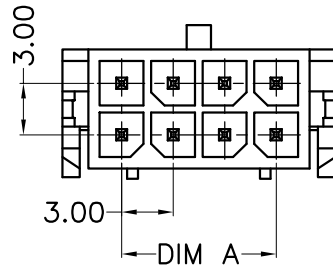

H300013-XX-XX

SERIES NO:

PIN Q'PY:  
02~24

K-Foot:  
00: Without  
OK: With

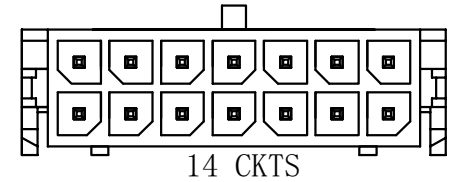
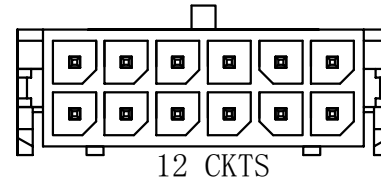
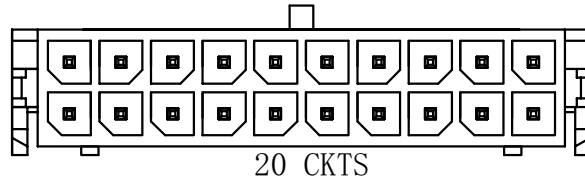
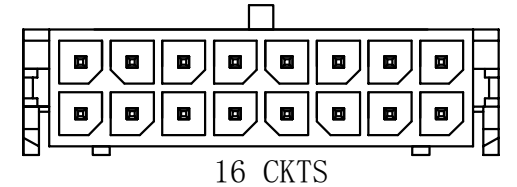
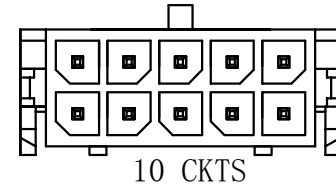
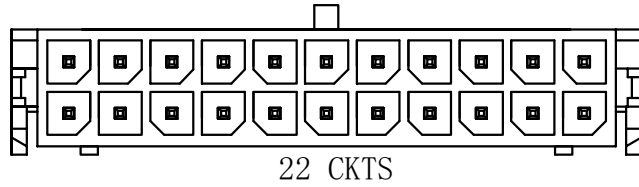
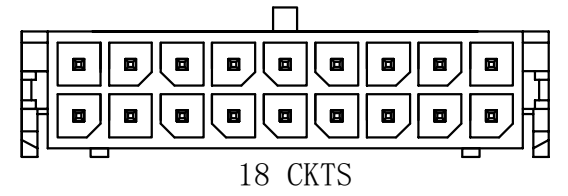
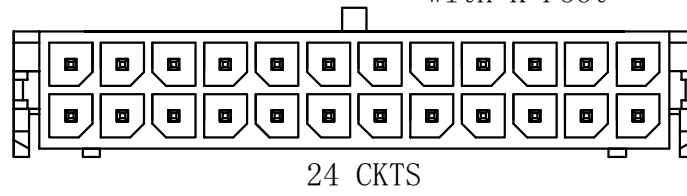
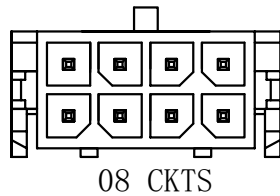
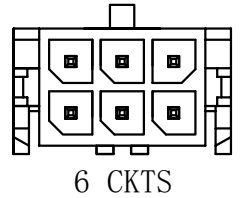
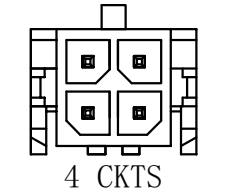

REV	Description	DATE	GENERAL TOLERANCES (unless specified)	UNITS	MM	DATE	2014-03-05
			X.X±0.4	SCALE	1:1	DRAWING	Liu zhi guo
			X.XX±0.25	REV	A	CHECKED BY	Li peng
			X.XXX±0.15	APPROVAL BY		OYSW	

**LXW** 连兴旺电子(深圳)有限公司  
LXWCONN ELECTRONICS (SHENZHEN) CO., LTD

PRODUCT NAME: 3.0 mm vertical header  
PART NUMBER: H300013-XX-XX