

2	3	4	5	6	7	8	9
标记 MARK	ECN编号/变更内容 ECN NO/DEFINITION	修改 REVISE	日期 DATE	核准 APPROVE			

	Pin	DIM A	DIM B
2	3.96	7.92	
3	7.92	11.88	
4	11.88	15.84	
5	15.84	19.80	
6	19.80	23.76	
7	23.76	27.72	
8	27.72	31.68	
9	31.68	35.64	
10	35.64	39.60	
11	39.60	43.56	
12	43.56	47.52	

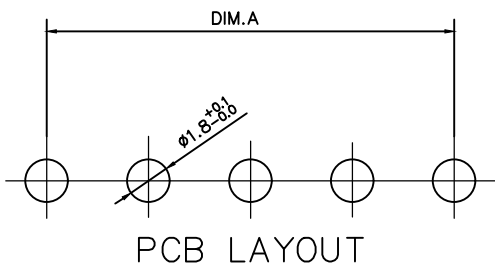
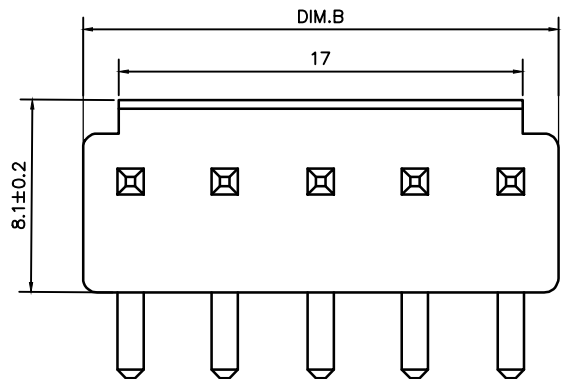
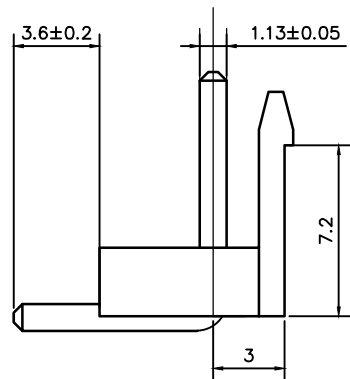
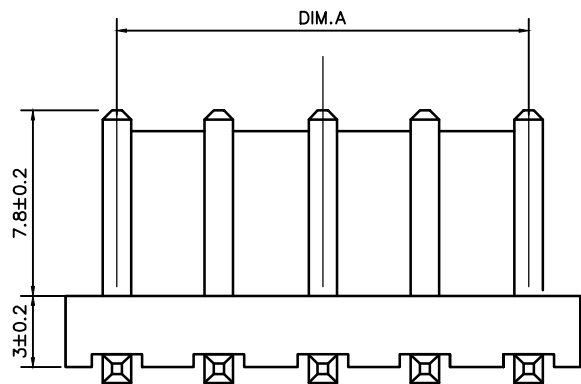

技术要求:

- 适应基板厚度: 1.2mm~1.6mm
- 温度范围: -25℃~85℃
- 额定电压: 250V AC/DC
- 额定电流: 7A
- 接触电阻: ≤0.01 Ω
- 绝缘电阻: ≥1000M Ω
- 耐压: 1500V AC/minute

2	插针	铜	镀锡	
1	底座	PA66	米色	
序号	品名	材质	电镀/颜色	备注

	深圳市虹成电子有限公司		品名 TITLE	针座
			料号 PART NO	HC-VH3.96-3AW-M
GENERAL TOLERANCES (UNLESS SPECIFIED)		比列 SCALE	1:1	
X.X ±0.35	X' ±3.00'	单位 UNIT	MM	
X.XX ±0.25	X.X' ±2.00'	张数 PART NO	1 OF 1	制图 DRAW
X.XXX ±0.15	X.XX' ±1.00'	版本 REV	A	审核 CHECKED
			批准 APPROVE	夏操云
				赵亮亮

