

标记 MARK	ECN编号/变更内容 ECN NO/DEFINITION	修改 REVISE	日期 DATE	核准 APPROVE

孔位	A	B
1	0.00	5.40
2	4.20	9.60
3	8.40	13.80
4	12.60	18.00
5	16.80	22.20
6	21.00	26.40
7	25.20	30.60
8	29.40	34.80
9	33.60	39.00
10	37.80	43.20
11	42.00	47.40
12	46.20	51.60

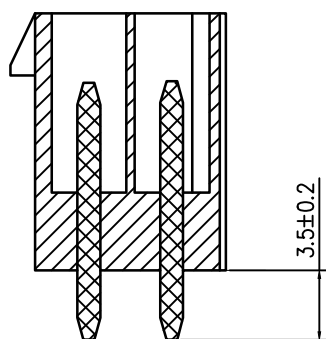

SECTION A-A

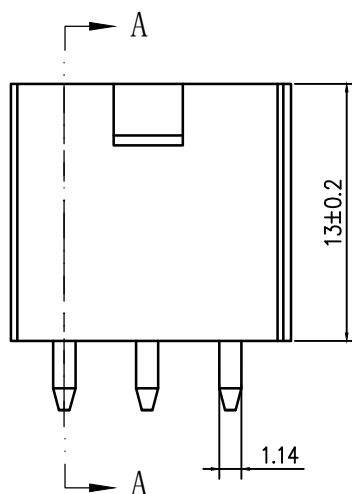
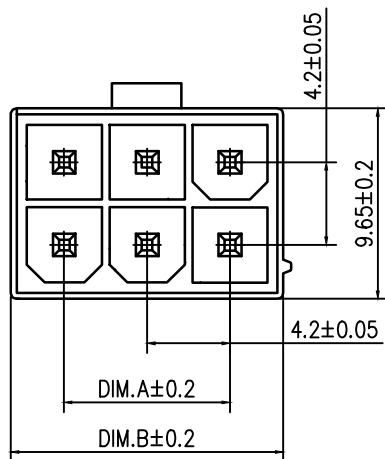
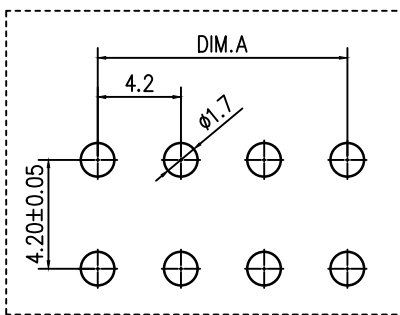

技术要求:

适用基板厚度: 1.6mm~2.0mm

温度范围: -25℃~85℃

额定电压: 300V AC/DC

额定电流: 7A

接触电阻: ≤0.015 Ω

绝缘电阻: ≥1000M Ω

耐 压: 1000V AC/minute

2	插针	铜	镀锡	
1	底座	PA66	本色	
序号	品名	材质	电镀/颜色	备注

	深圳市虹成电子有限公司		品名 TITLE	针座	
			料号 PART NO	HC-5569-2x4A (P)	
GENERAL TOLERANCES (UNLESS SPECIFIED)			比列 SCALE	1:1	
X.X ±0.35	X' ±3.00'	单位 UNIT	MM	制图 DRAW	AhYe
X.XX ±0.25	X.X' ±2.00'	张数 PART NO	1 OF 1	审核 CHECKED	夏操云
X.XXX ±0.15	X.XX' ±1.00'	版本 REV	A	批准 APPROVE	赵亮亮