

标记 MARK	ECN编号/变更内容 ECN NO/DEFINITION	修改 REVISE	日期 DATE	核准 APPROVE

Pin	DIM A	DIM B
2	7.50	0.00
3	10.00	2.50
4	12.50	5.00
5	15.00	7.50
6	17.50	10.00
7	20.00	12.50
8	22.50	15.00
9	25.00	17.50
10	27.50	20.00
11	30.00	22.50
12	32.50	25.00
13	35.00	27.50
14	37.50	30.00
15	40.00	32.50
16	42.50	35.00

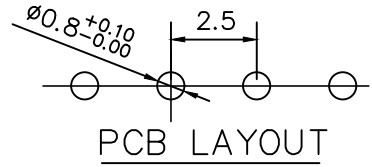
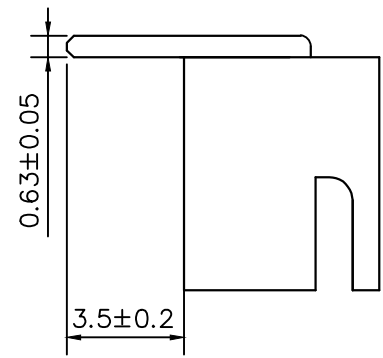
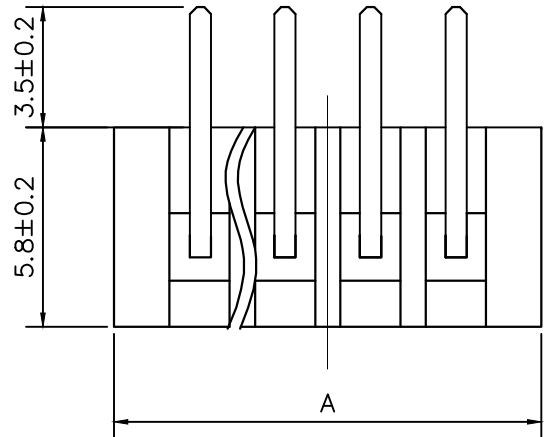
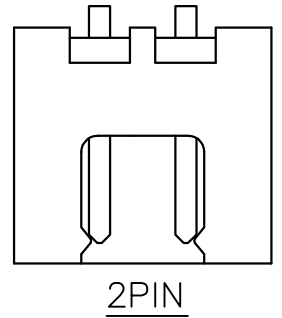
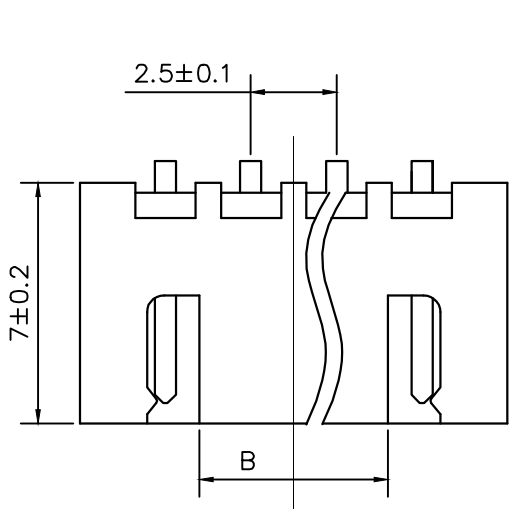

技术要求:

- 适应基板厚度: 1.2mm~1.6mm
- 温度范围: -25℃~85℃
- 额定电压: 250V AC/DC
- 额定电流: 3A
- 接触电阻: $\leq 0.01 \Omega$
- 绝缘电阻: $\geq 1000M \Omega$
- 耐压: 1000V AC/minute

2	插针	铜	镀锡	
1	基座	PA66	米色	
序号	品名	材质	电镀/颜色	备注

	深圳市虹成电子有限公司		品名 TITLE	针座	
			料号 PART NO	HC-XH2.54-7AW-M	
GENERAL TOLERANCES (UNLESS SPECIFIED)		比列 SCALE	1:1		
X.X ±0.35	X' ±3.00"	单位 UNIT	MM		
X.XX ±0.25	X.X' ±2.00"	张数 PART NO	1 OF 1	制图 DRAW	AhYe
X.XXX ±0.15	X.XX' ±1.00"	版本 REV	A	审核 CHECKED	夏操云
				批准 APPROVE	赵亮亮

