



### Features

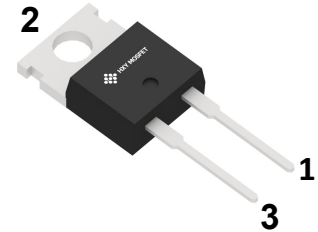
- High frequency operation
- High surge forward current capability
- High purity, high temperature epoxy encapsulation for enhanced mechanical strength and moisture resistance
- Guard ring for enhanced ruggedness and long term reliability
- Solder dip 275 °C max. 7 s, per JESD 22-B106

### Typical Applications

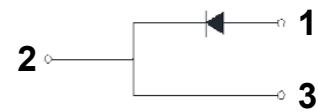
Typical applications are in switching power supplies, converters, freewheeling diodes, and reverse battery protection.

### Mechanical Data

- **Package:** TO-220C-2L  
Molding compound meets UL 94 V-0 flammability rating, RoHS-compliant
- **Terminals:** Tin plated leads, solderable per J-STD-002 and JESD22-B102
- **Polarity:** As marked



TO-220C-2L



### Maximum Ratings (Ta=25°C unless otherwise specified)

Parameter	Symbol	Limit	Unit
Repetitive Peak Reverse Voltage	V <sub>RRM</sub>	600	V
Average Rectified Output Current @60Hz half sine-wave, R-load, T <sub>c</sub>	I <sub>o</sub>	8	A
Surge(Non-repetitive)Forward Current @60Hz half sine-wave, 1 cycle, Ta=25°C	I <sub>FSM</sub>	100	A
Current Squared Time @ 1ms≤t≤8.3ms T <sub>j</sub> =25°C	I <sup>2</sup> t	41	A <sup>2</sup> s
Storage Temperature	T <sub>stg</sub>	-55 ~ +150	°C
Junction Temperature	T <sub>j</sub>	-55 ~ +150	°C

### Electrical Characteristics(Ta=25°C unless otherwise specified)

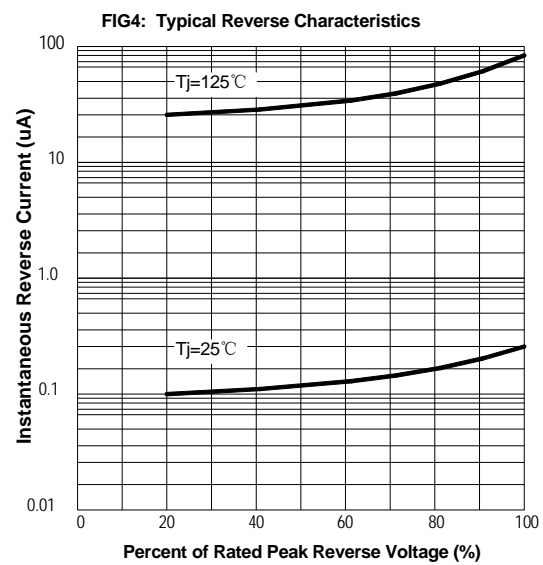
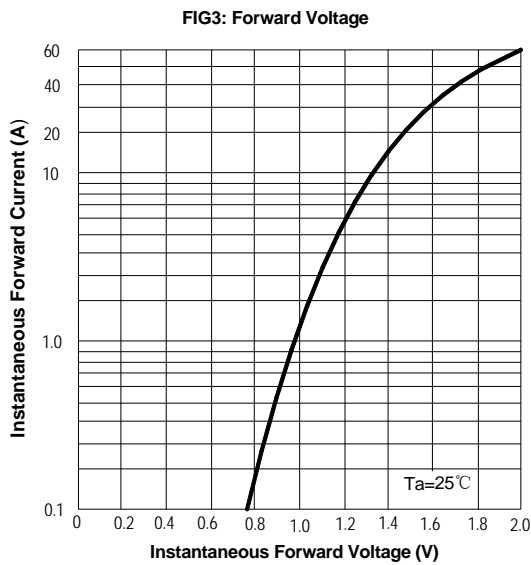
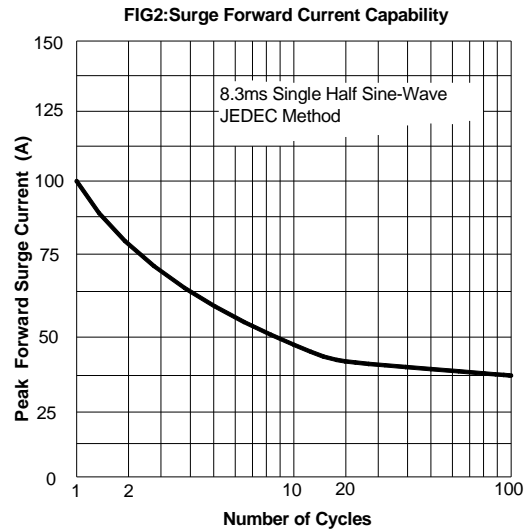
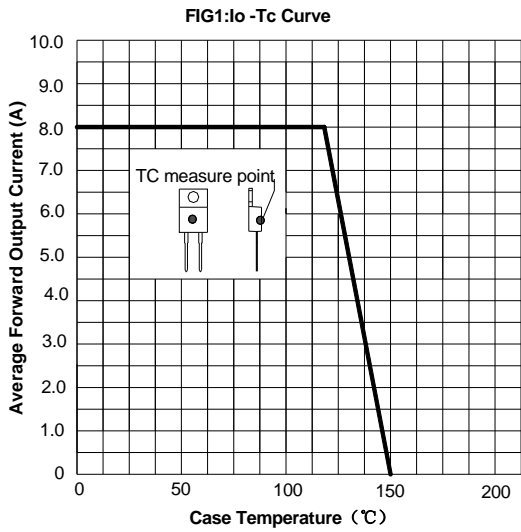
Parameter	Symbol	Test Conditions	Limit	Unit
Maximum instantaneous forward voltage drop per diode	V <sub>FM</sub>	I <sub>FM</sub> =8.0A	1.5	V
Maximum DC reverse current at rated DC blocking voltage per diode	I <sub>RRM1</sub>	V <sub>RM</sub> =V <sub>RRM</sub> Ta=25°C	10	uA
	I <sub>RRM2</sub>	V <sub>RM</sub> =V <sub>RRM</sub> Ta=125°C	500	
Reverse Recovery Time	T <sub>rr</sub>	I <sub>F</sub> =0.5A I <sub>RM</sub> =1A I <sub>RR</sub> =0.25A	50	ns

### Thermal Characteristics (Ta=25°C unless otherwise specified)

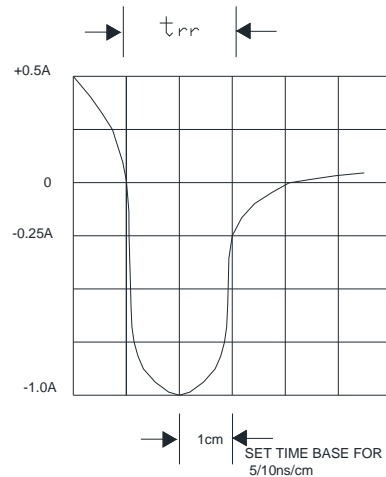
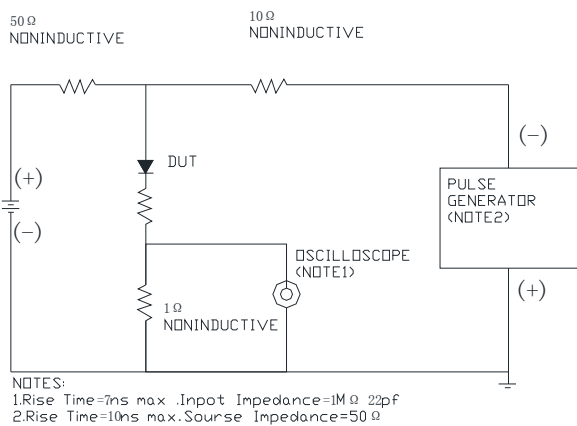
Parameter	Symbol	Limit	Unit
Thermal Resistance Between junction and case	R <sub>θJ-C</sub>	2.0	°CW



### Characteristics (Typical)

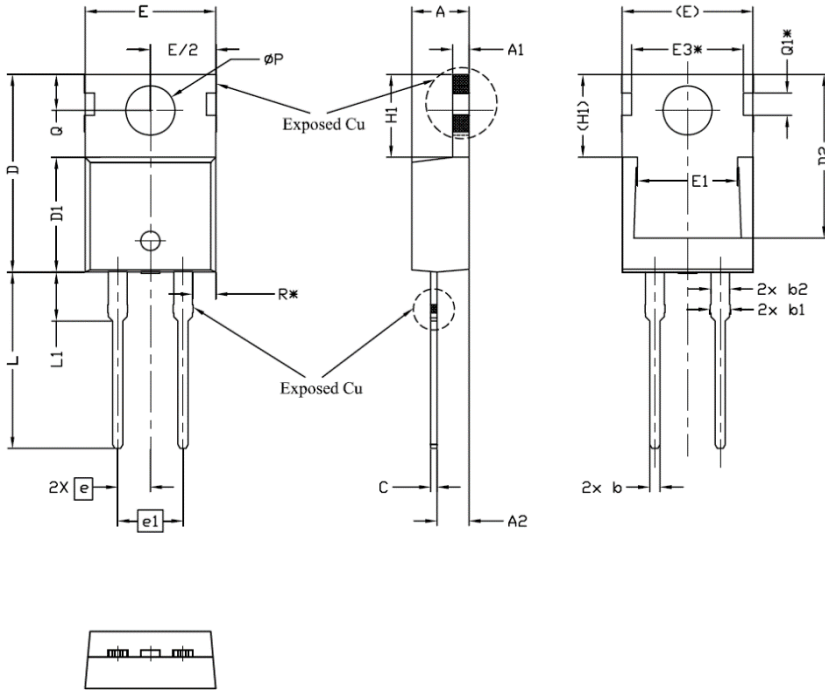


**FIG.5 Diagram of circuit and Testing wave form of reverse recovery time**





Package Information  
TO-220C-2L



SYMBOL	DIMENSIONS			NOTES
	MIN.	NOM.	MAX.	
A	4.24	4.44	4.64	
A1	1.15	1.27	1.40	
A2	2.30	2.48	2.70	
b	0.70	0.80	0.90	
b1	1.20	1.55	1.75	
b2	1.20	1.45	1.70	
c	0.40	0.50	0.60	
D	14.70	15.37	16.00	4
D1	8.82	8.92	9.02	
D2	12.43	12.73	12.83	5
E	9.96	10.16	10.36	4,5
E1	6.86	7.77	8.89	5
E3*	8.70REF.			
e	2.54BSC			
e1	5.08BSC			
H1	6.30	6.45	6.60	5,6
L	13.47	13.72	13.97	
L1	3.60	3.80	4.00	
$\varnothing P$	3.75	3.84	3.93	
Q	2.60	2.80	3.00	
Q1*	1.73REF.			
R*	1.82REF.			



### Attention

- Any and all HUA XUAN YANG ELECTRONICS products described or contained herein do not have specifications that can handle applications that require extremely high levels of reliability, such as life-support systems, aircraft's control systems, or other applications whose failure can be reasonably expected to result in serious physical and/or material damage. Consult with your HUA XUAN YANG ELECTRONICS representative nearest you before using any HUA XUAN YANG ELECTRONICS products described or contained herein in such applications.
- HUA XUAN YANG ELECTRONICS assumes no responsibility for equipment failures that result from using products at values that exceed, even momentarily, rated values (such as maximum ratings, operating condition ranges, or other parameters) listed in products specifications of any and all HUA XUAN YANG ELECTRONICS products described or contained herein.
- Specifications of any and all HUA XUAN YANG ELECTRONICS products described or contained herein stipulate the performance, characteristics, and functions of the described products in the independent state, and are not guarantees of the performance, characteristics, and functions of the described products as mounted in the customer's products or equipment. To verify symptoms and states that cannot be evaluated in an independent device, the customer should always evaluate and test devices mounted in the customer's products or equipment.
- HUA XUAN YANG ELECTRONICS CO.,LTD. strives to supply high-quality high-reliability products. However, any and all semiconductor products fail with some probability. It is possible that these probabilistic failures could give rise to accidents or events that could endanger human lives, that could give rise to smoke or fire, or that could cause damage to other property. When designing equipment, adopt safety measures so that these kinds of accidents or events cannot occur. Such measures include but are not limited to protective circuits and error prevention circuits for safe design, redundant design, and structural design.
- In the event that any or all HUA XUAN YANG ELECTRONICS products(including technical data, services) described or contained herein are controlled under any of applicable local export control laws and regulations, such products must not be exported without obtaining the export license from the authorities concerned in accordance with the above law.
- No part of this publication may be reproduced or transmitted in any form or by any means, electronic or mechanical, including photocopying and recording, or any information storage or retrieval system, or otherwise, without the prior written permission of HUA XUAN YANG ELECTRONICS CO.,LTD.
- Information (including circuit diagrams and circuit parameters) herein is for example only ; it is not guaranteed for volume production. HUA XUAN YANG ELECTRONICS believes information herein is accurate and reliable, but no guarantees are made or implied regarding its use or any infringements of intellectual property rights or other rights of third parties.
- Any and all information described or contained herein are subject to change without notice due to product/technology improvement, etc. When designing equipment, refer to the "Delivery Specification" for the HUA XUAN YANG ELECTRONICS product that you intend to use.