



Features

- 650-Volt Schottky Rectifier
- Zero Reverse Recovery Current
- Zero Forward Recovery Voltage
- High-Frequency Operation
- Temperature-Independent Switching Behavior
- Extremely Fast Switching
- Positive Temperature Coefficient on V_F

Benefits

- Replace Bipolar with Unipolar Rectifiers
- Essentially No Switching Losses
- Higher Efficiency
- Reduction of Heat Sink Requirements
- Parallel Devices Without Thermal Runaway

Applications

- Switch Mode Power Supplies
- Power Factor Correction
- Motor Drives



| Part Number | Package | Brand |
|--------------|------------|------------|
| WN5C2D10650Q | TO-220C-2L | HXY MOSFET |

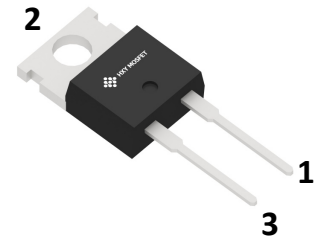

TO-220C-2L

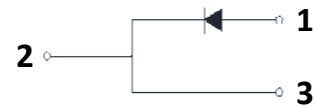

Maximum Ratings ($T_C = 25^\circ\text{C}$ unless otherwise specified)

| Symbol | Parameter | Value | Unit | Test Conditions | Note |
|----------------|--------------------------------------------|------------------|------------------|-------------------------------------------------------------------------------------------------------------------------|--------|
| V_{RRM} | Repetitive Peak Reverse Voltage | 650 | V | | |
| V_{RSM} | Surge Peak Reverse Voltage | 650 | V | | |
| V_{DC} | DC Blocking Voltage | 650 | V | | |
| I_F | Continuous Forward Current | 30 14.5 10 | A | $T_C=25^\circ\text{C}$ $T_C=135^\circ\text{C}$ $T_C=153^\circ\text{C}$ | Fig. 3 |
| I_{FRM} | Repetitive Peak Forward Surge Current | 46 31 | A | $T_C=25^\circ\text{C}$, $t_p = 10$ ms, Half Sine Wave $T_C=110^\circ\text{C}$, $t_p = 10$ ms, Half Sine Wave | |
| I_{FSM} | Non-Repetitive Peak Forward Surge Current | 90 71 | A | $T_C=25^\circ\text{C}$, $t_p = 10$ ms, Half Sine Wave $T_C=110^\circ\text{C}$, $t_p = 10$ ms, Half Sine Wave | Fig. 8 |
| I_{FMax} | Non-Repetitive Peak Forward Surge Current | 860 680 | A | $T_C=25^\circ\text{C}$, $t_p = 10$ μs , Pulse $T_C=110^\circ\text{C}$, $t_p = 10$ μs , Pulse | Fig. 8 |
| P_{tot} | Power Dissipation | 136.5 59 | W | $T_C=25^\circ\text{C}$ $T_C=110^\circ\text{C}$ | Fig. 4 |
| T_J, T_{stg} | Operating Junction and Storage Temperature | -55 to +175 | $^\circ\text{C}$ | | |
| | TO-220 Mounting Torque | 1 8.8 | Nm lbf-in | M3 Screw 6-32 Screw | |



Electrical Characteristics

| Symbol | Parameter | Typ. | Max. | Unit | Test Conditions | Note |
|--------|---------------------------|-------------------|------------|---------------|--------------------------------------------------------------------------------------------------------------------------------------------------------------------------------------------------------------------|--------|
| V_F | Forward Voltage | 1.5 2.0 | 1.8 2.4 | V | $I_F = 10\text{ A}$ $T_J = 25^\circ\text{C}$ $I_F = 10\text{ A}$ $T_J = 175^\circ\text{C}$ | Fig. 1 |
| I_R | Reverse Current | 12 24 | 60 220 | μA | $V_R = 650\text{ V}$ $T_J = 25^\circ\text{C}$ $V_R = 650\text{ V}$ $T_J = 175^\circ\text{C}$ | Fig. 2 |
| Q_C | Total Capacitive Charge | 24 | | nC | $V_R = 400\text{ V}$, $I_F = 10\text{ A}$ $di/dt = 500\text{ A}/\mu\text{s}$ $T_J = 25^\circ\text{C}$ | Fig. 5 |
| C | Total Capacitance | 460.5 44 40 | | pF | $V_R = 0\text{ V}$, $T_J = 25^\circ\text{C}$, $f = 1\text{ MHz}$ $V_R = 200\text{ V}$, $T_J = 25^\circ\text{C}$, $f = 1\text{ MHz}$ $V_R = 400\text{ V}$, $T_J = 25^\circ\text{C}$, $f = 1\text{ MHz}$ | Fig. 6 |
| E_C | Capacitance Stored Energy | 3.6 | | μJ | $V_R = 400\text{ V}$ | Fig. 7 |

Note: This is a majority carrier diode, so there is no reverse recovery charge.

Thermal Characteristics

| Symbol | Parameter | Typ. | Unit | Note |
|-----------------|------------------------------------------|------|---------------------------|--------|
| $R_{\theta JC}$ | Thermal Resistance from Junction to Case | 1.1 | $^\circ\text{C}/\text{W}$ | Fig. 9 |

Typical Performance

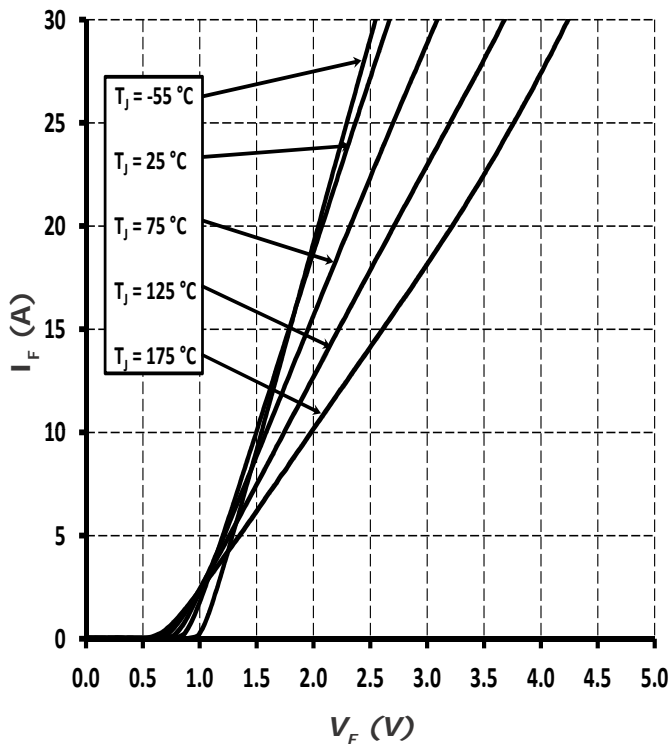

Figure 1. Forward Characteristics

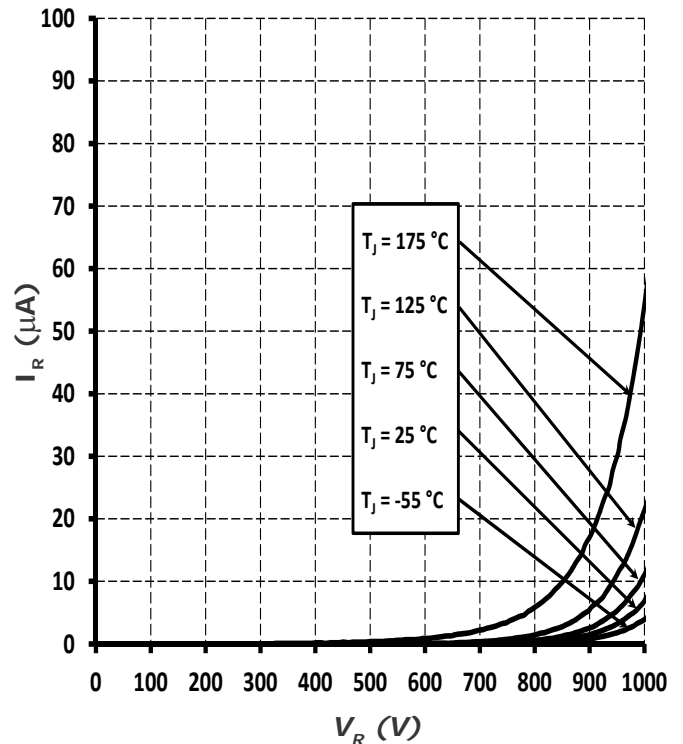

Figure 2. Reverse Characteristics



Typical Performance

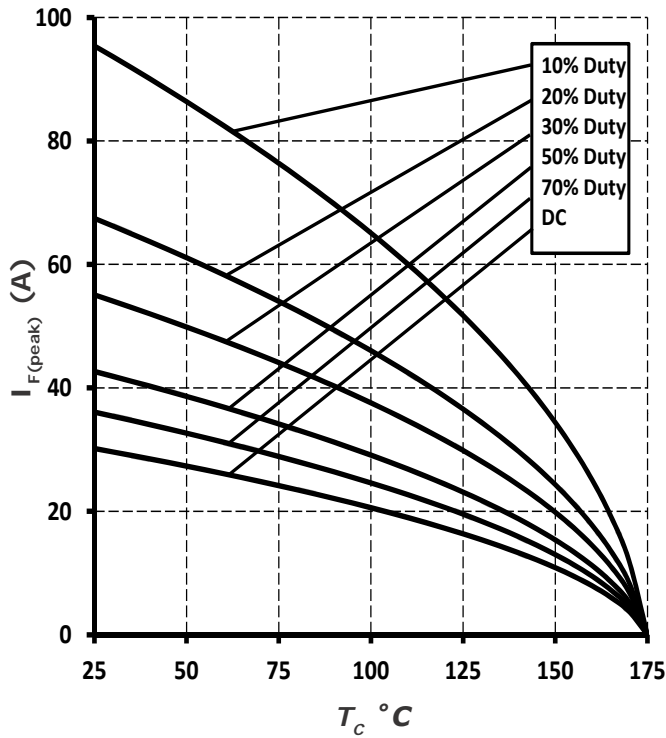

Figure 3. Current Derating

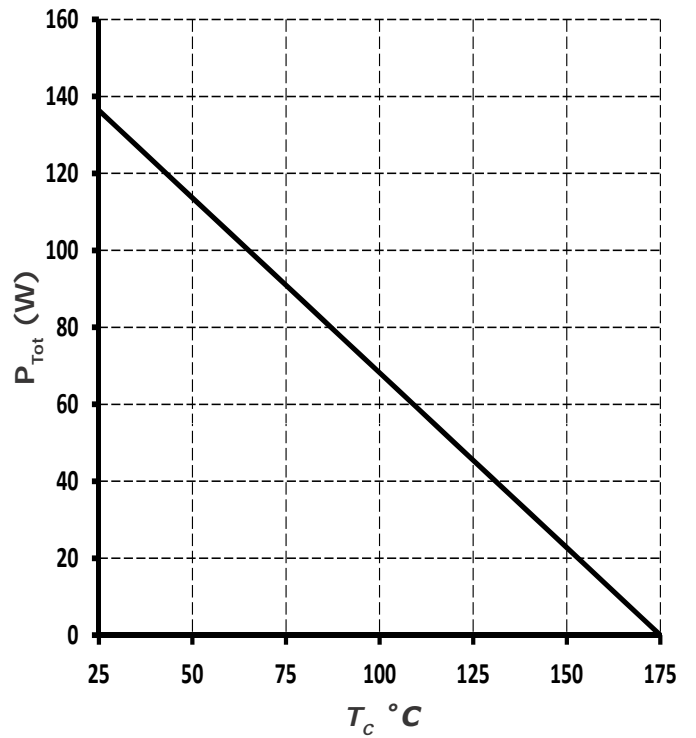

Figure 4. Power Derating

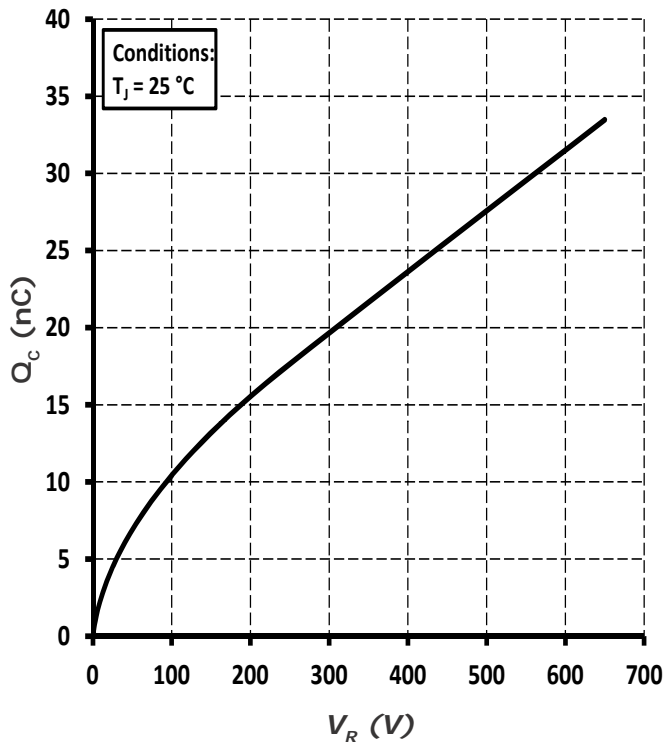

Figure 5. Total Capacitance Charge vs. Reverse Voltage

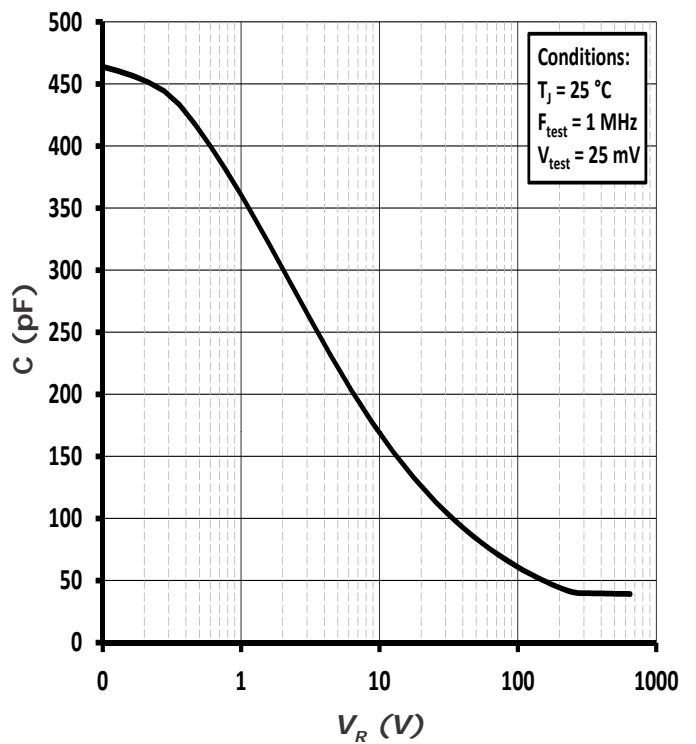

Figure 6. Capacitance vs. Reverse Voltage



Typical Performance

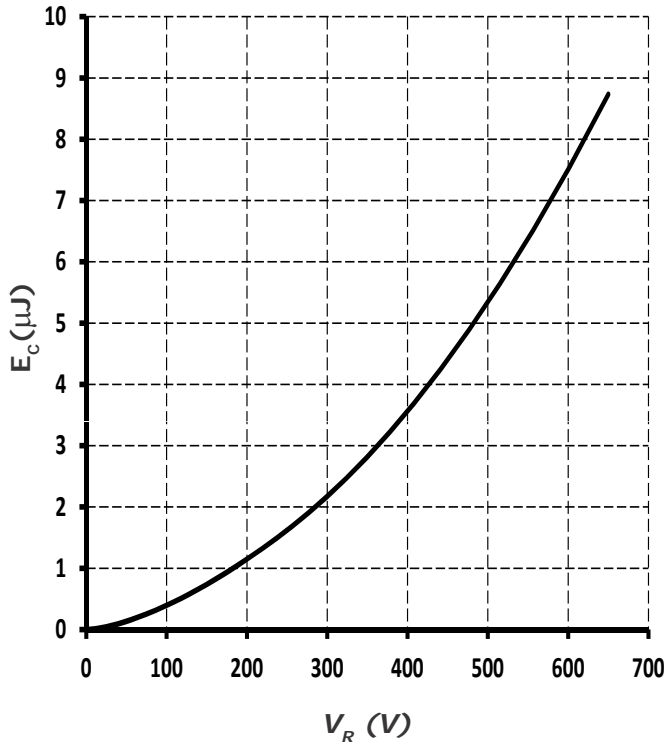

Figure 7. Capacitance Stored Energy

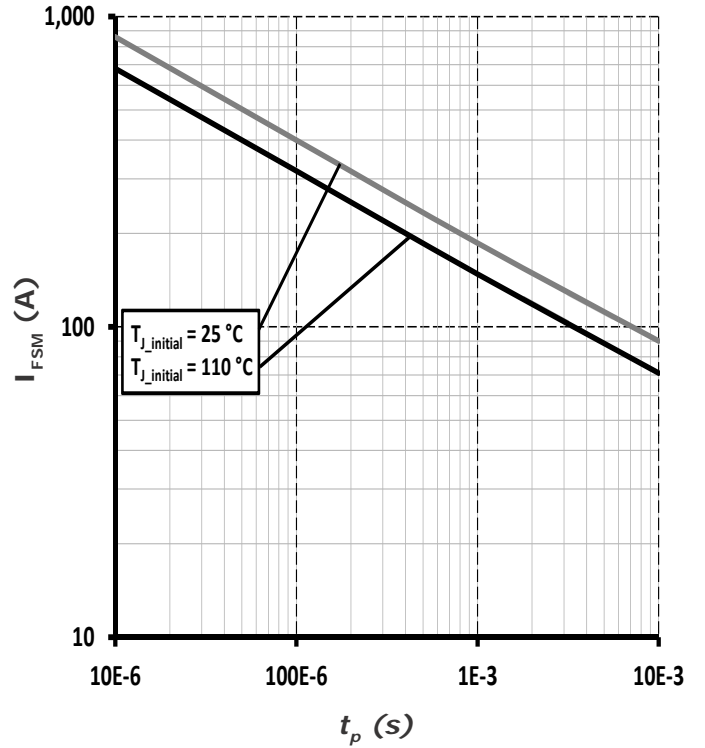

Figure 8. Non-repetitive peak forward surge current versus pulse duration (sinusoidal waveform)

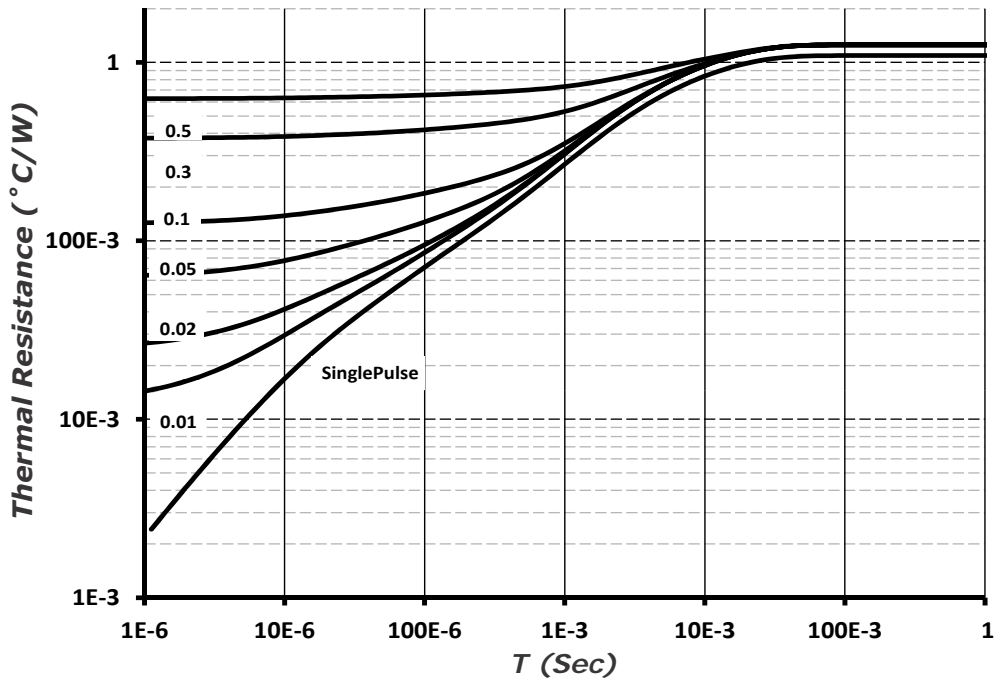
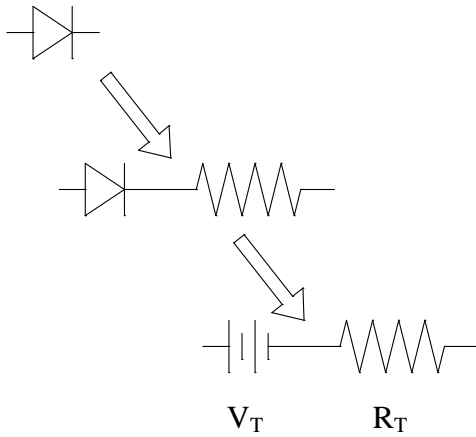

Figure 9. Transient Thermal Impedance



Diode Model



$$V_{fT} = V_T + I_f * R_T$$

$$V_T = 0.94 + (T_J * -1.3 * 10^{-3})$$

$$R_T = 0.044 + (T_J * 4.4 * 10^{-4})$$

Note: T_J = Diode Junction Temperature In Degrees Celsius,
valid from 25°C to 175°C



Package Information
TO-220C-2L

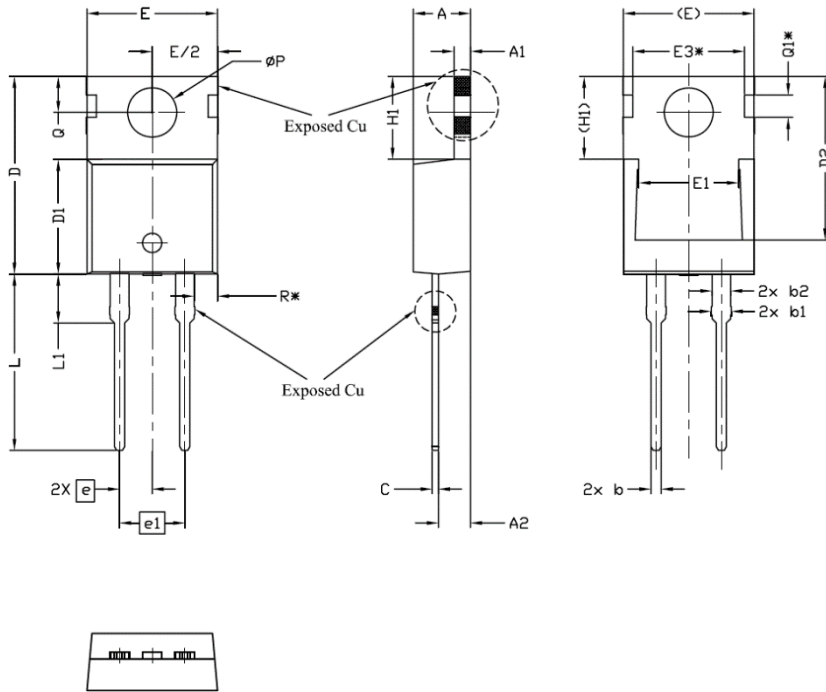

| SYMBOL | DIMENSIONS | | | NOTES |
|--------|------------|-------|-------|-------|
| | MIN. | NOM. | MAX. | |
| A | 4,24 | 4,44 | 4,64 | |
| A1 | 1,15 | 1,27 | 1,40 | |
| A2 | 2,30 | 2,48 | 2,70 | |
| b | 0,70 | 0,80 | 0,90 | |
| b1 | 1,20 | 1,55 | 1,75 | |
| b2 | 1,20 | 1,45 | 1,70 | |
| c | 0,40 | 0,50 | 0,60 | |
| D | 14,70 | 15,37 | 16,00 | 4 |
| D1 | 8,82 | 8,92 | 9,02 | |
| D2 | 12,43 | 12,73 | 12,83 | 5 |
| E | 9,96 | 10,16 | 10,36 | 4,5 |
| E1 | 6,86 | 7,77 | 8,89 | 5 |
| E3* | 8,70REF. | | | |
| e | 2,54BSC | | | |
| e1 | 5,08BSC | | | |
| H1 | 6,30 | 6,45 | 6,60 | 5,6 |
| L | 13,47 | 13,72 | 13,97 | |
| L1 | 3,60 | 3,80 | 4,00 | |
| ∅P | 3,75 | 3,84 | 3,93 | |
| Q | 2,60 | 2,80 | 3,00 | |
| Q1* | 1,73REF. | | | |
| R* | 1,82REF. | | | |

Recommended Solder Pad Layout

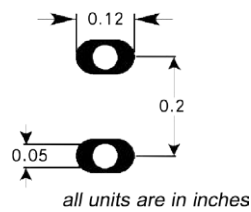



Attention

- Any and all HUA XUAN YANG ELECTRONICS products described or contained herein do not have specifications that can handle applications that require extremely high levels of reliability, such as life-support systems, aircraft's control systems, or other applications whose failure can be reasonably expected to result in serious physical and/or material damage. Consult with your HUA XUAN YANG ELECTRONICS representative nearest you before using any HUA XUAN YANG ELECTRONICS products described or contained herein in such applications.

- HUA XUAN YANG ELECTRONICS assumes no responsibility for equipment failures that result from using products at values that exceed, even momentarily, rated values (such as maximum ratings, operating condition ranges, or other parameters) listed in products specifications of any and all HUA XUAN YANG ELECTRONICS products described or contained herein.

- Specifications of any and all HUA XUAN YANG ELECTRONICS products described or contained herein stipulate the performance, characteristics, and functions of the described products in the independent state, and are not guarantees of the performance, characteristics, and functions of the described products as mounted in the customer's products or equipment. To verify symptoms and states that cannot be evaluated in an independent device, the customer should always evaluate and test devices mounted in the customer's products or equipment.

- HUA XUAN YANG ELECTRONICS CO.,LTD. strives to supply high-quality high-reliability products. However, any and all semiconductor products fail with some probability. It is possible that these probabilistic failures could give rise to accidents or events that could endanger human lives, that could give rise to smoke or fire, or that could cause damage to other property. When designing equipment, adopt safety measures so that these kinds of accidents or events cannot occur. Such measures include but are not limited to protective circuits and error prevention circuits for safe design, redundant design, and structural design.

- In the event that any or all HUA XUAN YANG ELECTRONICS products(including technical data, services) described or contained herein are controlled under any of applicable local export control laws and regulations, such products must not be exported without obtaining the export license from the authorities concerned in accordance with the above law.

- No part of this publication may be reproduced or transmitted in any form or by any means, electronic or mechanical, including photocopying and recording, or any information storage or retrieval system, or otherwise, without the prior written permission of HUA XUAN YANG ELECTRONICS CO.,LTD.

- Information (including circuit diagrams and circuit parameters) herein is for example only ; it is not guaranteed for volume production. HUA XUAN YANG ELECTRONICS believes information herein is accurate and reliable, but no guarantees are made or implied regarding its use or any infringements of intellectual property rights or other rights of third parties.

- Any and all information described or contained herein are subject to change without notice due to product/technology improvement, etc. When designing equipment, refer to the "Delivery Specification" for the HUA XUAN YANG ELECTRONICS product that you intend to use.