

Electro-Static Discharge TUSD05EB Bidirectional TVS Diode

SOD-523

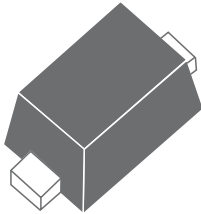

Pin Configuration

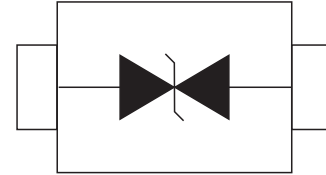

Features

- Ultra Low Capacitance 0.5 pF
- Low Clamping Voltage
- Small Body Outline Dimensions
- Stand-off Voltage: 5 V
- Low Leakage
- Response Time is Typically < 1.0 ns
- IEC61000-4-2 Level 4 ESD Protection
- We declare that the material of product compliant with RoHS requirements and Halogen Free.

IEC Compatibility

- IEC61000-4-2 (ESD) ±15kV (air), ±8kV (contact)

Mechanical Characteristics

- SOD-523 Package
- Molding Compound Flammability Rating:L 94V-O
- Quantity Per Reel:3000pcs
- Reel Size:7 inch
- Lead Finish:Lead Free

Maximum Ratings($T_A=25^{\circ}\text{C}$ unless otherwise noted)

Maximum Ratings(@ 25°C Unless Otherwise Specified)			
Parameter	Symbol	Value	Units
Peak Pulse Power($t_p=8/20\mu\text{s}$ waveform)	P_{PP}	100	Watts
Lead Soldering Temperature	T_L	260(10 sec.)	$^{\circ}\text{C}$
Junction Temperature Range	T_J	-55~125	$^{\circ}\text{C}$
Storage Temperature Range	T_{STG}	-55~150	$^{\circ}\text{C}$

Electrical Characteristics(Ta=25°C unless otherwise specified)

TUSD05EB(Marking: L5)

Parameter	Symbol	Conditions	Min.	Typ.	Max.	Units
Reverse Stand-off Voltage	V_{RWM}	Pin 2-1 / Pin1-2			5	V
Reverse Breakdown Voltage	V_{BR}	$I_z=1mA$ Pin to Pin	5.4			V
Reverse Leakage Current	I_R	@ V_{RWM}			1	μA
Clamping Voltage	V_C	$I_{PP}=5A, t_p=8/20\mu s$			12.9	V
Peak Pulse Current	I_{PP}	$t_p=8/20\mu s$			5	A
Junction Capacitance	$C_{I/O}$	0Vdc, f=1MHz Between I/O Pins and GND		0.5	0.9	pF

Ratings and Characteristic Curves

Fig.1 ESD Clamping Voltage Screenshot Positive 8 kV Contact per IEC61000-4-2

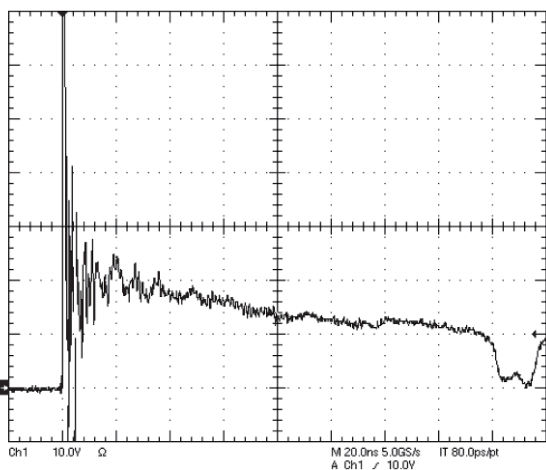

Fig.2 ESD Clamping Voltage Screenshot Negative 8 kV Contact per IEC61000-4-2

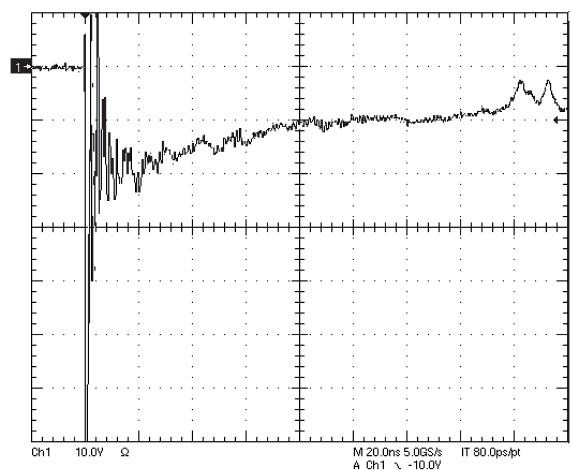

Fig.3 Reverse Character

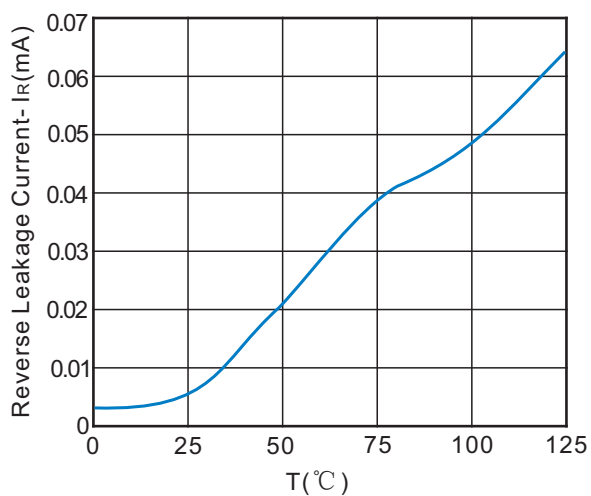
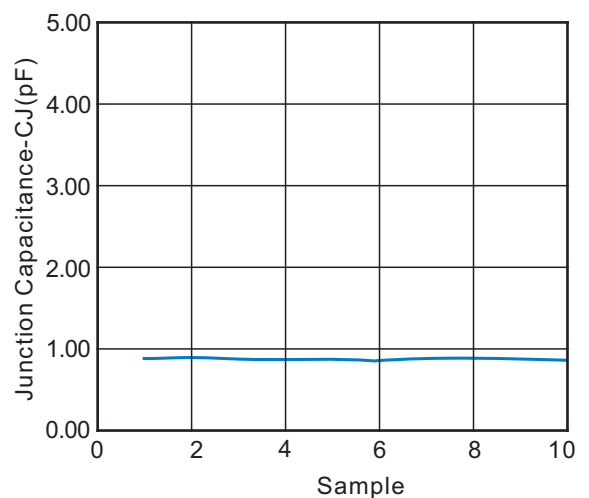
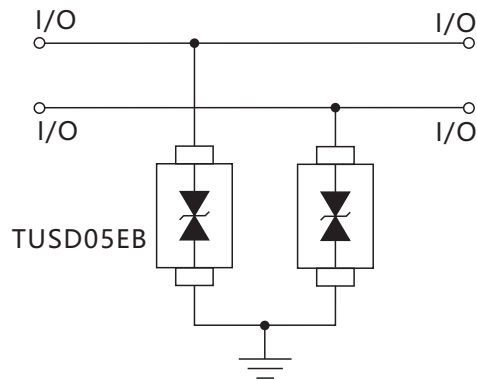

Fig.4 Capacitance Character



Application

I/O Protection



Dimensions(SOD-523)

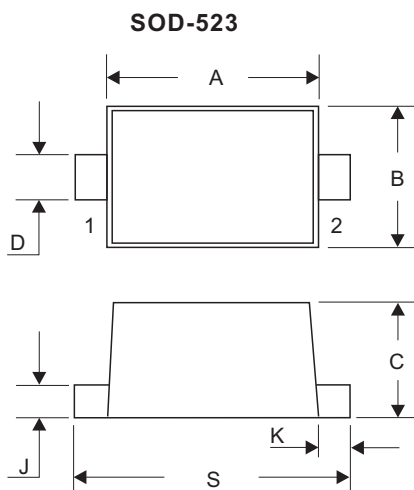

DIM	Millimeters		Inches	
	Min	Max	Min	Max
A	1.10	1.30	0.043	0.051
B	0.70	0.90	0.028	0.035
C	0.50	0.70	0.020	0.028
D	0.25	0.35	0.010	0.014
J	0.07	0.20	0.0028	0.0079
K	0.15	0.25	0.006	0.010
S	1.50	1.70	0.059	0.067

Recommended Mounting Pad Layout

