

Product Summary

- VCBO = 50V
- VCEO = 50V
- IC = 100mA
- R1 = 10kΩ

Features

- Built-in bias resistors
- making device design easy
- almost completely eliminating parasitic effects

Circuit diagram and pin information

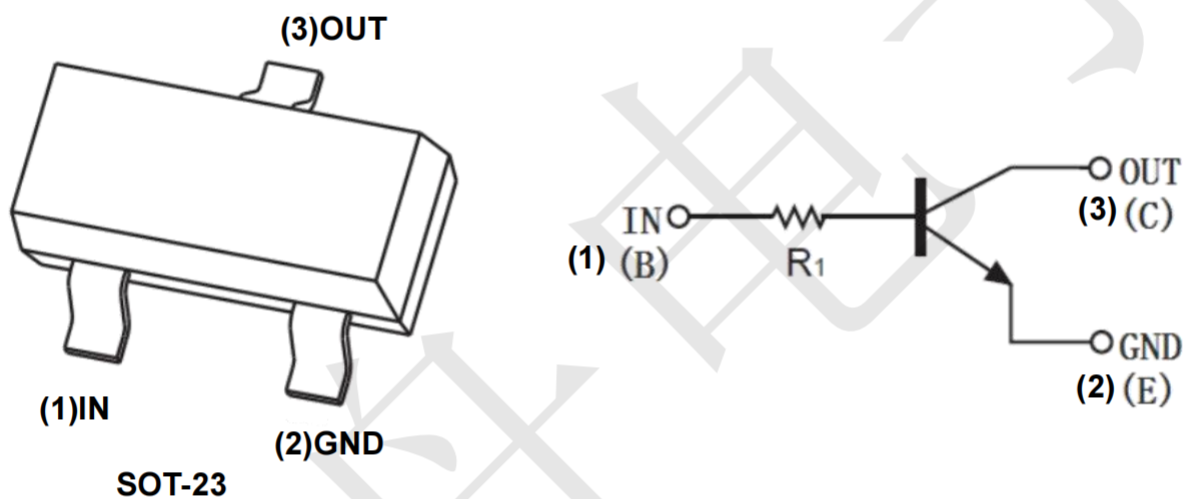

Absolute Maximum Ratings

(Ta=25°C unless otherwise specified)

PARAMETER	SYMBOL	LIMIT	UNIT
Collector-Base Voltage	VCBO	50	V
Collector-Emitter Voltage	VCEO	50	V
Emitter-Base Voltage	VEBO	5V	V
Collector current	IC	100	mA
Power Total Dissipation @ TA=25°C	P _D	200	mW
Maximum Operating Junction Temperature	T _J	+150	°C
Storage Temperature Range	TSTG	-55 to +150	°C

Electrical Characteristics

(TA=25°C unless otherwise specified)

Parameter	Symbol	Conditions	Min	Typ	Max	Unit
Collector-base breakdown voltage	$V_{(BR)CBO}$	$I_C=50\mu A, I_E=0$	50	--	--	V
Collector-emitter breakdown voltage	$V_{(BR)CEO}$	$I_C=1mA, I_B=0$	50	--	--	V
Emitter-base breakdown voltage	$V_{(BR)EBO}$	$I_E=50\mu A, I_C=0$	5	--	--	V
Collector cut-off current	I_{CBO}	$V_{CB}=50V, I_E=0$	--	--	0.5	μA
Emitter cut-off current	I_{EBO}	$V_{EB}=4V, I_C=0$	--	--	0.5	μA
Collector-emitter saturation voltage	$V_{CE(sat)}$	$I_C=5mA, I_B=0.5mA$	--	--	0.3	V
DC current gain	h_{FE}	$V_{CE}=5V, I_C=1mA$	100	300	600	--
Input resistor	R_1		7	10	13	k Ω
Transition frequency	f_T	$V_{CE}=10V, I_E=5mA,$ $f=100MHz$	--	250	--	MHz

Note:

- 1.Characteristics of built-in transistor
- 2.Each terminal mounted on a reference land

Typical Performance Characteristics(TA=25°C)

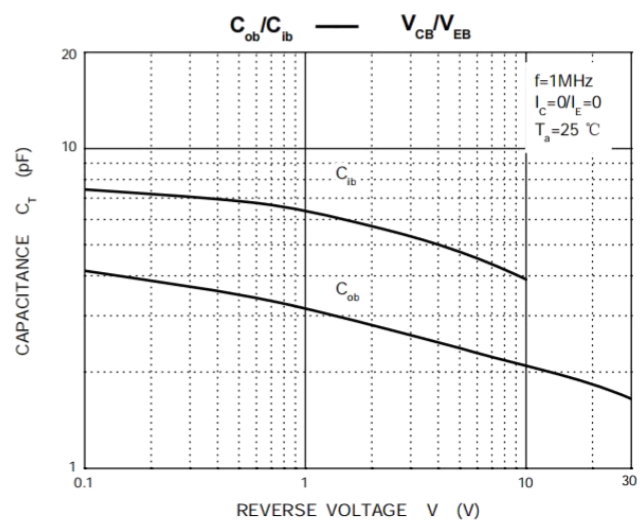
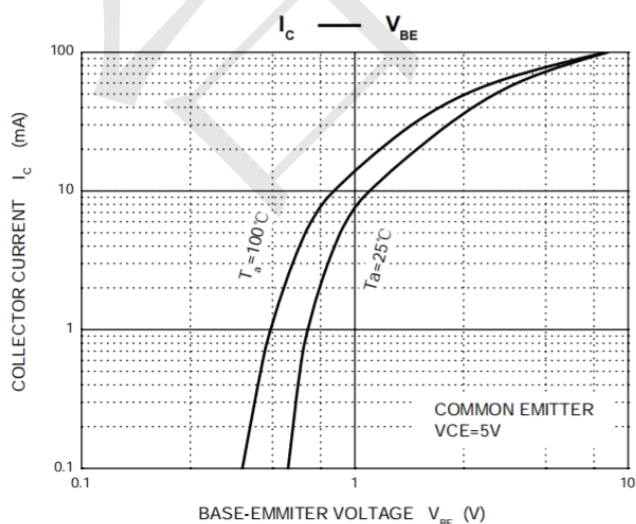
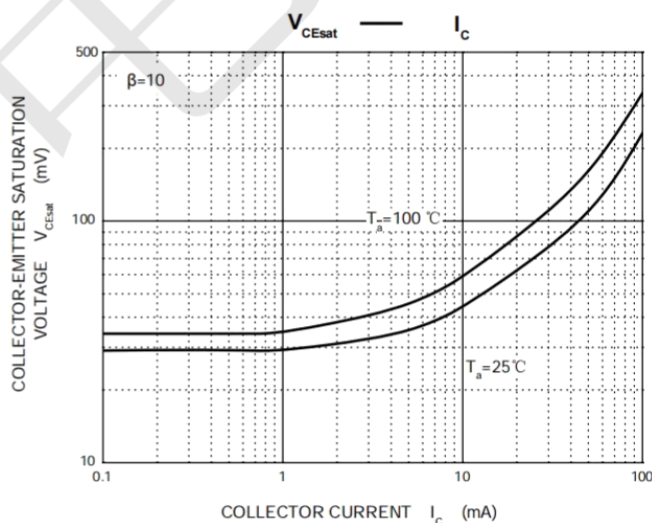
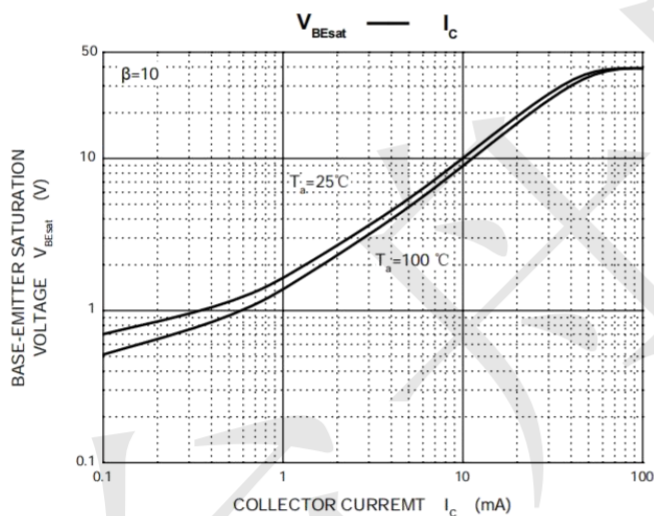
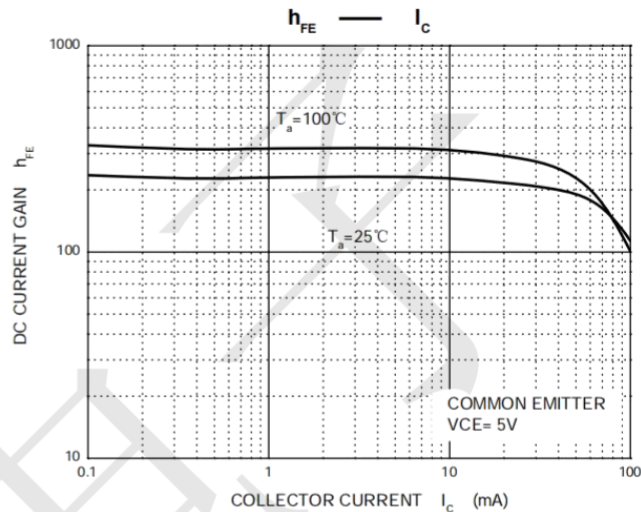
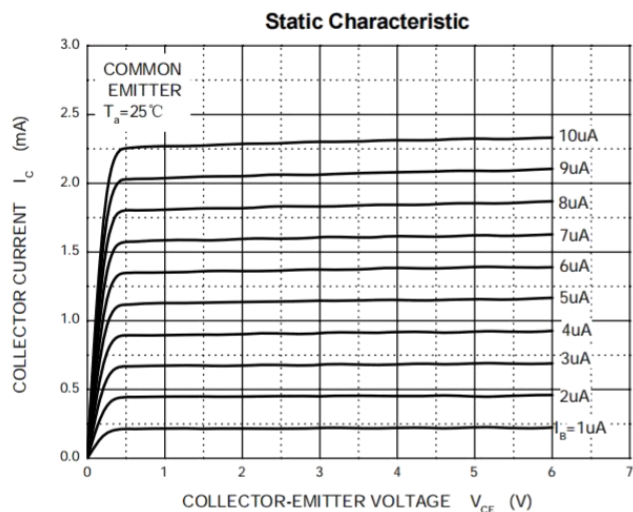

Package Outline Dimensions (unit: mm)

SOT-23

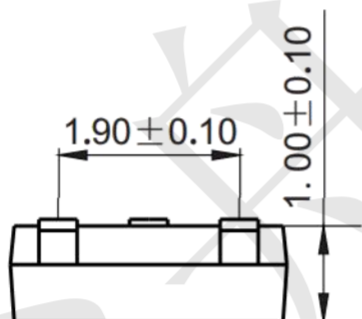
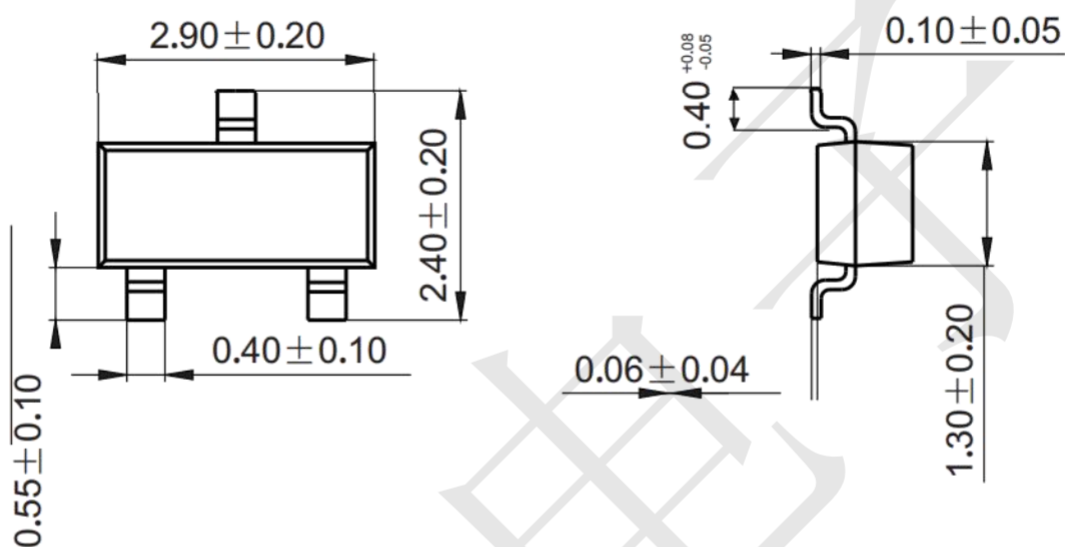

Mounting Pad Layout (unit: mm)

