



Features

- High Speed Switching with Low Capacitances
- High Blocking Voltage with Low $R_{DS(on)}$
- Easy to parallel
- Simple to drive
- RoHS Compliant

Benefits

- Increased Power Density
- Faster Operating Frequency
- Reduction of Heat Sink Requirements
- Higher Efficiency
- Reduced EMI

Applications

- Power Factor Correction Modules
- Switch Mode Power Supplies
- DC-AC Inverters
- High Voltage DC/DC Converters

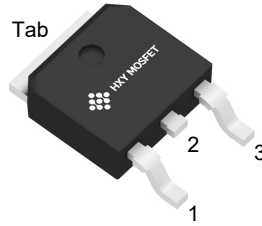

TO-252-2L

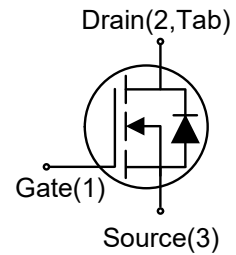

Ordering Part Number	Package	Brand
IPD60R400CEAUMA1	TO-252-2L	HXY MOSFET

Maximum Ratings ($T_c = 25^\circ\text{C}$ unless otherwise specified)

Symbol	Parameter	Value	Unit	Test Conditions
V_{DSmax}	Drain - Source Voltage	650	V	$V_{GS} = 0\text{ V}$, $I_D = 100\ \mu\text{A}$
V_{GSmax}	Gate - Source Voltage (dynamic)	-5/+26	V	AC ($f > 1\text{ Hz}$)
V_{GSop}	Gate - Source Voltage (static)	0/+18	V	Static
I_D	Continuous Drain Current	15	A	$T_C = 25^\circ\text{C}$
		12		$T_C = 100^\circ\text{C}$
I_{DM}	Pulsed Drain Current	39	A	Pulse width t_p limited by T_{Jmax}
P_D	Power Dissipation	52	W	$T_C = 25^\circ\text{C}$
		25		$T_C = 100^\circ\text{C}$
T_J, T_{stg}	Operating Junction and Storage Temperature	-55 to +175	$^\circ\text{C}$	



Electrical Characteristics ($T_c = 25^\circ\text{C}$ unless other wise specified)

Static Characteristics

Symbol	Parameter	Test conditions	Value			Unit
			Min.	Typ.	Max.	
$V_{(BR)DSS}$	Drain-Source Breakdown Voltage	$I_D=1\text{ mA}, V_{GS}=0\text{V}$	650			V
I_{DSS}	Zero Gate Voltage Drain Current	$V_{DS}=650\text{V}, V_{GS}=0\text{V}$		1	15	μA
I_{GSS}	Gate-Source Leakage Current	$V_{DS}=0\text{V}, V_{GS}=18\text{V}$			50	μA
$V_{GS(th)}$	Gate Threshold Voltage	$V_{DS}=V_{GS}, I_D=1\text{mA}$ $T_j=25^\circ\text{C}$ $T_j=175^\circ\text{C}$		3.5 2.8	4	V
$R_{DS(on)}$	Drain-Source On-State Resistance	$V_{GS}=18\text{V}, I_D=4.5\text{A}$ $T_j=25^\circ\text{C}$ $T_j=175^\circ\text{C}$		180 205	220	m Ω
	Drain-Source On-State Resistance	$V_{GS}=15\text{V}, I_D=4.5\text{A}$ $T_j=25^\circ\text{C}$ $T_j=175^\circ\text{C}$		260 295	300	nA
C_{iss}	Input Capacitance	$V_{DS}=400\text{V}, f=1\text{MHz},$ $V_{GS}=0\text{V}$		180		pF
C_{oss}	Output Capacitance			20		pF
C_{rss}	Reverse Transfer Capacitance			0.9		pF
Q_g	Total Gate Charge	$V_{DS}=400\text{V}, I_D=5\text{A},$ $R_G = 10\ \Omega$ $V_{GS} = 0/15\text{V}$		11.2		nC
Q_{gs}	Gate to Source Charge			2.3		nC
Q_{gd}	Gate to Drain Charge			1.1		nC
$t_{d(on)}$	Turn-On Delay Time	$V_{DD}=400\text{V}, I_D=5\text{ A},$ $V_{GS}=-5/18\text{ V},$ $R_G=10\ \Omega ,$		5		ns
t_r	Rise Time			17		ns
$t_{d(off)}$	Turn-Off Delay Time			8		ns
t_f	Fall Time			10		ns
E_{on}	Turn-On Energy			25		μJ
E_{off}	Turn-Off Energy			10		μJ



Reverse Diode Characteristics

Symbol	Parameter	Test conditions	Value			Unit
			Min.	Typ.	Max.	
V_{SD}	Diode Forward Voltage	$V_{GS}=-4V, I_{SD}=2.5A$ $T_j=25^{\circ}C$ $T_j=175^{\circ}C$		4.0 3.6		V
I_S	Continuous Diode Forward Current	$T_c=25^{\circ}C$ $T_c=100^{\circ}C$		15 12		A
t_{rr}	Reverse Recovery Time	$I_{SD}=-5A$ $V_{GS}=-5V, I_{SD}=4.5A,$		50		ns
Q_{rr}	Reverse Recovery Charge	$V_R=400V,$ $di/dt=1000A/\mu s$		38		nC
I_{rrm}	Peak Reverse Recovery Current			2.4		A

Thermal Characteristics

Symbol	Parameter	Value			Unit
		Min.	Typ.	Max.	
$R_{th(j-c)}$	Thermal Resistance from Junction to Case		2.88		$^{\circ}C/W$
$R_{th(j-a)}$	Thermal Resistance from Junction to Ambient		40		$^{\circ}C/W$



Typical Performance

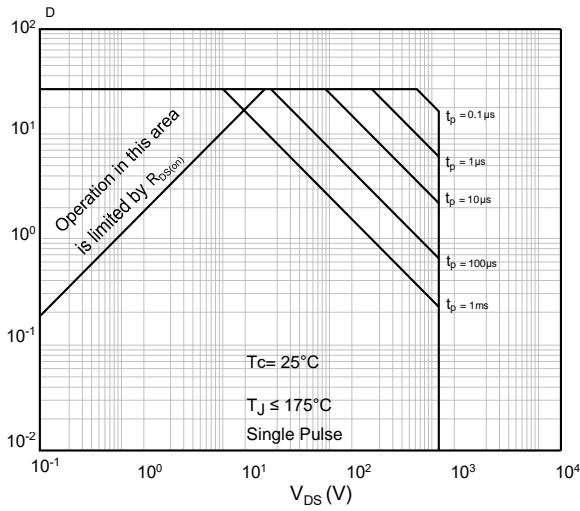

Figure 1. Safe Operating Area

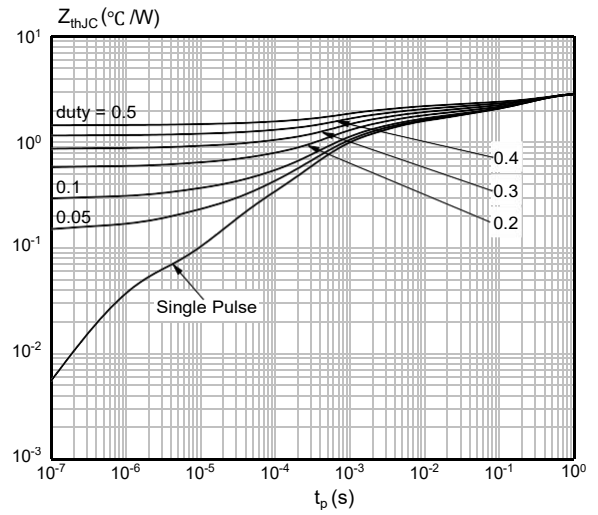

Figure 2. Maximum Transient Thermal Impedance

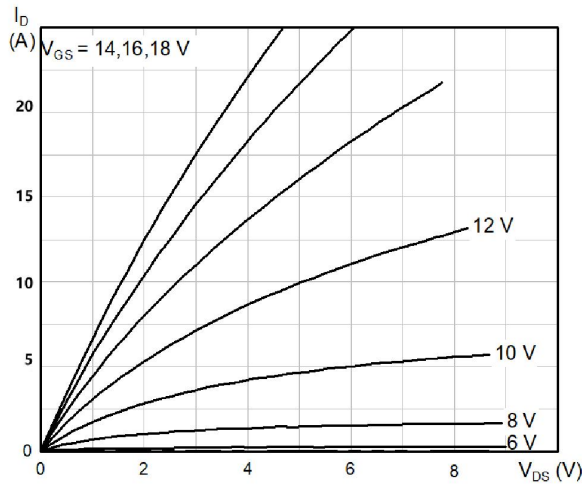

Figure 3. Typical Output Characteristics, $T_J = 25^\circ\text{C}$

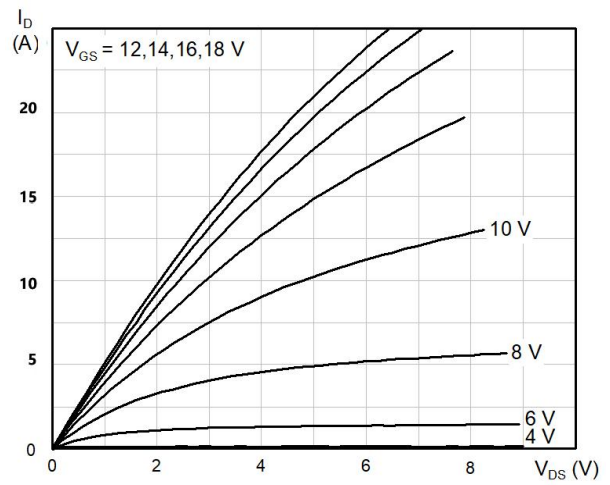

Figure 4. Typical Output Characteristics, $T_J = 175^\circ\text{C}$

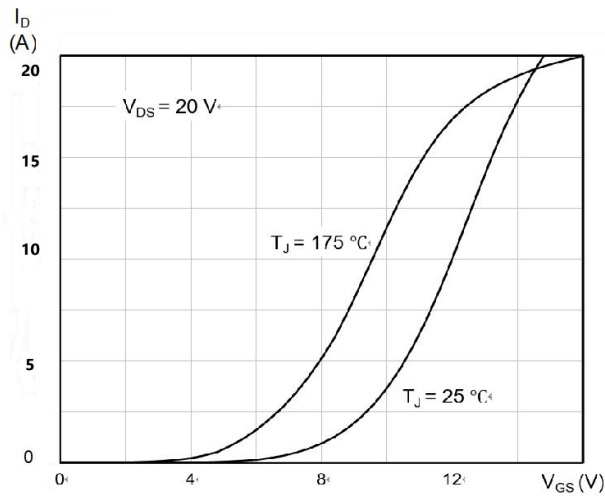

Figure 5. Typical Transfer Characteristics

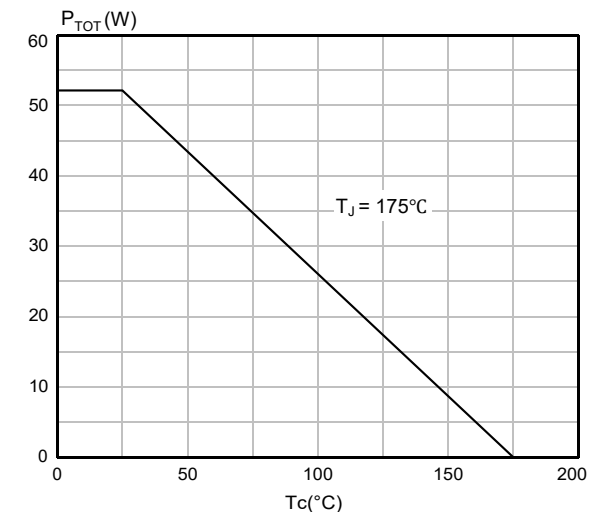

Figure 6. Total Power Dissipation

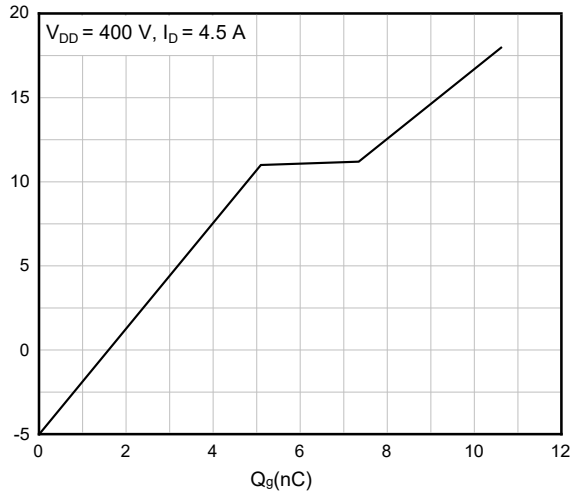

Figure 7. Typical Gate Charge Characteristics

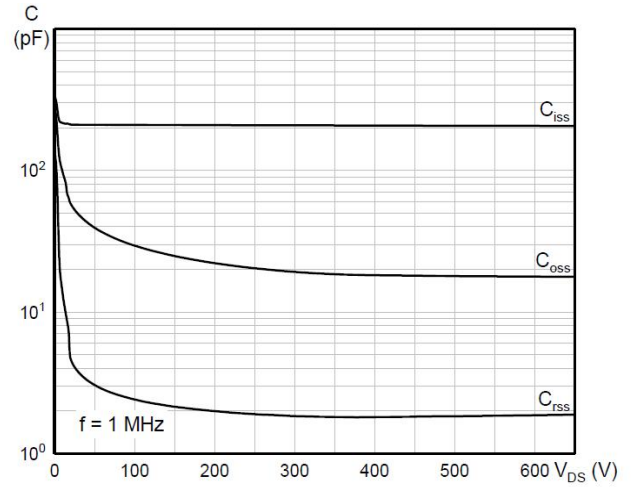

Figure 8. Typical Capacitance Characteristics

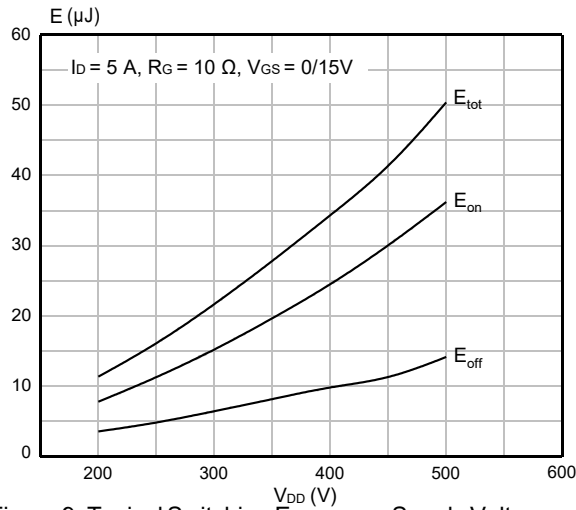

Figure 9. Typical Switching Energy vs. Supply Voltage

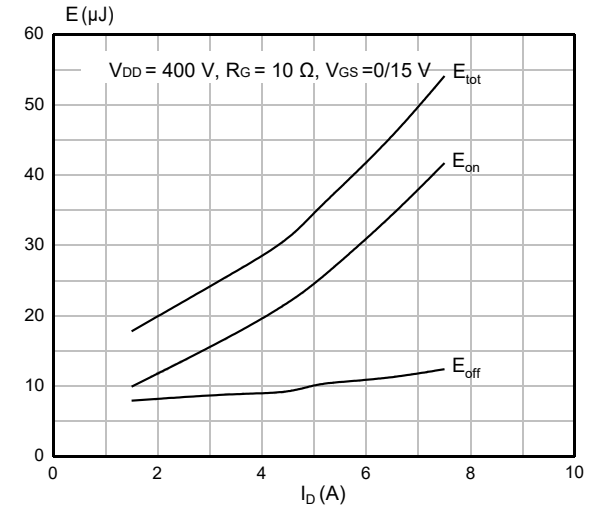

Figure 10. Typical Switching Energy vs. Drain Current

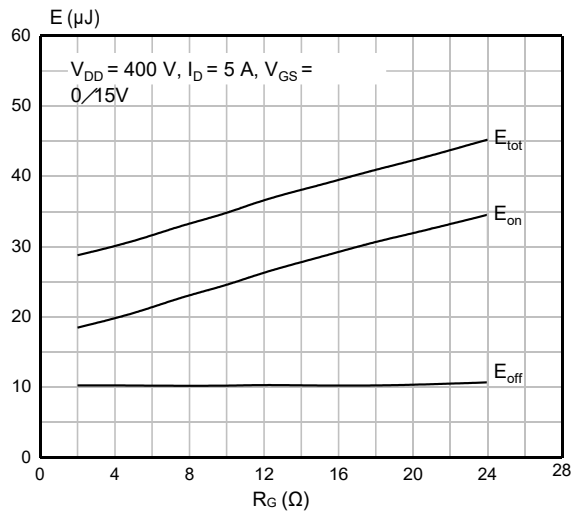

Figure 11. Switching Energy vs. Gate Resistance

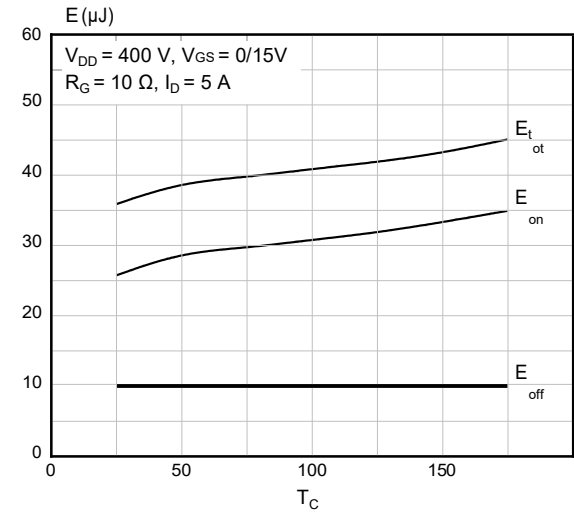

Figure 12. Typical Switching Energy vs. Temperature

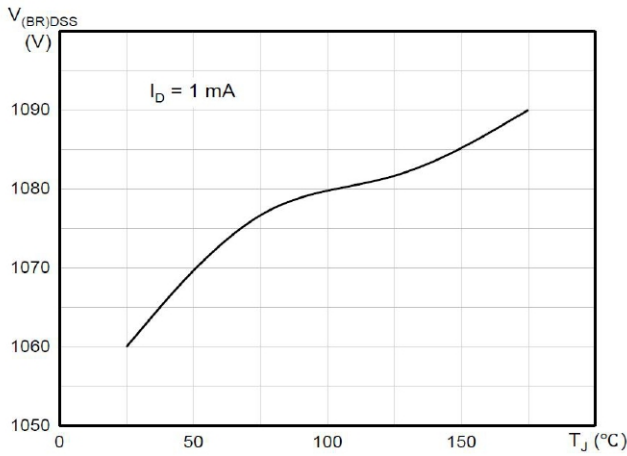

Figure 13. Breakdown Voltage vs. Temperature

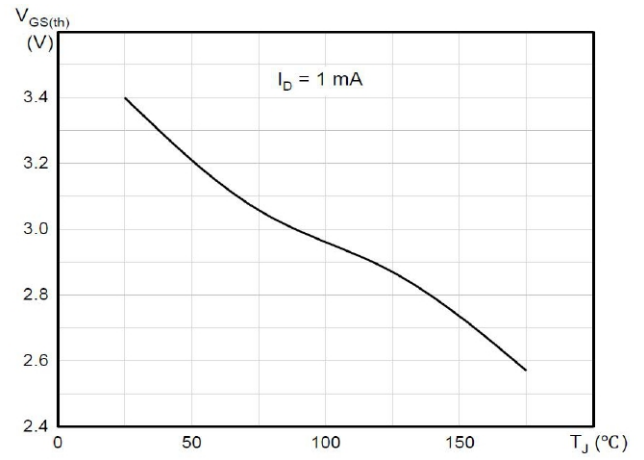

Figure 14. Gate Threshold vs. Temperature

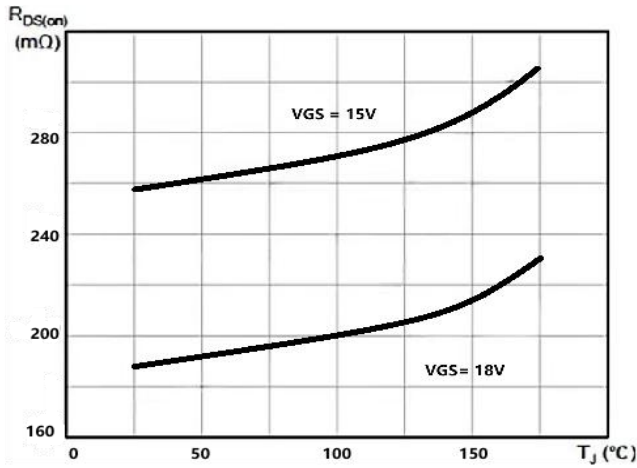

Figure 15. On-Resistance vs. Temperature

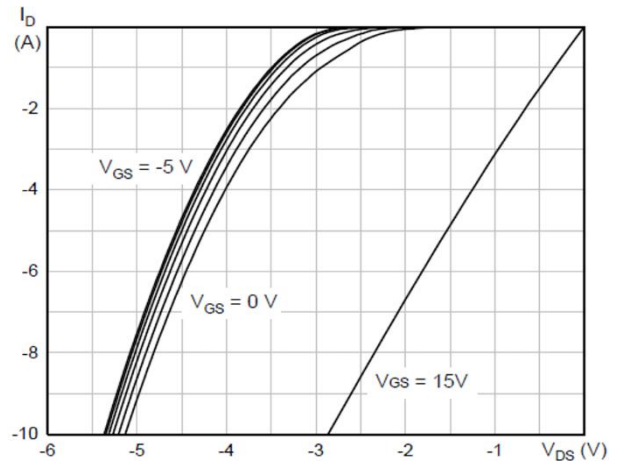

Figure 16. Body Diode Characteristics, T_J = 25°C

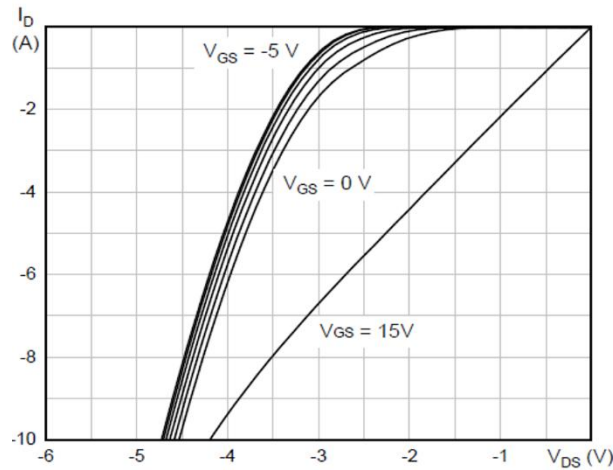
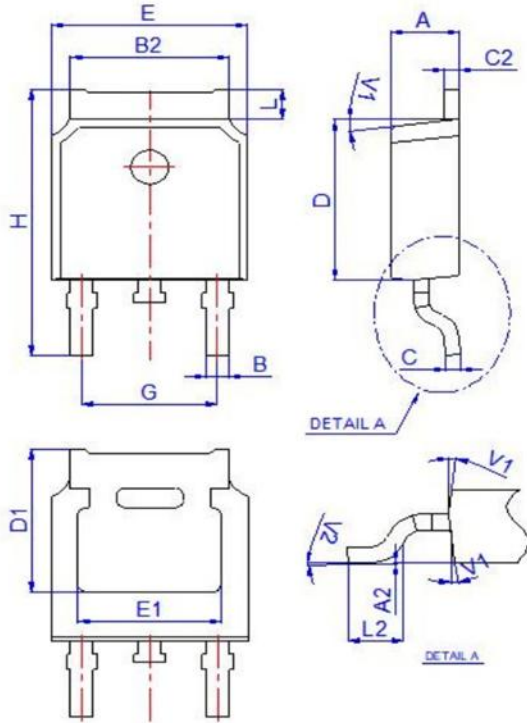

Figure 17. Body Diode Characteristics, T_J = 175°C



Package Dimensions

Package TO-252-2L



Ref.	Dimensions					
	Millimeters			Inches		
	Min.	Typ.	Max.	Min.	Typ.	Max.
A	2.10		2.50	0.083		0.098
A2	0		0.10	0		0.004
B	0.66		0.86	0.026		0.034
B2	5.18		5.48	0.202		0.216
C	0.40		0.60	0.016		0.024
C2	0.44		0.58	0.017		0.023
D	5.90		6.30	0.232		0.248
D1	5.30REF			0.209REF		
E	6.40		6.80	0.252		0.268
E1	4.63			0.182		
G	4.47		4.67	0.176		0.184
H	9.50		10.70	0.374		0.421
L	1.09		1.21	0.043		0.048
L2	1.35		1.65	0.053		0.065
V1		7°			7°	
V2	0°		6°	0°		6°



Attention

- Any and all HUA XUAN YANG ELECTRONICS products described or contained herein do not have specifications that can handle applications that require extremely high levels of reliability, such as life-support systems, aircraft's control systems, or other applications whose failure can be reasonably expected to result in serious physical and/or material damage. Consult with your HUA XUAN YANG ELECTRONICS representative nearest you before using any HUA XUAN YANG ELECTRONICS products described or contained herein in such applications.

- HUA XUAN YANG ELECTRONICS assumes no responsibility for equipment failures that result from using products at values that exceed, even momentarily, rated values (such as maximum ratings, operating condition ranges, or other parameters) listed in products specifications of any and all HUA XUAN YANG ELECTRONICS products described or contained herein.

- Specifications of any and all HUA XUAN YANG ELECTRONICS products described or contained herein stipulate the performance, characteristics, and functions of the described products in the independent state, and are not guarantees of the performance, characteristics, and functions of the described products as mounted in the customer's products or equipment. To verify symptoms and states that cannot be evaluated in an independent device, the customer should always evaluate and test devices mounted in the customer's products or equipment.

- HUA XUAN YANG ELECTRONICS CO.,LTD. strives to supply high-quality high-reliability products. However, any and all semiconductor products fail with some probability. It is possible that these probabilistic failures could give rise to accidents or events that could endanger human lives, that could give rise to smoke or fire, or that could cause damage to other property. When designing equipment, adopt safety measures so that these kinds of accidents or events cannot occur. Such measures include but are not limited to protective circuits and error prevention circuits for safe design, redundant design, and structural design.

- In the event that any or all HUA XUAN YANG ELECTRONICS products(including technical data, services) described or contained herein are controlled under any of applicable local export control laws and regulations, such products must not be exported without obtaining the export license from the authorities concerned in accordance with the above law.

- No part of this publication may be reproduced or transmitted in any form or by any means, electronic or mechanical, including photocopying and recording, or any information storage or retrieval system, or otherwise, without the prior written permission of HUA XUAN YANG ELECTRONICS CO.,LTD.

- Information (including circuit diagrams and circuit parameters) herein is for example only ; it is not guaranteed for volume production. HUA XUAN YANG ELECTRONICS believes information herein is accurate and reliable, but no guarantees are made or implied regarding its use or any infringements of intellectual property rights or other rights of third parties.

- Any and all information described or contained herein are subject to change without notice due to product/technology improvement, etc. When designing equipment, refer to the "Delivery Specification" for the HUA XUAN YANG ELECTRONICS product that you intend to use.