



深圳东裕光大电子有限公司
广州市东裕光电科技有限公司

产品规格书 SPECIFICATION

客户名称 CUSTOMER	
产品名称 PRODUCTION	贴片反射式光电开关 SMD Reflective Sensor
产品型号 MODEL	DY-ITR9909-W2-1KB
版本号 VERSION NO	A2.0

地址(Add): 深圳市宝安区沙井街道后亭沙松路全至科技创新园叁号楼 5T

厂址(Add): 广东省广州市番禺区石基镇海涌路3号10号厂房2楼

电话(Tel): 0755-88366557 020-39294688

传真(Fax): 020-39966833

网址(Net): www.tonyuled.cn www.tonyuled.com



客户确认 CUSTOMER CONFIRMATION	审核 CHECKED BY	编制 PREPARED BY
	邓晓军	区家俊

产品描述 Descriptions

- 贴片反射式光电开关
(An reflective sensor)

产品特性 Features

- 可靠性高 (High reliability)
- 响应时间快 (Fast response time)
- 解析度高 (High analytic)
- 敏感度高 (High sensitivity)
- 截止波长 940nm (Cut-off visible wavelength $\lambda_P=940\text{nm}$)
- 无铅 (Pb free)
- 符合 RoHS 要求 (This product itself will remain within RoHS compliant version)

产品应用 Applications

- 鼠标 (Mouse Copier)
- 码盘 (Switchc Scanner)
- 非接触式开关 (Non-contact Switching)
- 智能家电 (Smart Appliances)

包装方式 Packing Quantity Specification

- 编带 600 个/卷 (600PCS/rolls)

一、外形图 Outline dimensions:

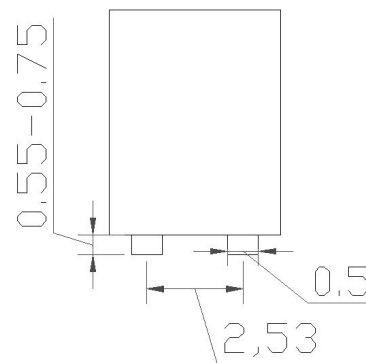
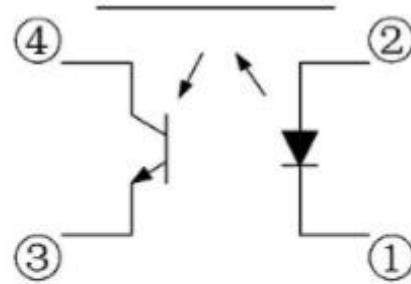
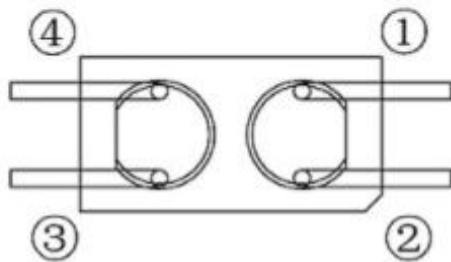
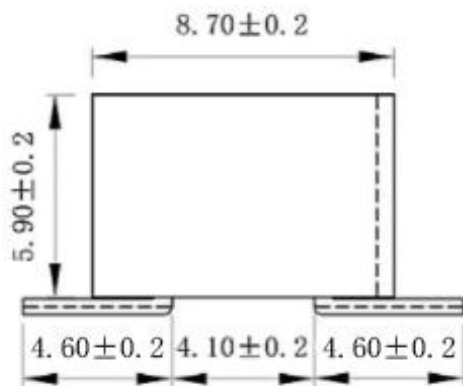
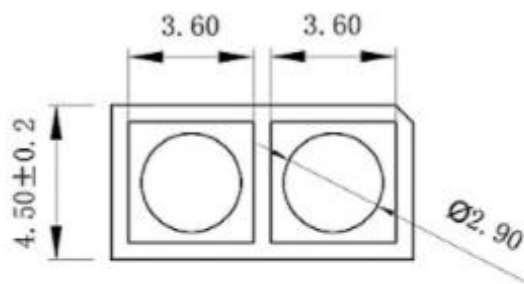

- ① Cathode
- ② Anode
- ③ Emitter
- ④ Collector

注(Notes): 1、所有尺寸均以毫米为单位(All dimensions are in millimeters)。
2、尺寸公差值为±0.25mm(Tolerances unless dimensions ±0.25mm)。

二、光电参数 Electro-Optical Characteristics:

(环境温度 Ambient temperature: 25°C, 环境湿度 Humidity: RH60%)

项目 Item	符号 Symbol	测试条件 Test condition	最小值 Min.	典型值 Type	最大值 Max	单位 Unit	
输入 Input	正向电压 Forward voltage	IF=20mA	-	1.2	1.5	V	
		IF=100mA, tp=100μs, tp/T=0.01		1.4	1.85		
		IF=1A, tp=100μs, tp/T=0.01		2.6	4.0		
	反向电流 Reverse current	IR	VR=5V	-	-	10	μA
峰值波长 Peak wavelength	λp	IF=20mA	-	940	-	nm	
输出 Output	暗电流 Dark Current	ICEO	VCE=20V Ee=0mW/cm2	-	-	100	nA
	C-E 饱和电压 C-E Saturation Voltage	VCE(sat)	IC=2mA, Ee=1mW/cm2	-	-	0.4	V
传输特性 Transfer Characteristics	集电极电流(*) Collector Current(*)	IC(ON)	VCE=5V, IF=20mA	2.19	-	-	mA
	上升时间 Rise Time	TR	VCE=5V, IC=1mA RL=1KΩ	-	15	-	μs
	下降时间 Fall Time	TF		-	15	-	μs

注(Notes): *正向电压公差范围(Forward voltage tolerance): ±0.1v

*集电极电流公差范围(Collector current tolerance): ±10%

*波长公差范围(wavelength tolerance): ±1.0nm

*IC(on)的测试条件——距离反光面 6mm

(IC(on) at the testing condition——with reflector in 6mm away.)

三、典型光电特性曲线图 Typical photoelectricity characteristic curve chart:

IR 光电特性图 Typical Characteristics For IR

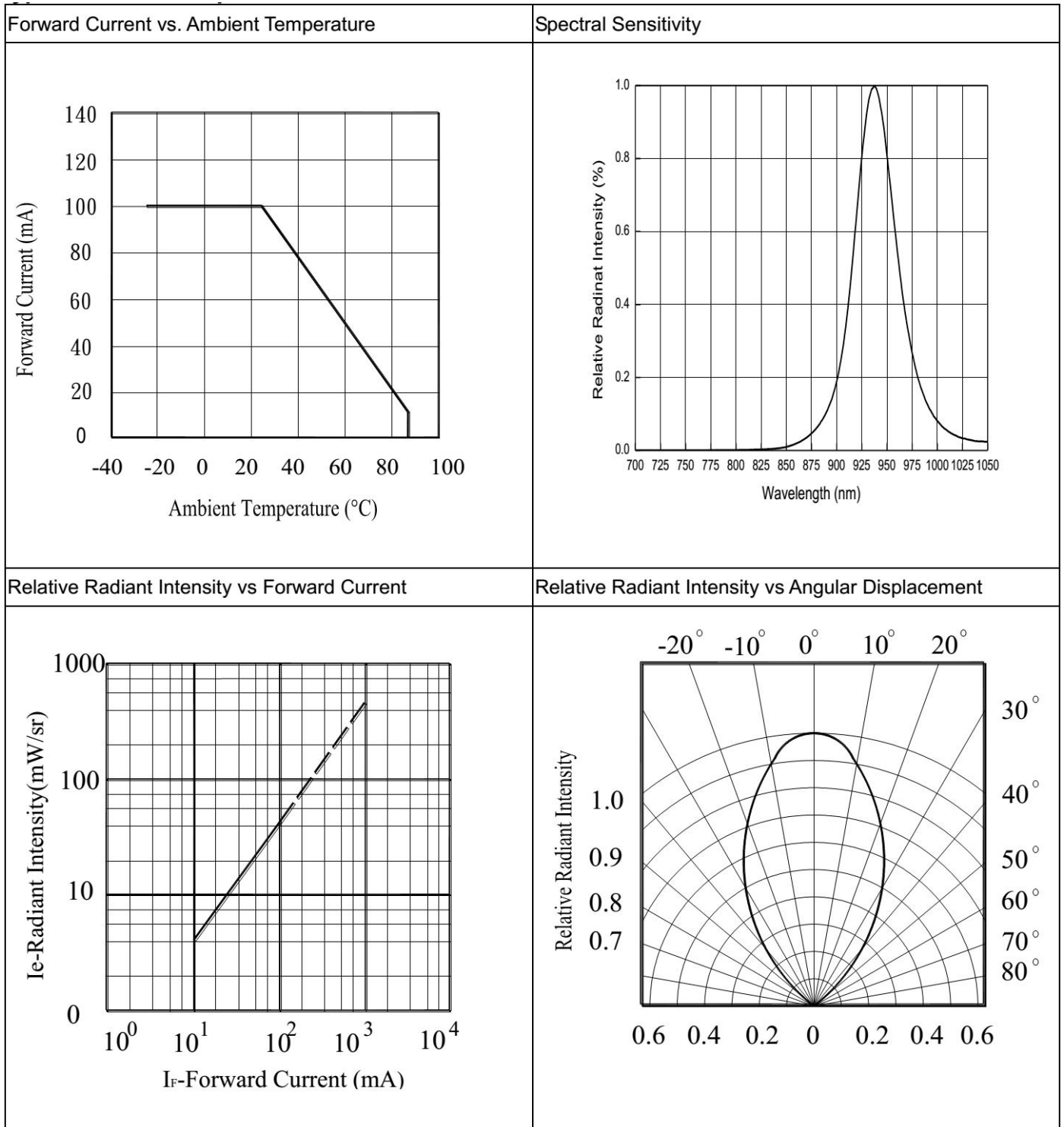

PT 光电特性图 Typical Characteristics For PT

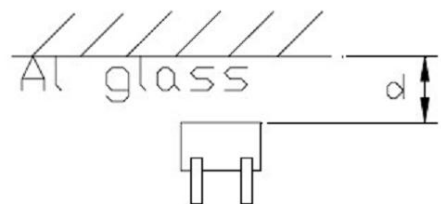
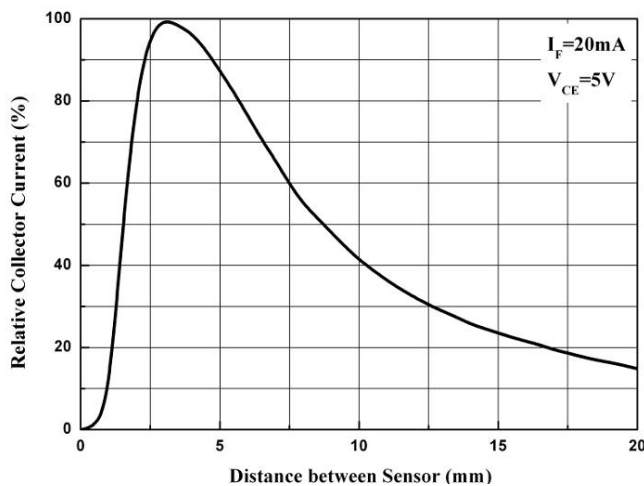
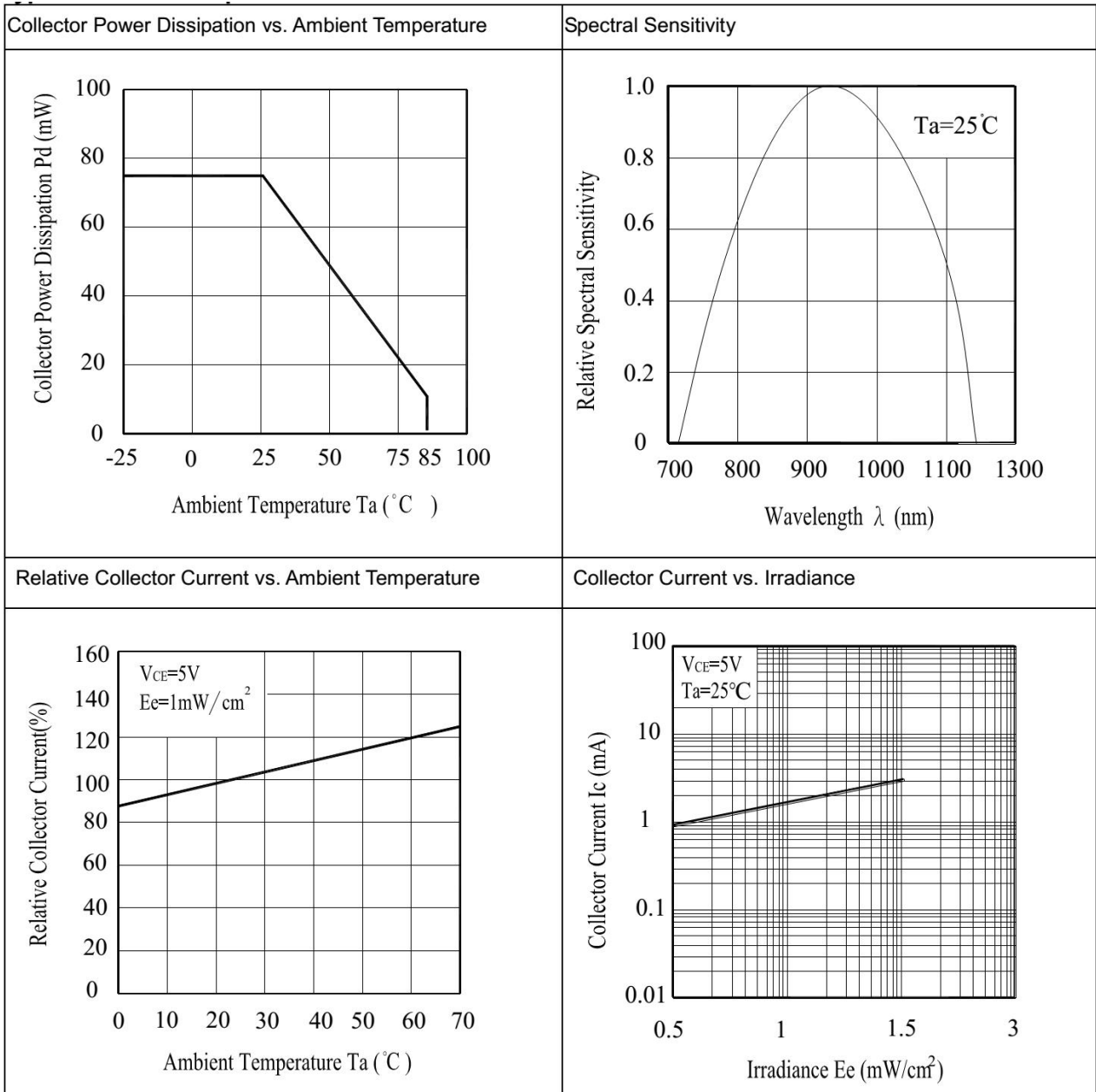

四、极限参数 Absolute Maximum Rating:

(环境温度 Ambient temperature: 25°C, 环境湿度 Humidity: RH60%)

项目 Item	符号 Symbol	数值 Value	单位 Unit	备注 Remark	
输入 Input	常温下功耗 Power Dissipation	Pd	75	mW	at(or below) 25°C Free Air Temperature
	反向耐压 Reverse Voltage	V _R	5	V	---
	正向电流 Forward Current	I _F	50	mA	---
	正向峰值电流 Peck forward current	I _{FP}	1	A	Pulse width $\leq 100\mu\text{s}$, Duty cycle=1% tw=100 μsec , T=10 msec
输出 Output	集电极功耗 Collector Power Dissipation	P _c	75	mW	---
	集电极电流 Collector Current	I _c	50	mA	---
	C-E 电压 Collector-Emitter Voltage	BV _{CEO}	30	V	
	E-C 电压 Emitter-Collector Voltage	BV _{ECO}	5	V	
使用温度 Operating Temperature	T _{opr}	-25~+85	°C		
储存温度 Storage Temperature	T _{stg}	-45~+85	°C		
焊接温度 Soldering temperature	T _{sol}	255	°C	回流焊: 255°C \leq 10 秒 Reflow soldering : 255 °C for 10 sec.	

五、包装圆盘尺寸 Package disk dimensions

包装数量: 600 pcs/卷 Packing quantity: 600 PCS/rolls

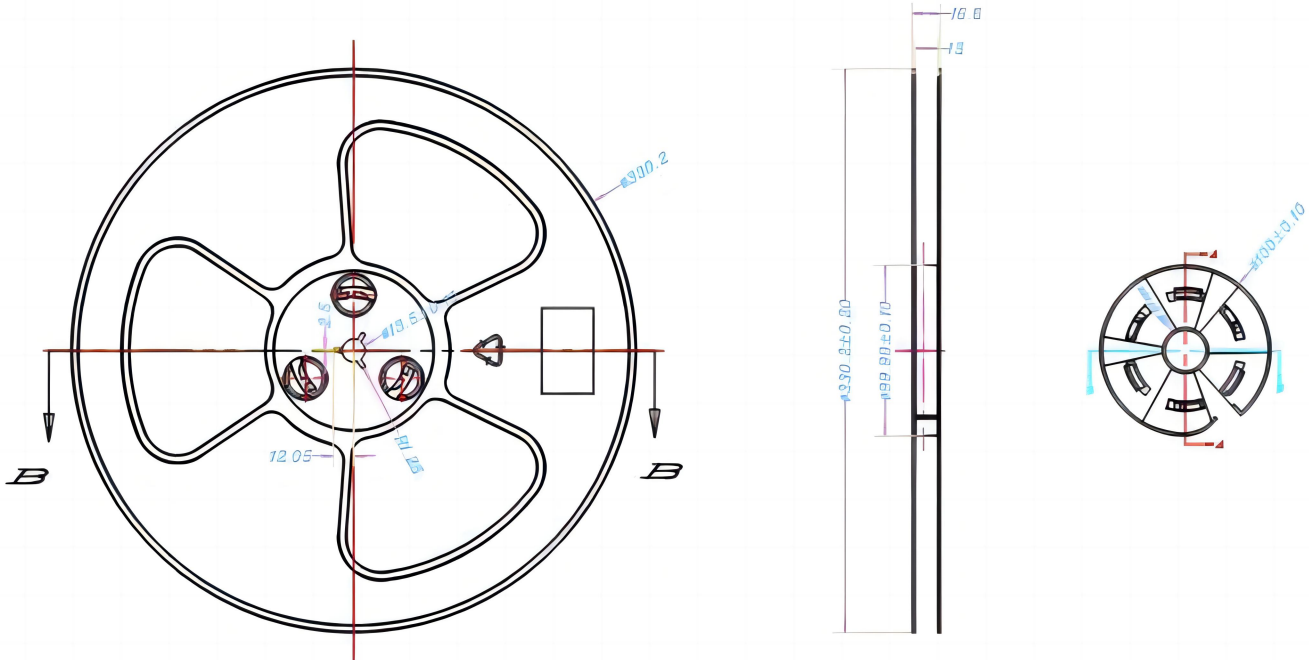

注: 所有尺寸均为毫米, 除非另有说明, 公差为 ± 0.1 。

Notes: All dimensions are in mm, tolerance is ± 0.1 unless otherwise noted.

标签及标识/ Label Explanation:

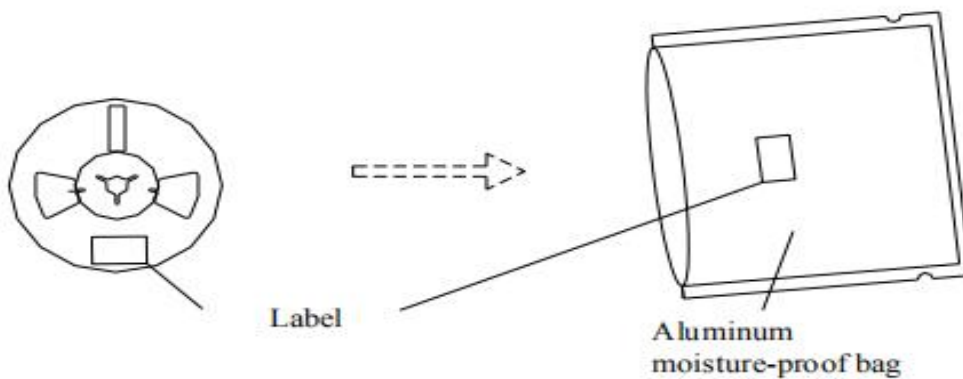

六、注意事项 Note

封装发光二极管的材料是硅性质，因此发光二极管的表面柔软而有弹性。虽然有机硅的特点能降低热应力，但是更容易受到机械外力的破坏，在表面上施加压力将会影响发光二极管的可靠性。在这样的情况下，装配使用有机硅封装的发光二极管产品时必须遵守相应的处理措施，避免任何的应力施加给发光二极管的任何部分，所以在使用时请采用气动吸咀。否则会导致发光二极管损坏和可靠性降低影响其寿命。

Packaged LED material is silicone nature, therefore, LED has is a soft and flexible surface. Although characteristics of silicone is to reduce thermal stress, but it is more susceptible to mechanical damage to the external forces applied on the surface. Pressure affects the reliability of light emitting diodes. In such circumstances, the assembly of organic silicon encapsulated LED products must comply with the appropriate measures to deal with. Avoid any pressure applied to any part of the LED and use pneumatic nozzle. Otherwise it may lead to reduction in reliability, and impact of its life to the LED.

温度控制 The temperature control

产品灯脚温度需控制在 85°C 以下

Product light foot temperature under 85 °C which shall be controlled

回流焊说明 Reflow soldering instructions

推荐使用以下回流焊接温度图进行

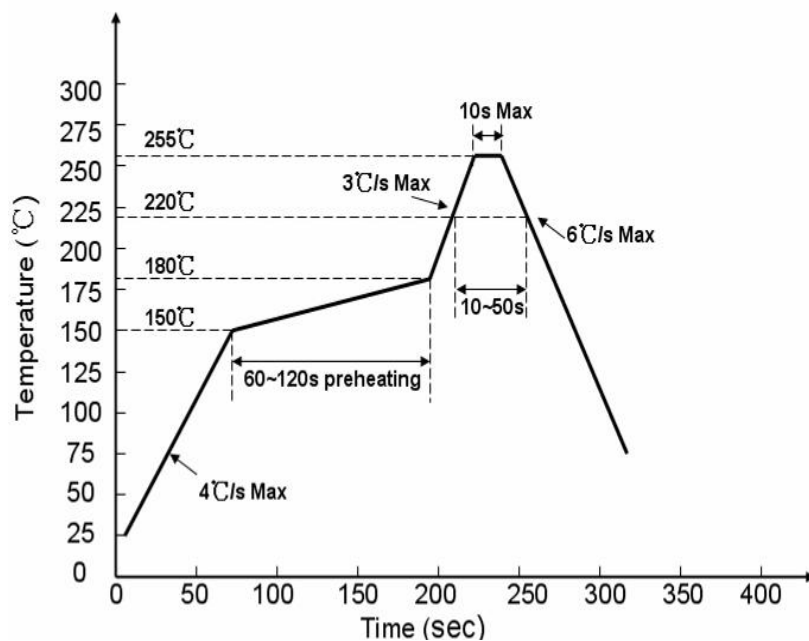

只能焊接 1 次。

1 Time soldering only.

烙铁焊接 Soldering

1、当手动焊接时，建议采用 20W 的防静电烙铁，焊头的温度必须控制在 300°C 以下/3 秒，焊接次数为 1 次。

When manual soldering iron is used, it is recommended to use 20W anti-electro static soldering iron, soldering temperature must be kept below 300 °C/3 seconds, 1 Time soldering only

2、不可在同一单元板上焊接不同 BIN 的材料，否则会导致 LED 色差。

Do not mix different BIN materials on the same board, otherwise it will cause LED color Variation.

防静电措施 ESD countermeasure

对于整个工序（生产、测试、包装等）所有与 LED 直接接触的员工都要做好防止和消除静电措施，主要有：

All employees have direct contact with LED for all processes (production, testing, packaging, etc.) must perform all preventive and eliminating static electricity measures.



1、车间铺设防静电地板并做好接地，工作台采用防静电工作台，带电产品接触低阻值的金属表面时，由于急放电引发产品故障的可能性是很高的，故要求工作台及与产品相接触之处使用表面电阻为 106-109Ω 的桌垫。

Workshop floors to use of the anti-static flooring and grounding, anti-static work bench, when charged material is in contact with low resistance metal surface, due to acute discharge, possibility of product failure is very high, so the requirements of the bench and any contact with the products should have surface resistance of 106-109Ω table mats.

2、生产机台如：锡炉、回流焊、SMT 设备、电烙铁，以及检测设备均需接地良好，接地交流阻抗小于 1.0Ω。在容易产生静电的环境与设备上，还必须安装离子风扇、作业过程中，操作员穿防静电服、带防静电手环、手套等，取放时尽可能接触产品的绝缘部分。

Production machines such as: tin furnace, reflow soldering, SMT equipment, electric soldering iron, and testing equipment need to be grounded, grounded AC impedance less than 1.0 ohm. Prone to static electricity environment and equipment must be installed ion fan. During working process, operators to wear anti-static clothing, wrist strap, gloves, and etc., When handling, hold the insulated part of the product as much as possible.

3、盛装 LED 使用防静电元件盒，包装则采用防静电材料。

For packaging of LED, anti-static component boxes, packaging materials should be use.

4、请保持环境湿度在 60%RH 以下，以免空气过于干燥产生静电。

Keep ambient humidity below 60% RH to avoid air being too dry to generate static electricity.

5、静电接地需与电源零线、防雷地线分开，接地措施应完全防止静电产生，必须用粗的铜线引入泥土内，在铜线末端系上大铁块，埋入地表 1 米以下，各接地线均需与主线连接在一起。

Grounding should be connected to the neutral input line. It should be separated from the lightning grounding. Grounding should be done with anti-static. Heavy gauge copper cable should be connected to a large piece of metal and buried at least 1 meter deep into the ground. All ground cables must be connected together with the main cable

修复 Repair

当修复发光二极管时，应事先确认发光二极管是否会被破坏，修复过程中应避免接触胶体表面，烙铁不能碰触到 LED 灯珠，双焊头烙铁应使用如下图的方式作业。

When repairing light-emitting diodes, it is advised to confirm the light emitting diode will be damaged, the repair process should avoid contact with the colloid surface, The head of iron can not touch the LEDs, use of soldering iron should be according to following diagram.

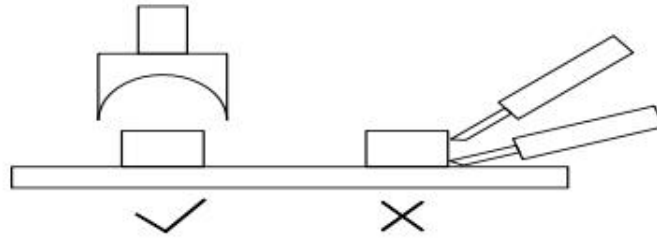

清洗 Clean

在焊接后推荐使用纯酒精清洗，清洗擦拭或浸渍不要超过 1 分钟。使用其它类似溶剂清洗前，请确保溶剂不会对发光二极管封装造成损伤。

Recommend the use of pure alcohol to clean, wash and wipe or dipping no more than 1 minutes after soldering. When different solvents are used for cleaning, make sure that solvents do not damage the light emitting diode packaging

灌封 Potting

1、使用硅酮胶（玻璃胶）灌封时推荐采用中性、醇型类灌封胶。

The use of silicone rubber (plastic glass) for potting, it is recommended the use of alcoholic encapsulating Material.

2、灌封胶若使用脱肟型中性灌封胶，请确保灌封胶固化过程中的通风良好，在未完成固化过程中不可进行密封组装发光二极管元件。这样会造成镀银层氧化及发光颜色变淡。

When deoximation neutral potting material is used, make sure that the potting curing process in well-ventilated. Do not perform sealing assembly of Light Emitting Diodes before potting is completely cured and setting process is completed. This will result in the silver layer oxidation and luminous color fades, light degradation and even dead LED.

3、禁止使用醋酸型（酸性）硅酮胶进行灌封。

Prohibit the use of acetic acid type (acidic) silicone rubber potting materials.

4、使用正常灌封胶时建议进行少量灌封试验，常温点亮测试 168H 确认无异常后再批量作业。

It is recommended that small quantity samples are made for potting test, Room temperature light test of 168H confirming no abnormality before mass products.

5、更改任何一种灌封材料时，请先作试样确认是否对我司产品造成侵蚀反应。将灌封材料取 5-10g 和发光二极管 10-20pcs 于 100ml 的器皿内密封放置 168H 后确认产品是否有异常。

When there is change in potting material, please make samples to confirm whether there is erosion reaction. Take 5-10 grams of potting material and 10-20 pcs in a 100ml sealed containers for 168H confirm whether there is abnormality.

使用操作示意图 Operating diagram

1、使用镊子或合适的工具，沿侧表面夹取元件。

Use forceps or other appropriate tools grip along the side surface of component.

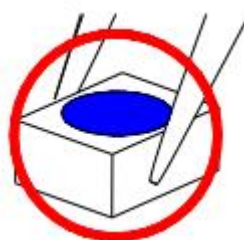

2、不要接触有机硅的表面，它可能会破坏发光二极管的内部电路。

Do not touch the silicone surface. It may damage the internal circuitry of the LED.



3、不要将焊接好的发光二极管堆叠放置，会导致发光二极管划伤及胶体受损造成死灯。

Do not stack soldered LED, it may cause scratching of LED and silicone damage leading to dead LED.

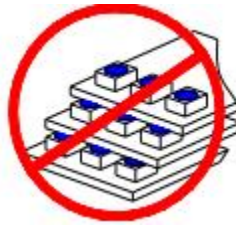

4、不可接触和使用天那水、三氯乙烯、丙酮、硫化物、钠离子及酸、碱、盐等物质，这样会造成镀银层氧化及荧光粉硫化。致使发光二极管发光颜色变淡、亮度变暗等现象发生。

Do not make contact with thinner, Trichloroethylene, acetone, sulfide, sodium ion and acid, alkali, Salt and other substances. These materials will cause oxidation of silver plating and vulcanization of phosphor leading to color fading and reduction of brightness conditions.

储存 Storage

1、建议未拆封前储存条件：小于 30°C/60%RH 下，保存期限为一年。

Recommended storage conditions before opening packaging: <30 °C / <60% RH, retention period of one year.

2、拆封后在室温<30°C，湿度 60%RH 以下，建议在 4H 内完成回流焊作业，12H 内完成封装作业。因发光二极管吸湿后回流焊高温会导致硅胶与 PPA 分层，元器件失效。对于未使用之产品，请采取除湿处理（卷轴产品 75°C±5°C/12H，散装产品 10°C±5°C/1H，在烤箱内作自然冷却 1H）后再进行使用。

After opening of packaging: Room temperature <30 ° C, humidity < 60% RH. It is recommended to complete the reflow soldering operations in 4Hours. Complete LED packaging operations within 12 hours. If LED absorbed moisture prior to high temperature reflow soldering process, it will cause silicone and PPA to separate leading to component failures. Unused products, perform dehumidification procedure (reel products 75 ° C ± 5 ° C / 12H, bulk products, 110 ° C ± 5 ° C / 1H, natural cooling 1H inside oven) before reuse.