



YUFENGCIYE

0010525

Jingweitang Industrial Zone,
Dalingshan Town, Dongguan City

Sales: Ms. Wang

Mobile number : +86 189-4861-7861

Web: [Http://www.yufengciye.com](http://www.yufengciye.com)

E-mail: yufengciye@126.com

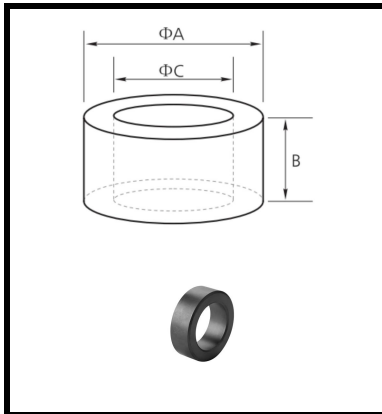

Product Category	Core Marking			Coating Color
	Lot Number	Part Number	Inductance Grade	
Ferrite Core	2601	0010525	N/A	WHITE

Dimensions	Uncoated		Coated Limits			Packaging Box Qty=120 pcs
	(mm)	(in)	(mm)	(in)		
OD (A)	18.05	0.711	18.59	0.733	MAX	
ID (C)	10.05	0.396	9.55	0.376	MIN	
HT (B)	12.05	0.475	12.77	0.503	MAX	

Electrical Characteristics			Physical Characteristics						
IMPEDANCE RESULT (Testing Condition:0.65x0.5TSx120mm)			Initial Permeability	Saturation Magnetic Flux Density	Remanence	Coercivity	Density	Material	Weight (g)
@1Mhz	45Ω	50%							

The Limit of Breakage					Temperature Rating	
Winding Length Per Turn			Wound Coil Dimensions (mm)		Curie Temp: >160°C	
Winding Factor	(mm)	Winding Factor	(mm)	40% Winding Factor	OD	-
					HT	-
				Completely Full Window	Max OD	-
					Max HT	-
				Surface Area (mm ²)		Notes:
				Unwound Core	-	
				40% Winding Factor	-	

