

DESCRIPTION

The EV2236-J-00A Evaluation Board is designed to demonstrate the capabilities of MPS' MP2236, a fully-integrated high-frequency, synchronous rectified, step-down, switch-mode converter with internal power MOSFETs. It offers a very compact solution to achieve a 6A continuous output current over a wide input range, with excellent load and line regulation.

Constant On-Time control operation provides very fast transient response and easy loop design as well as very tight output regulation.

Full protection features include SCP, OCP, and thermal shutdown.

The MP2236 requires a minimal number of readily-available, standard, external components and is available in a space-saving 8 pin-TSOT23 package.

ELECTRICAL SPECIFICATION ⁽¹⁾

Parameter	Symbol	Value	Units
Input Voltage	V _{IN}	12	V
Output Voltage	V _{OUT}	1	V
Output Current	I _{OUT}	6	A

Notes:

1) For different Input/output voltage specs and different output capacitor/inductor may need change the application circuit parameters.

FEATURES

- Wide 3V-to-18V Operating Input Range
- 25mΩ/12mΩ Low-R_{DS(ON)} Internal Power MOSFETs
- 6A Continuous Output Current
- 600mV Reference Voltage
- 600kHz Switching Frequency
- Internal Soft-Start
- Over-Current Protection and Hiccup
- Thermal Shutdown
- Ton Extension
- Available in a 8-pin TSOT-23 package

APPLICATIONS

- Digital TV Power Supply
- Digital Set-Top Boxes
- Flat-Panel Television and Monitors
- Distributed Power Systems

All MPS parts are lead-free, halogen free, and adhere to the RoHS directive. For MPS green status, please visit MPS website under Quality Assurance.

"MPS" and "The Future of Analog IC Technology" are Registered Trademarks of Monolithic Power Systems, Inc.

EV2236-J-00A EVALUATION BOARD



(L x W) 63.5mm x 63.5mm

Board Number	MPS IC Number
EV2236-J-00A	MP2236GJ

Efficiency

V_{OUT}=1V L=1μH DCR=4.6mΩ

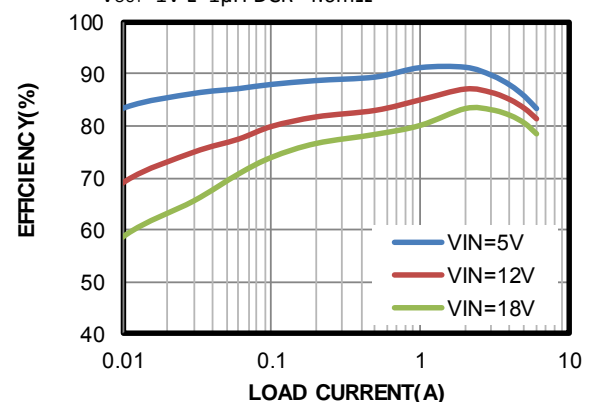

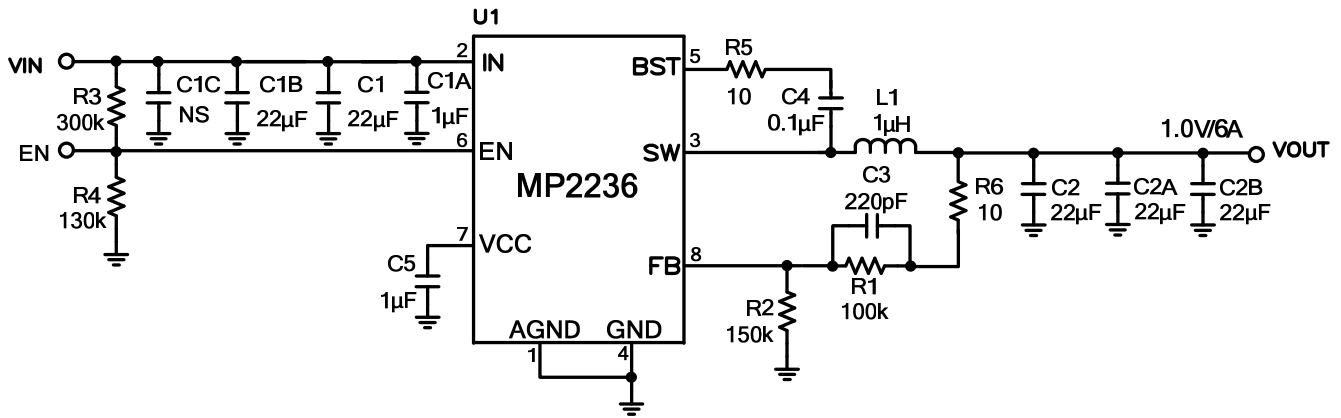
EVALUATION BOARD SCHEMATIC

EV2236-J-00A BILL OF MATERIALS

Qty	Ref	Value	Description	Package	Manufacturer	Part Number
2	C1, C1B	22µF	Ceramic Cap.,25V,X5R	1206	Murata	GRM31CR61E226KE15L
2	C1A, C5	1µF	Ceramic Cap.,25V,X7R	0603	Murata	GRM188R71E105KA12D
0	C1C	NS				
3	C2, C2A, C2B	22µF	Ceramic Cap.,10V,X7R	1206	Murata	GRM31CR71A226ME15L
1	C3	220pF	Ceramic Cap.,50V,X7R	0603	Murata	GRM188R71H221KA01D
1	C4	100nF	Ceramic Cap.,16V,X7R	0603	Murata	GRM188R71C104KA01D
1	R1	100k	Film Res,1%,0603,100K	0603	YAGEO	RC0603FR-07100KL
1	R2	150k	Film Res,1%,0603,150K	0603	YAGEO	RC0603FR-07150KL
1	R3	300k	Film Res,1%,0603,300K	0603	YAGEO	RC0603FR-07300KL
0	R4	130k	Film Res,1%,0603,130K	0603	YAGEO	RC0603FR-07130KL
2	R5, R6	10R	Film Res,1%,0603,10R	0603	YAGEO	RC0603FR-0710RL
1	L1	1µH	Inductor,RDC=4.6 mΩ,Isat=15A	SMD	Würth	744311100
1	U1	MP2236GJ	Step-down converter	TSOT23-8	MPS	MP2236GJ

EVB TEST RESULTS

$V_{IN} = 12V$, $V_{OUT} = 1V$, $L = 1\mu H$, $T_A = +25^\circ C$, unless otherwise noted.

Efficiency

$V_{OUT} = 1V$, $L = 1\mu H$, $DCR = 4.6m\Omega$

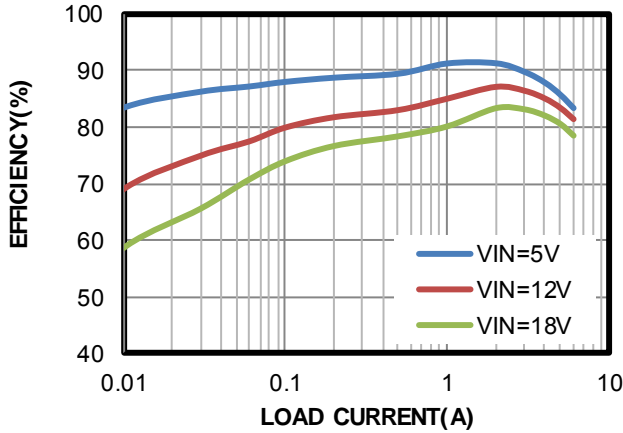

Case Temperature Rise vs. Load Current

$V_{OUT} = 3.3V$, 4 layers PCB, size is 63.5mmx63.5mm

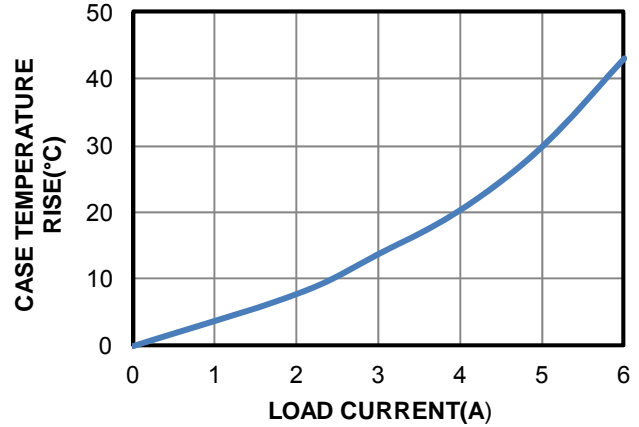

Load Regulation

$I_{OUT} = 0.01A$ to $6A$

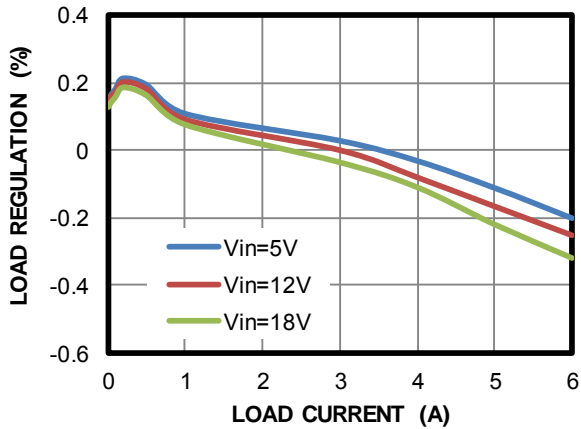

Line Regulation

$V_{IN} = 4V$ to $18V$

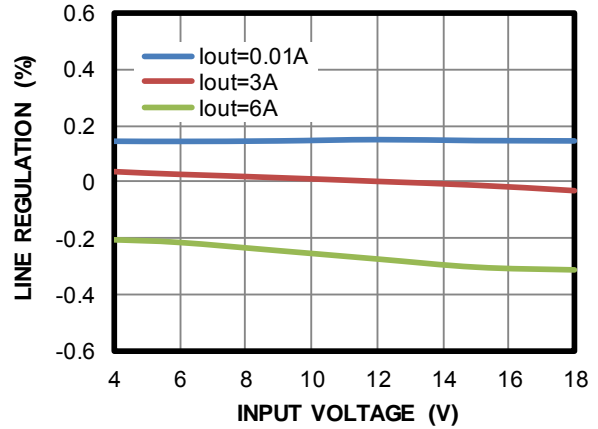

EVB TEST RESULTS *(continued)*

$V_{IN} = 12V$, $V_{OUT} = 1V$, $L = 1\mu H$, $T_A = +25^\circ C$, unless otherwise noted.

Start up through Input Voltage

$I_{OUT} = 0A$

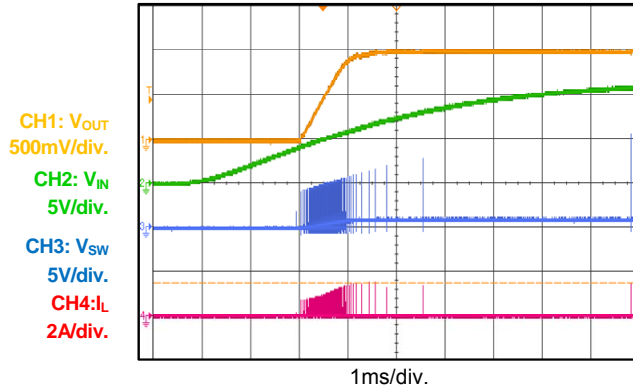

Shutdown through Input Voltage

$I_{OUT} = 0A$

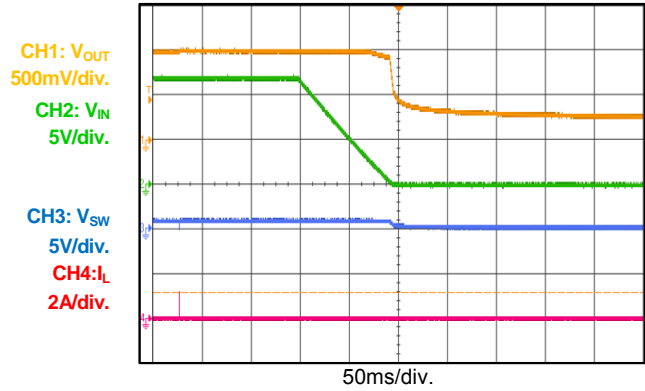

Start up through Input Voltage

$I_{OUT} = 6A$

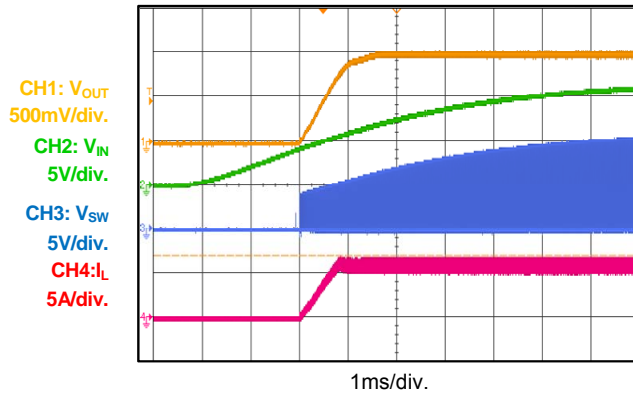

Shutdown through Input Voltage

$I_{OUT} = 6A$

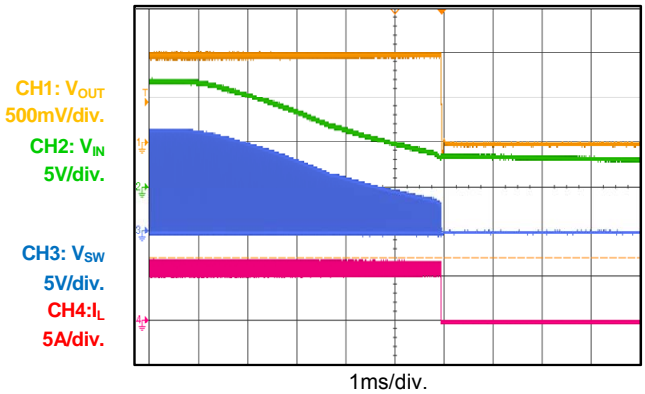

Start up through Enable

$I_{OUT} = 0A$

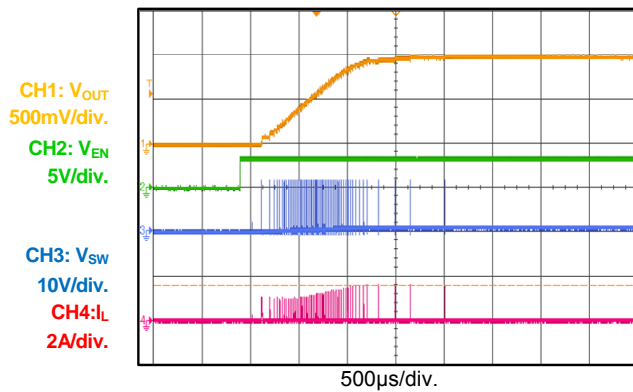

Shutdown through Enable

$I_{OUT} = 0A$

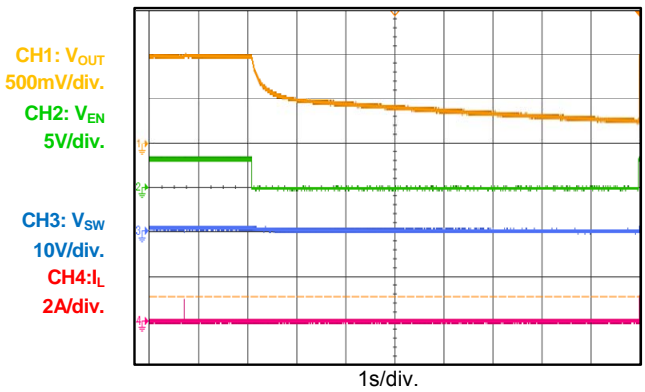

EVB TEST RESULTS *(continued)*

$V_{IN} = 12V$, $V_{OUT} = 1V$, $L = 1\mu H$, $T_A = +25^\circ C$, unless otherwise noted.

Start up through Enable

$I_{OUT} = 6A$

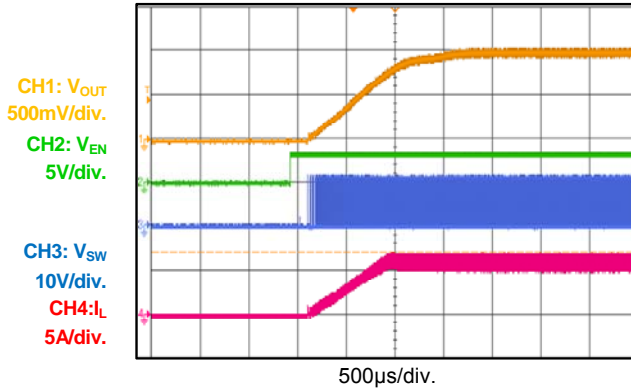

Shutdown through Enable

$I_{OUT} = 6A$

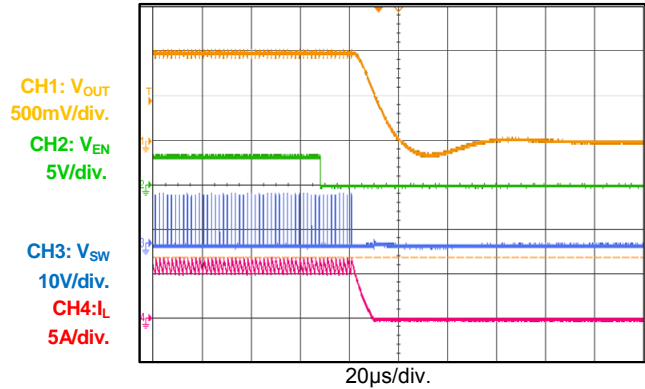

Input / Output Ripple

$I_{OUT} = 0A$

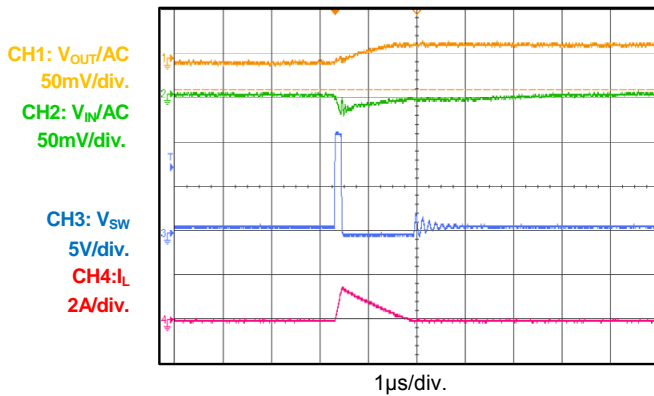

Input / Output Ripple

$I_{OUT} = 6A$

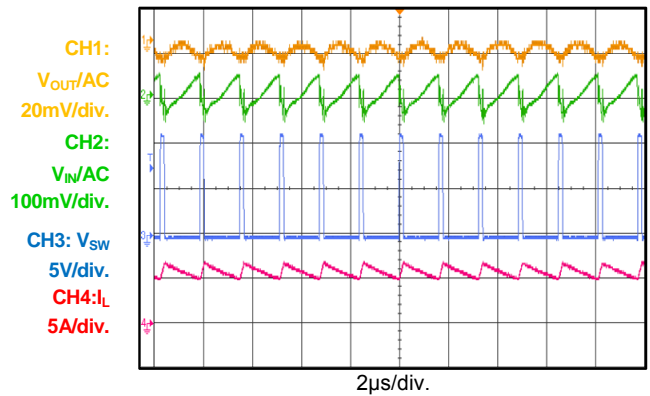

Transient Response

$I_{OUT} = 3A-6A$, Slew rate = $2.5A/\mu s$ by Eload

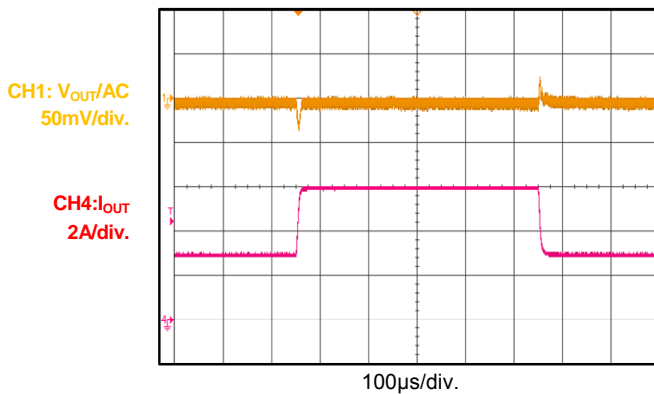

Short Circuit Entry

$I_{OUT} = 0A$

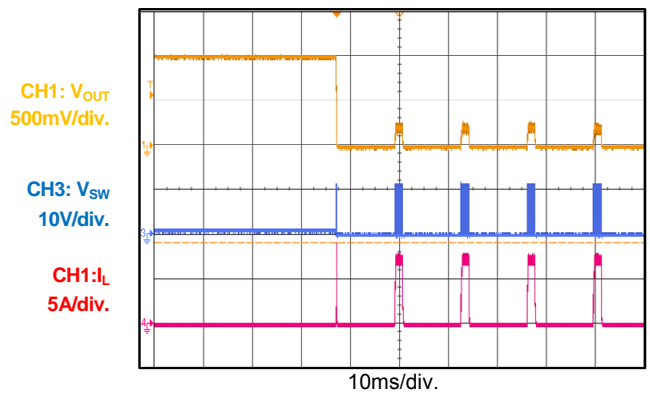

EVB TEST RESULTS *(continued)*

$V_{IN} = 12V$, $V_{OUT} = 1V$, $L = 1\mu H$, $T_A = +25^\circ C$, unless otherwise noted.

Short Circuit Recovery

$I_{OUT} = 0A$

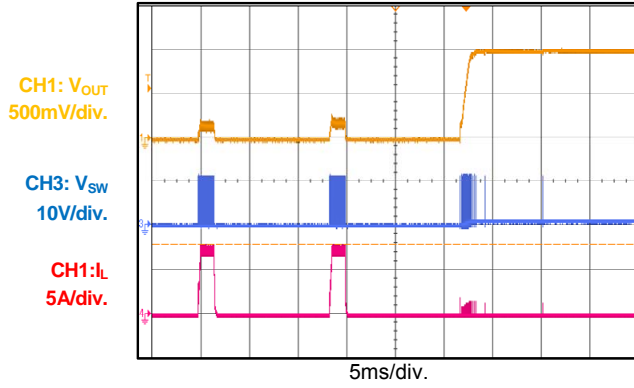

PRINTED CIRCUIT BOARD LAYOUT

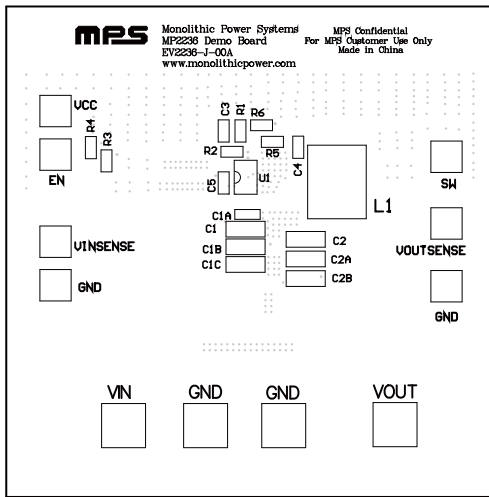

Figure 1—Top Silk Layer

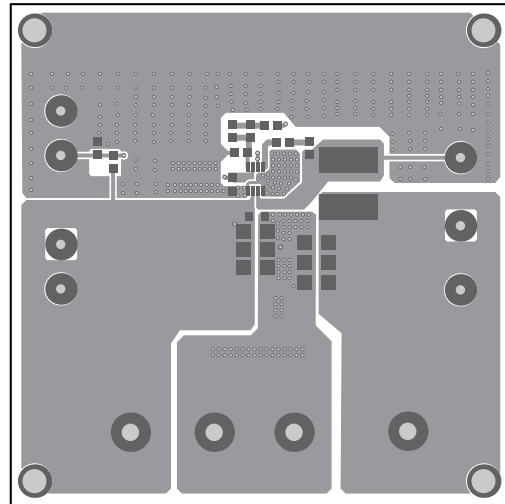

Figure 2—Top Layer

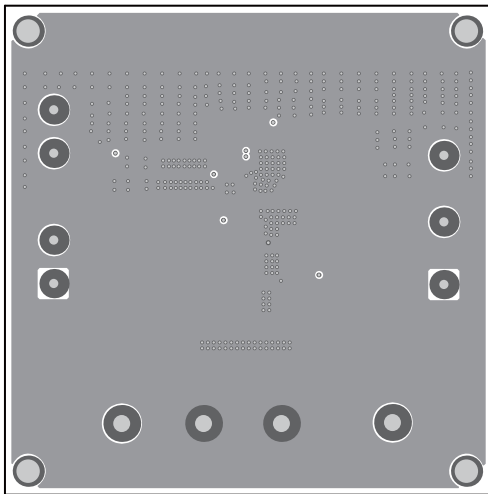

Figure 3—IN1 Layer

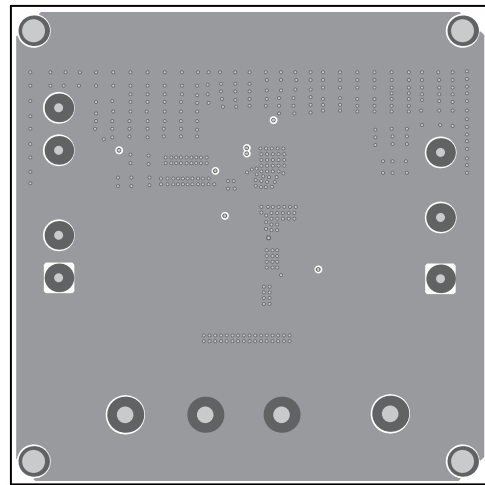

Figure 4—IN2 Layer

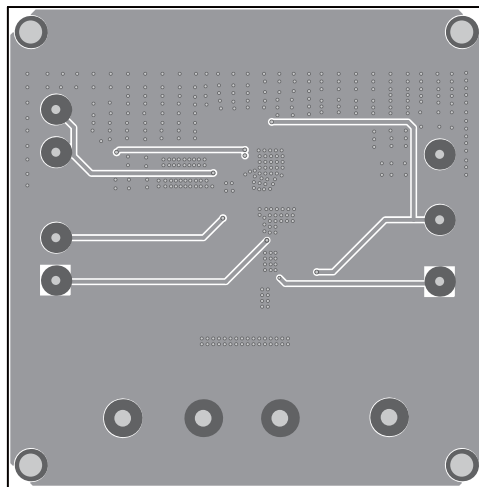

Figure 5—Bottom Layer

QUICK START GUIDE

1. Preset Power Supply to 12V.
2. Turn Power Supply off.
3. Connect Power Supply terminals to:
 - a. Positive (+): VIN
 - b. Negative (-): GND
4. Connect Load to:
 - a. Positive (+): VOUT
 - b. Negative (-): GND
5. Turn Power Supply on after making connections. The board will automatically start up.
6. To use the Enable function, apply a digital input to the EN pin. Drive EN higher than 1.3V to turn on the regulator, or less than 0.9V to turn it off.

NOTICE: The information in this document is subject to change without notice. Please contact MPS for current specifications. Users should warrant and guarantee that third party Intellectual Property rights are not infringed upon when integrating MPS products into any application. MPS will not assume any legal responsibility for any said applications.