



The Future of Analog IC Technology®

EV9942-J-00A

High Efficiency 2A, 36V, 410kHz Sync. Step-Down Switch Evaluation Board With Power Good

PRELIMINARY SPECIFICATIONS SUBJECT TO CHANGE

DESCRIPTION

The MP9942 is a high-frequency, synchronous, rectified, step-down, switch-mode converter with built-in power MOSFETs. It offers a very compact solution to achieve a 2A continuous output current with excellent load and line regulation over a wide input supply range. The MP9942 has synchronous mode operation for higher efficiency over the output current load range.

Current-mode operation provides fast transient response and eases loop stabilization.

Full protection features include over-current protection and thermal shut down.

The MP9942 requires a minimal number of readily-available standard external components, and is available in a space-saving 8-pin TSOT23 package.

ELECTRICAL SPECIFICATIONS (1)

Parameter	Symbol	Value	Units
Input Voltage	Continuous	12	V
Output Voltage	V _{OUT}	3.3	V
Output Current	I _{OUT}	0-2	A

Notes:

- 1) For different Input/output voltage specs and different output capacitor/inductor may need change the application circuit parameters.

FEATURES

- Wide 4V to 36V Continuous Operating Input Range
- 90mΩ/55mΩ Low R_{DS(ON)} Internal Power MOSFETs
- High-Efficiency Synchronous Mode Operation
- 410kHz Switching Frequency
- Synchronizes from 200kHz to 2.2MHz External Clock
- High Duty Cycle for Automotive Cold-crank
- Internal Power-Save Mode
- Internal Soft-Start
- Power Good Indicator
- Over-Current Protection with Hiccup
- Thermal Shutdown
- Output Adjustable from 0.8V
- Available in an 8-Pin TSOT23 Package

PACKAGEAPPLICATIONS

- Automotive
- Industrial Control System
- Distributed Power Systems

All MPS parts are lead-free and adhere to the RoHS directive. For MPS green status, please visit MPS website under Products, Quality Assurance page.

"MPS" and "The Future of Analog IC Technology" are registered trademarks of Monolithic Power Systems, Inc.

TYPICAL APPLICATION



(L x W x H) 6.3cm x 4.9cm x 1.3cm

Board Number	MPS IC Number
EV9942-J-00A	MP9942GJ

Efficiency vs. Load Current

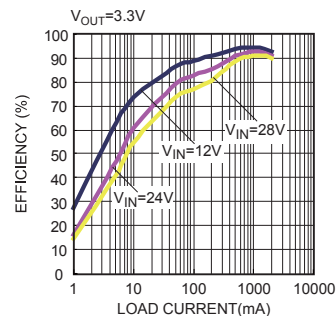

EVALUATION BOARD SCHEMATIC

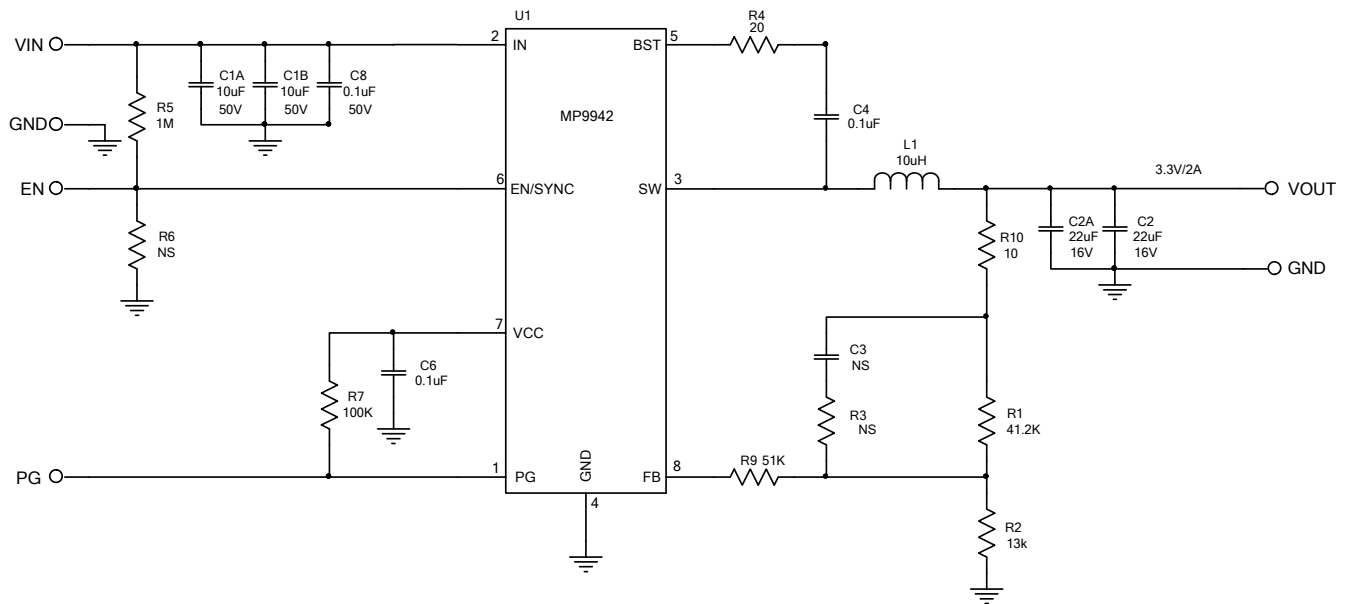

EV9942 BILL OF MATERIALS

Qty	Ref	Value	Description	Package	Manufacturer	Manufacturer P/N
2	C1A, C1B	10 μ F	Ceramic Cap., 50V, X7R	1210	muRata	GRM32ER71H106KA12L
1	C8	0.1 μ F	Ceramic Cap., 50V, X5R	0603	muRata	GRM188R71H104KA93D
2	C2,C2A	22 μ F	Ceramic Cap., 16V, 20%, X5R	1206	muRata	GRM32ER71C226KE79
1	C3	NS				
1	C4	0.1 μ F	Ceramic Cap., 50V, X5R	0603	muRata	GRM188R71H104KA93D
1	C6	0.1 μ F	Ceramic Cap., 50V, X5R	0603	muRata	GRM188R71H104KA93D
1	R1	41.2k	Thick Film Res., 1%	0603	Yageo	RC0603FR-0741K2L
1	R2	13k	Thick Film Res., 1%	0603	Yageo	RC0603FR-0713KL
1	R3	NS				
1	R4	20 Ω	Thick Film Res., 1%	0603	Yageo	RC0603FR-0720RL
1	R5	1M	Thick Film Res., 1%	0603	Yageo	RC0603FR-071ML
0	R6	NS				
1	R7	100k	Thick Film Res., 1%	0603	Yageo	RC0603FR-07100KL
1	R9	51k	Thick Film Res., 1%	0603	Yageo	RC0603FR-0751KL
1	R10	10 Ω	Thick Film Res., 1%	0603	Yageo	RC0603FR-0710RL
1	L1	10 μ H	Inductor, DCR=33m Ω , I _S =4A	SMD	Wurth	744314101
1	U1	MP9942GJ	Synchronous Step- Down Converter	TSOT23- 8	MPS	MP9942GJ

EVB TEST RESULTS

Performance waveforms are tested on the evaluation board.

$V_{IN} = 12V$, $V_{OUT} = 3.3V$, $L = 10\mu H$, $R_{BST}=20\Omega$, $T_A = +25^\circ C$, unless otherwise noted.

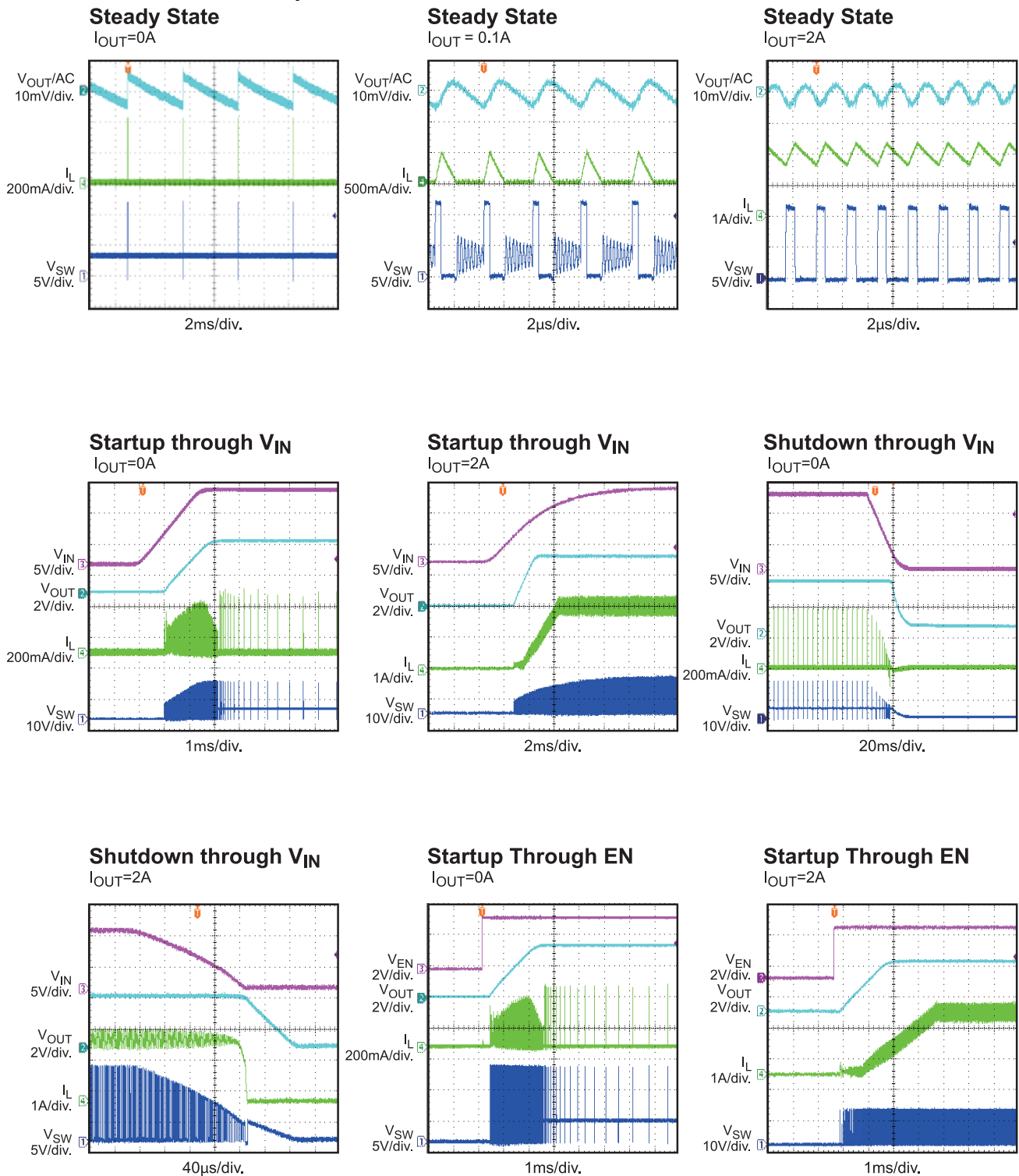

EVB TEST RESULTS (continued)

Performance waveforms are tested on the evaluation board.

$V_{IN} = 12V$, $V_{OUT} = 3.3V$, $L = 10\mu H$, $R_{BST} = 20\Omega$, $T_A = +25^\circ C$, unless otherwise noted.

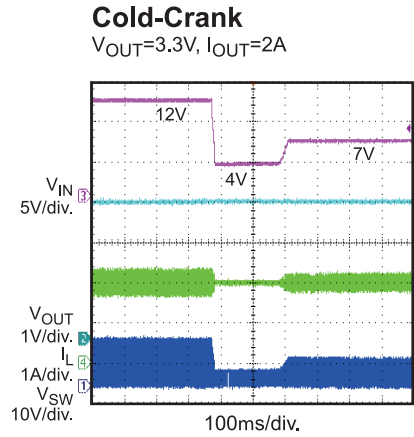
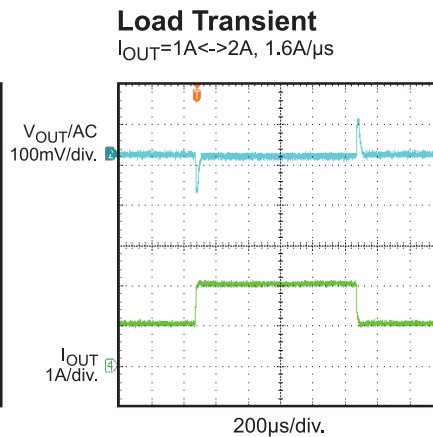
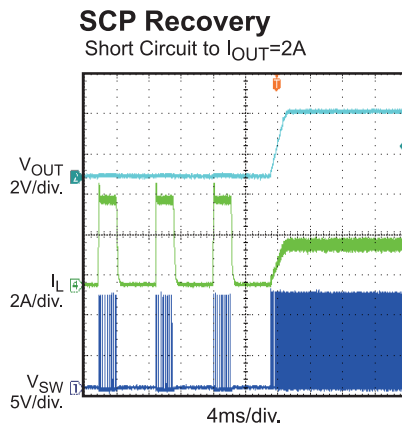
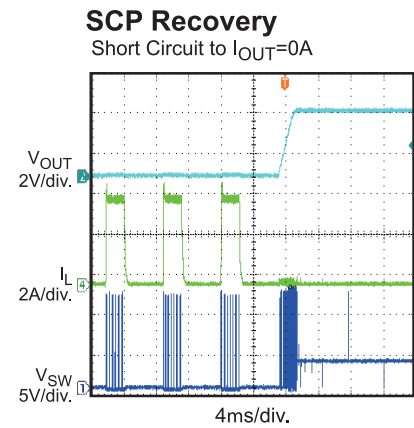
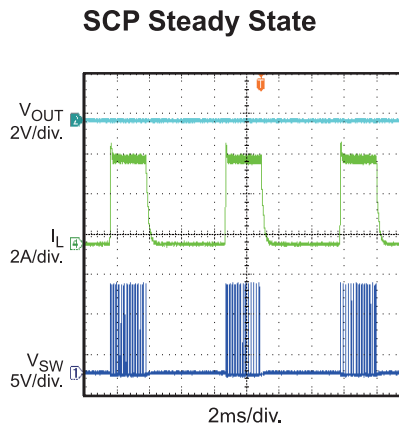
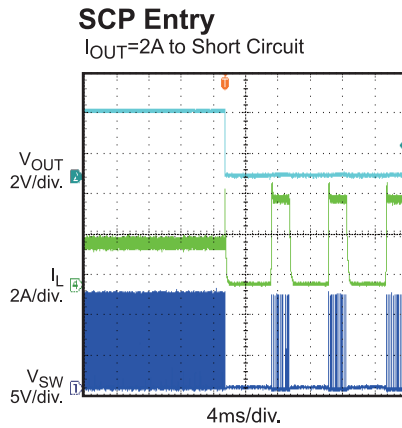
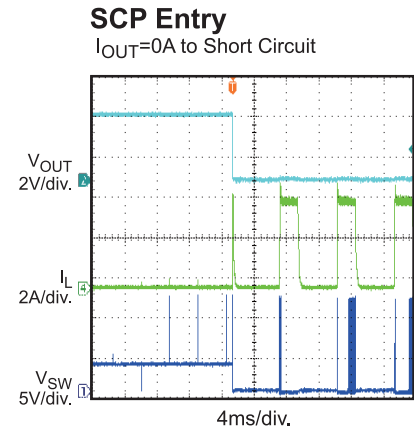
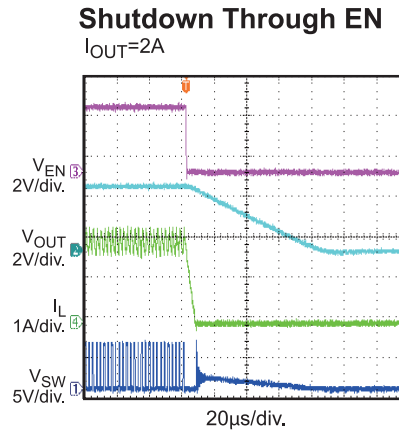
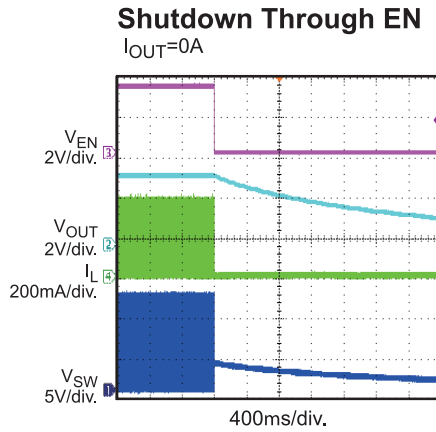

EVB TEST RESULTS *(continued)*

Performance waveforms are tested on the evaluation board.

$V_{IN} = 12V$, $V_{OUT} = 3.3V$, $L = 10\mu H$, $R_{BST} = 20\Omega$, $T_A = +25^\circ C$, unless otherwise noted.

Cold-Crank

$V_{OUT} = 5V$, $I_{OUT} = 2A$

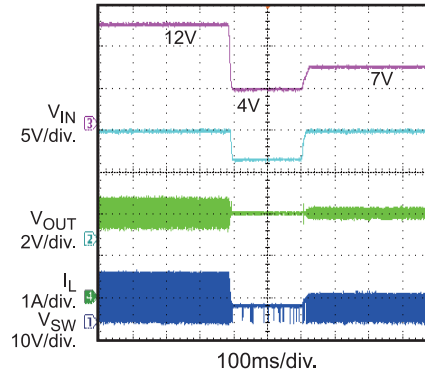

PRINTED CIRCUIT BOARD LAYOUT

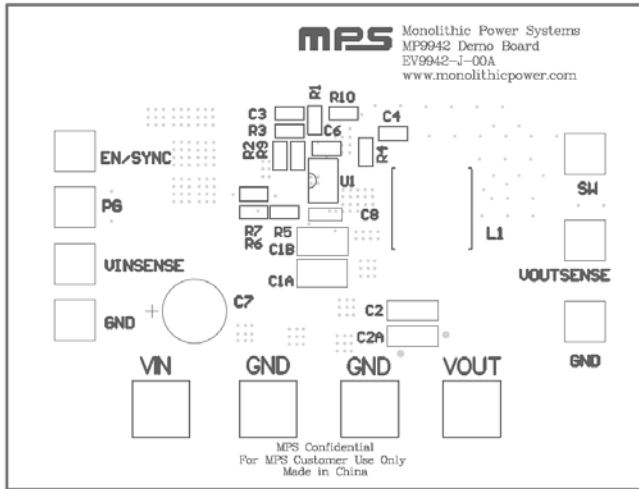

Figure 1—Top Silk Layer

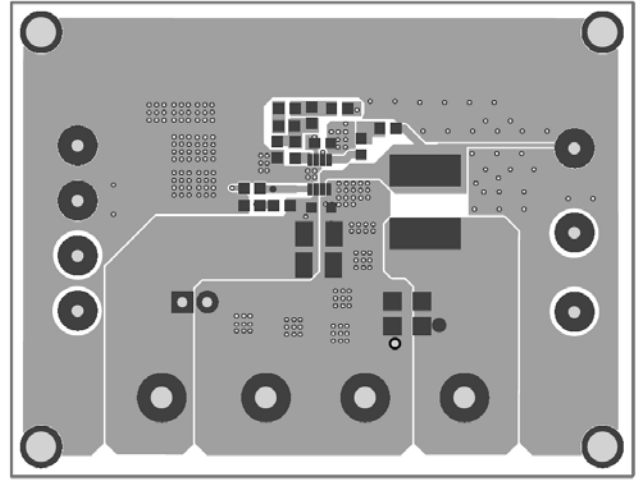

Figure 2—Top Layer

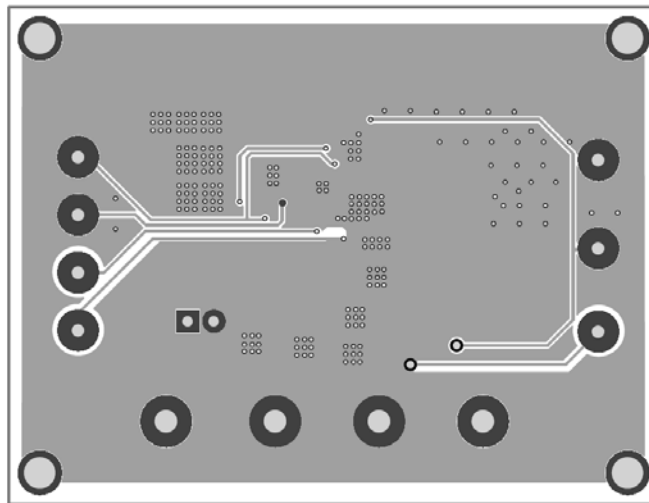

Figure 4—Bottom Layer

QUICK START GUIDE

1. Connect the positive and negative terminals of the load to the VOUT and GND pins, respectively.
2. Preset the power supply output between 4V and 36V, and then turn off the power supply.
3. Connect the positive and negative terminals of the power supply output to the VIN and GND pins, respectively.
4. Turn the power supply on. The MP9942 will automatically startup.
5. To use the Enable function, apply a digital input to the EN pin. Drive EN higher than 1.4V to turn on the regulator or less than 1.25V to turn it off.
6. To use the external synchronous function to adjust the switching frequency, apply an external clock signal to EN/SYNC pin.

NOTICE: The information in this document is subject to change without notice. Please contact MPS for current specifications. Users should warrant and guarantee that third party Intellectual Property rights are not infringed upon when integrating MPS products into any application. MPS will not assume any legal responsibility for any said applications.