

# SPECIFICATIONS

<b>Customer</b>	
<b>Product Name</b>	<b>Mini Molded Chip Power Inductor</b>
<b>Sunlord Part Number</b>	<b>MWTC1412065SR24MTB02</b>
<b>Customer Part Number</b>	

New Released,  Revised]

**SPEC No.:** MWTC0611260001

**【This SPEC is total 11 pages】**

**【ROHS, Compliant Parts】**

Approved By	Checked By	Issued By
		

## Shenzhen Sunlord Electronics Co., Ltd.

Address: Sunlord Industrial Park, Dafu Industrial Zone, Longhua, Shenzhen, China 518110  
 Tel: 0086-755-29832333 Fax: 0086-755-82269029 E-Mail: sunlord@sunlordinc.com

**【For Customer approval Only】**

Date: \_\_\_\_\_

Qualification Status:  Full  Restricted  Rejected

Approved By	Verified By	Re-checked By	Checked By

Comments:

\_\_\_\_\_

**【Version change history】**

Rev.	Effective Date	Changed Contents	Change Reasons	Approved By
01	Feb.02,2026	New release	/	Baizhi Liu

#### Caution

All products listed in this specification are developed, designed and intended for use in general electronics equipment. The products are not designed or warranted to meet the requirements of the applications listed below, whose performance and/or quality require especially high reliability, or whose failure, malfunction or trouble might directly cause damage to society, person, or property. Please understand that we are not responsible for any damage or liability caused by use of the products in any of the applications below. Please contact us for more details if you intend to use our products in the following applications.

1. Aircraft equipment
2. Aerospace equipment
3. Undersea equipment
4. nuclear control equipment
5. military equipment
6. Power plant equipment
7. Medical equipment
8. Transportation equipment (automobiles, trains, ships,etc.)
9. Traffic signal equipment
10. Disaster prevention / crime prevention equipment
11. Applications of similar complexity or with reliability requirements comparable to the applications listed in the above

1. Scope

This specification applies to MWTC1412065SR24MTB02 of Mini Molded Chip Power Inductor.

2. Product Description and Identification (Part Number)

2.1 Description

MWTC1412065SR24MTB02 of Mini Molded Chip Power Inductor.

2.2 Product Identification (Part Number)

MWTC 1412065 S R24 M T B02  
 ① ② ③ ④ ⑤ ⑥ ⑦

① Type	
MWTC	Mini Molded Chip Power Inductor

② External Dimensions (L x W xH) (mm)	
1412065	1.4x1.2x0.65

③ Feature Type	
S	Standard

④ Nominal Inductance	
Example	Nominal Value
R24	0.24μH

⑤ Inductance Tolerance	
M	±20%

⑦ Internal Code	
B02	Design code

⑥ Packing	
T	Tape Carrier Package

3. Electrical Characteristics

Please refer to Appendix A (Page 11).

3.1 Operating and storage temperature range (individual chip without packing): -40°C ~ +125°C

3.2 Storage temperature range (packaging conditions): -10°C~+40°C and RH 70% (Max.)

4. Shape and Dimensions

4.1 Dimensions and recommended PCB pattern for reflow soldering: See Fig.4-1, Fig.4-2 and Table 4-1.

4.2 Structure: See Fig. 4-3 and Fig. 4-4.

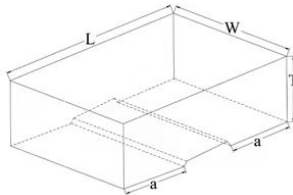

Fig. 4-1

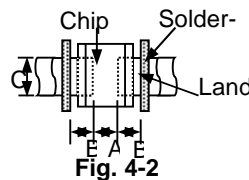

Fig. 4-2

[Table 4-1]

Unit: mm [inch]

Type	L	W	T	a	A	B	C
1412065	1.4±0.2 [.055±.008]	1.2±0.2 [.047±.008]	0.65MAX [.026MAX]	0.4±0.15 [.016±.006]	0.5 Typ	0.6 Typ	1.2 Typ

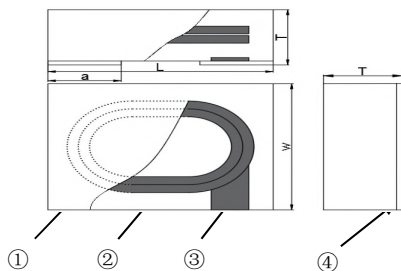

Fig. 4-3

Structure of Electro-plating

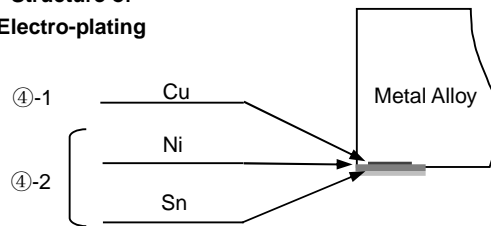

Fig. 4-4

4.3 Material Information: See Table 4-2.

[Table 4-2]

Code	Part Name	Material Name
①	Metal Alloy Body	Metal Alloy Powder
②	Inner Coils	Cu Coil
③	Pull-out Electrode (Cu)	Cu
④-1	Terminal Electrode: Inside Cu	Plating Chemicals
④-2	Electro-Plating: Ni/Sn plating	Plating Chemicals

5 Test and Measurement Procedures

5.1 Test Conditions

5.1.1 Unless otherwise specified, the standard atmospheric conditions for measurement/test as:

- a. Ambient Temperature: 20±15°C
- b. Relative Humidity: 65±20%
- c. Air Pressure: 86kPa to 106kPa

5.1.2 If any doubt on the results, measurements/tests should be made within the following limits:

- a. Ambient Temperature: 20±2°C
- b. Relative Humidity: 65±5%
- c. Air Pressure: 86kPa to 106kPa

5.2 Visual Examination

- a. Inspection Equipment: 20x magnifier

5.3 Electrical Test

5.3.1 DC Resistance (DCR)

- a. Refer to **Electrical Characteristics**.
- b. Test equipment (Analyzer): High Accuracy Milliohmmeter-HIOKI RM3544 or equivalent.

5.3.2 Inductance (L)

- a. Refer to **Electrical Characteristics**.
- b. Test equipment: High Accuracy RF Impedance /Material Analyzer-WK 3260B or equivalent.
- c. Test signal:1V.
- d. Test frequency refers to **Electrical Characteristics**.

5.3.3 Temperature Rise Current (I<sub>rms</sub>)

- a. Refer to **Electrical Characteristics**.
- b. Test equipment (see Fig. 5.3.3-1): Electric Power, Electric current meter, Thermometer.
- c. Measurement method (see Fig. 5.3.3-1):
  - 1) Set test current to be 0 mA.
  - 2) Measure initial temperature of chip surface.
  - 3) Gradually increase voltage and measure chip temperature for corresponding current.
  - 4) Definition of Temperature Rise Current (I<sub>rms</sub>) : I<sub>rms</sub> is direct electric current as chip surface temperature rose just 40°C against chip initial surface temperature (T<sub>a</sub>) (see Fig. 5.3.3-2)

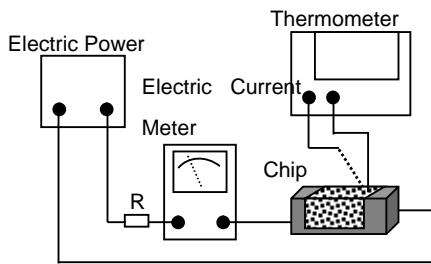

Fig. 5.3.3-1

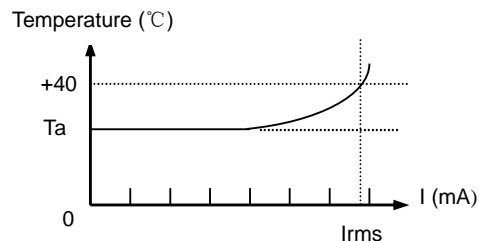

Fig. 5.3.3-2

5.3.4 Saturation Current (I<sub>sat</sub>)

- a. Refer to **Electrical Characteristics**.
- b. Test equipment: High Accuracy RF Impedance /Material Analyzer- WK 3260B or equivalent.
- c. Measurement method:
  - 1) Measurement conditions of initial inductance L: Measuring Frequency: 1MHz.  
Test voltage: 1V.
  - 2) Definition of Saturation Current (I<sub>sat</sub>) : I<sub>sat</sub> is the value of DC current as inductance L (μH) decreased just 30% against initial value (see Fig. 5.3.4-1).

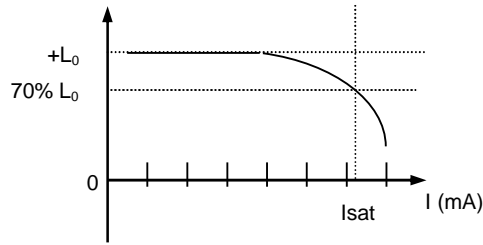
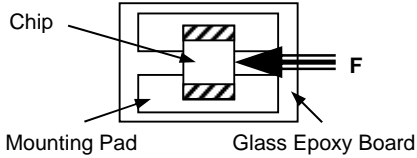
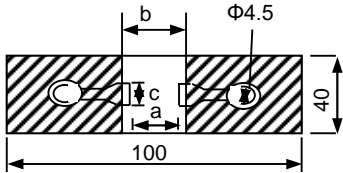
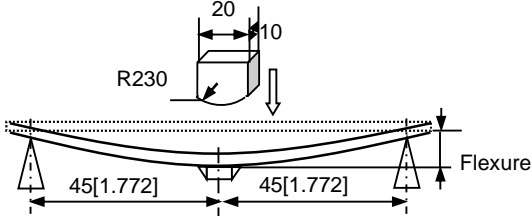
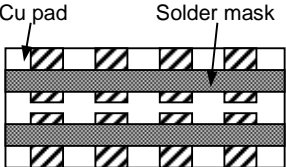

Fig. 5.3.4-1

5.3.5 Self-Resonant Frequency (SRF)

- a. Refer to **Electrical Characteristics**.
- b. Test equipment: High Accuracy RF Impedance /Material Analyzer--WK 3260B or equivalent.
- c. Test signal: 1V.

5.4 Reliability Test

Items	Requirements	Test Methods and Remarks								
5.4.1 Terminal Strength	No removal or split of the termination or other defects shall occur.  <p style="text-align: center;">Fig.5.4.1-1</p>	① Solder the inductor to the testing jig (glass epoxy board shown in Fig.5.4.1-1) using eutectic solder. Then apply a 5N force in the direction of the arrow. ② Keep time: 10±1s. ③ Speed: 1.0mm/s.								
5.4.2 Resistance to Flexure	No visible mechanical damage. Unit: mm [inch] <table border="1" data-bbox="309 1059 732 1144" style="margin-left: auto; margin-right: auto;"> <thead> <tr> <th>Type</th> <th>a</th> <th>b</th> <th>c</th> </tr> </thead> <tbody> <tr> <td>1412065</td> <td>0.5</td> <td>1.6</td> <td>1.4</td> </tr> </tbody> </table>  <p style="text-align: center;">Fig.5.4.2-1</p>	Type	a	b	c	1412065	0.5	1.6	1.4	① Solder the inductor to the test jig (glass epoxy board shown in Fig.5.4.2-1) Using a eutectic solder. Then apply a force in the direction shown Fig. 5.4.2-2. ② Flexure: 2mm. ③ Pressurizing Speed: 0.5mm/sec. ④ Keep time: 30 sec. ⑤ Test board size: 100X40X1.0.  <p style="text-align: center;">Fig. 5.4.2-2</p>
Type	a	b	c							
1412065	0.5	1.6	1.4							
5.4.3 Vibration	① No visible mechanical damage. ② Inductance change: Within ±10%.  <p style="text-align: center;">Glass Epoxy Board Fig. 5.4.3-1</p>	① Solder the inductor to the testing jig (glass epoxy board shown in Fig.5.4.3-1) using eutectic solder. ② The inductor shall be subjected to a simple harmonic motion having total amplitude of 1.5mm, the frequency being varied uniformly between the approximate limits of 10 and 55 Hz. ③ The frequency range from 10 to 55 Hz and return to 10 Hz shall be traversed in approximately 1 minute. This motion shall be applied for a period of 2 hours in each 3 mutually perpendicular directions (total of 6 hours).								
5.4.4 Dropping	① No visible mechanical damage. ② Inductance change: Within ±10%.	Drop chip inductor 10 times on a concrete floor from a height of 100 cm.								
5.4.5 Temperature	Inductance change should be within ±20% of initial value measuring at 25°C.	Temperature range: -40°C ~ +125°C Reference temperature: +25°C								
5.4.6 Solderability	① No visible mechanical damage. ② Wetting shall exceed 90% coverage.	① Solder temperature: 245±2°C ② Duration: 3 sec. ③ Solder: Sn/3.0Ag/0.5Cu. ④ Flux: 25% Resin and 75% ethanol in weight.								

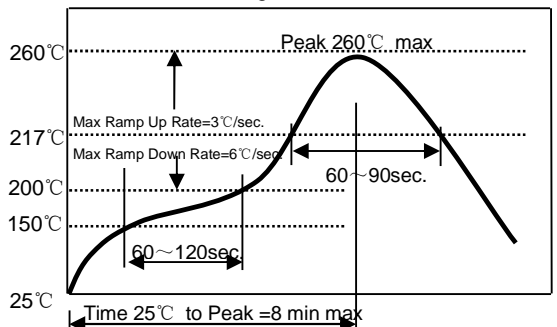
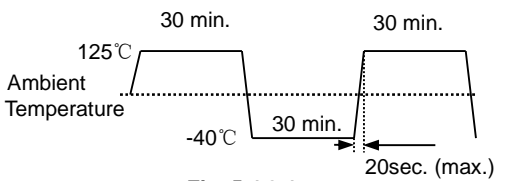
<p>5.4.7 Resistance to Soldering Heat</p>	<p>① No visible mechanical damage. ② Inductance change: Within <math>\pm 10\%</math>.</p>	<p>① Re-flowing Profile: Please refer to Fig. 5.4.7-1. ② Test board thickness: 1.0mm ③ Test board material: glass epoxy resin ④ The chip shall be stabilized at normal condition for 1~2 hours before measuring</p> 
<p>5.4.8 Thermal Shock</p>	<p>① No mechanical damage. ② Inductance change: Within <math>\pm 10\%</math>.</p>  <p style="text-align: center;"><b>Fig. 5.4.8-1</b></p>	<p>① Temperature, Time: (See Fig.5.4.8-1) -40°C for 30<math>\pm</math>3 min<math>\rightarrow</math> 125°C for 30<math>\pm</math>3min. ② Transforming interval: 20 sec.(max.). ③ Tested cycle: 100 cycles. ④ The chip shall be stabilized at normal condition for 1~2 hours before measuring.</p>
<p>5.4.9 Resistance to Low Temperature</p>	<p>① No mechanical damage. ② Inductance change: Within <math>\pm 10\%</math>.</p>	<p>① Temperature: -40<math>\pm</math>2°C ② Duration: 1000+24 hours. ③ The chip shall be stabilized at normal condition for 1~2 hours before measuring.</p>
<p>5.4.10 Resistance to High Temperature</p>	<p>① No mechanical damage. ② Inductance change: Within <math>\pm 10\%</math>.</p>	<p>① Temperature: 125<math>\pm</math>2°C ② Duration: 1000+24 hours. ③ The chip shall be stabilized at normal condition for 1~2 hours before measuring.</p>
<p>5.4.11 Damp Heat (Steady States)</p>	<p>① No visible mechanical damage. ② Inductance change: Within <math>\pm 10\%</math>.</p>	<p>① Temperature: 60<math>\pm</math>2°C ② Humidity: 90% to 95% RH. ③ Duration: 1000+24 hours. ④ The chip shall be stabilized at normal condition for 1~2 hours before measuring.</p>
<p>5.4.12 Loading Under Damp Heat</p>	<p>① No visible mechanical damage. ② Inductance change: Within <math>\pm 10\%</math>.</p>	<p>① Temperature: 60<math>\pm</math>2°C ② Humidity: 90% to 95% RH. ③ Duration: 1000+24 hours. ④ Applied current: Rated current. ⑤ The chip shall be stabilized at normal condition for 1~2 hours before measuring.</p>
<p>5.4.13 Loading at High Temperature (Life Test)</p>	<p>① No visible mechanical damage. ② Inductance change: Within <math>\pm 10\%</math>.</p>	<p>① Temperature: 85<math>\pm</math>2°C ② Duration: 1000+24 hours. ③ Applied current: Rated current. ④ The chip shall be stabilized at normal condition for 1~2 hours before measuring.</p>

**6 Packaging and Storage**

**6.1 Packaging**

Tape Carrier Packaging:

Packaging code: T

6.1.1 Tape carrier packaging are specified in attached figure Fig.6.1-1~3

6.1.2 Tape carrier packaging quantity please see the following table:

Type	1412065
T(mm)	0.65MAX
Tape	Embossed Tape
Quantity	3K

- 6.1.3 Reel shall be packaged in vinyl bag.
- 6.1.4 Maximum of 5 or 10 reels bags shall be packaged in an inner box.
- 6.1.5 Maximum of 6 or 10 inner boxes shall be packaged in an outer case.

(1) Taping Drawings (Unit: mm)

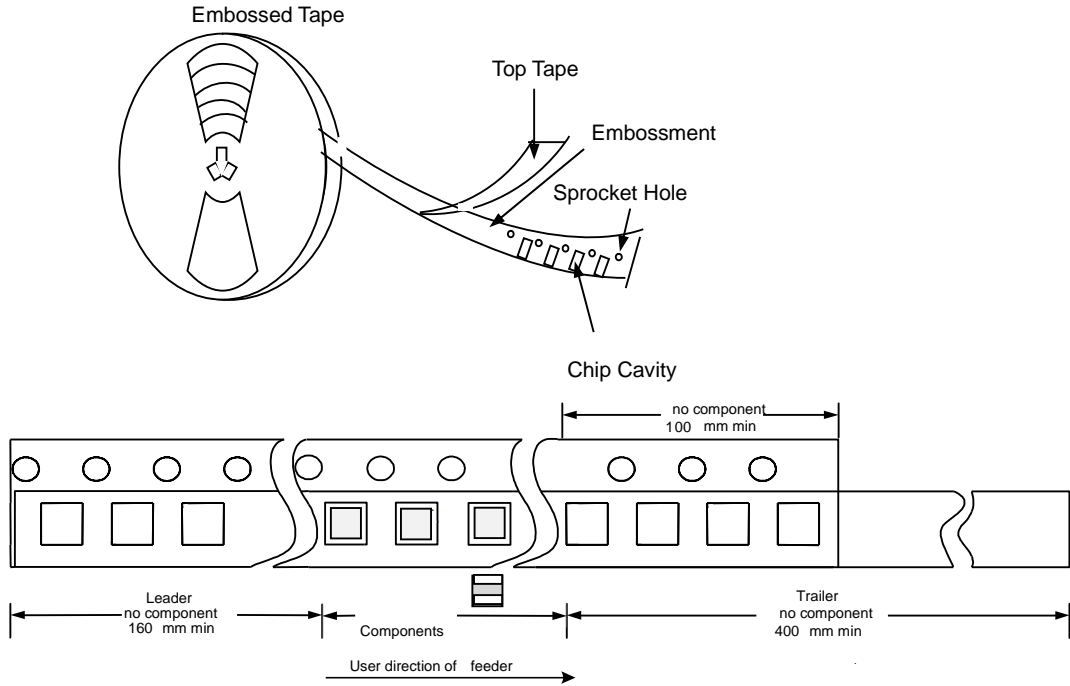

Fig. 6.1-1

**Remark:** The sprocket holes are to the right as the tape is pulled toward the user.

(2) Taping Dimensions (Unit: mm)

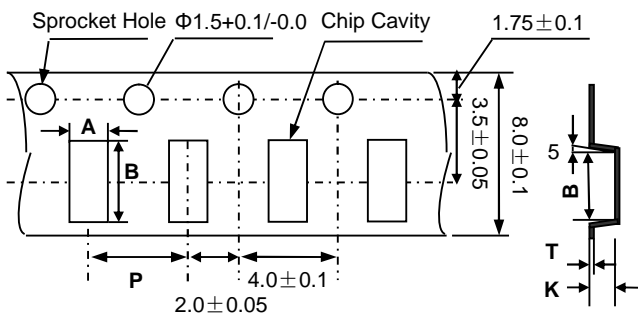
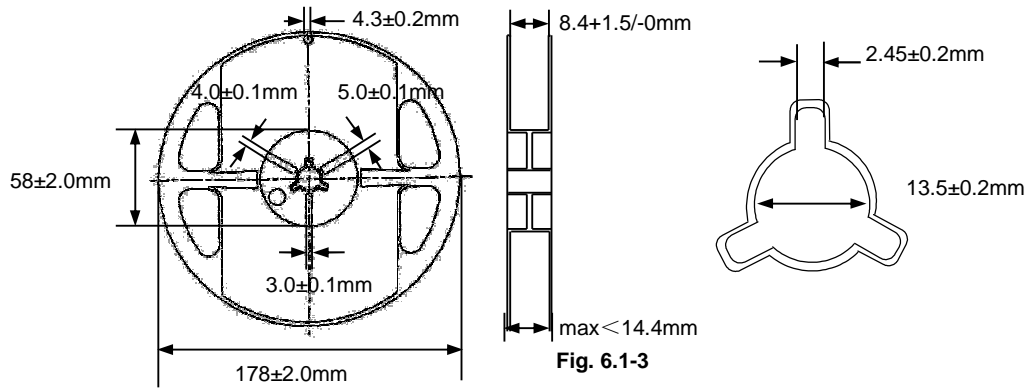

Fig. 6.1-2

Type	A	B	P	Kmax	Tmax
MWTC1412065	1.5±0.1	1.7±0.1	4.0±0.1	1.0	0.3

(3) Reel Dimensions (Unit: mm)



6.2 Storage

6.2.1 To maintain the solderability of terminal electrodes and to keep the packing material in good condition, temperature and humidity in the storage area should be controlled.

6.2.2 Recommended conditions: -10°C~40°C, 70%RH (Max.)

6.2.3 Even under ideal storage conditions, solderability of products electrodes may decrease as time passes. For this reason, product should be used with one year from the time of delivery.

7 Visual inspection standard of product

File No:		Applied to assembled large current choke inductor Series		REV: 01
Effective date:				
No.	Defect Item	Graphic	Rejection identification	Acceptance
1	Core defect		The defect length and width (L and W) more than L/4 and W/4, NG.	AQL=0.65
2	Tin point		Electrode surface: 1. The climbing length of tin is greater than 1/4 of the electrode spacing,NG. Print literally: 1. The length and width (L and W) of tin point is greater than 0.20 mm and the quantity is more than 8, NG. 2. The length and width of tin dots are less than 0.05mm, which is not considered. Side: 1. The climbing height of tin is greater than 1/2 of the product height, NG.	AQL=0.65

8. Recommended Soldering Technologies

8.1 Reflowing Profile:

- △ Preheat condition: 150 ~200°C/60~120sec.
- △ Allowed time above 217°C: 60~90sec.
- △ Max temp: 260°C
- △ Max time at max temp: 10sec.
- △ Solder paste: Sn/3.0Ag/0.5Cu
- △ Allowed Reflow time: 3x max

[Note: The reflow profile in the above table is only for qualification and is not meant to specify board assembly profiles. Actual board assembly profiles must be based on the customer's specific board design, solder paste and process, and should not exceed the parameters as the Reflow profile shows.]

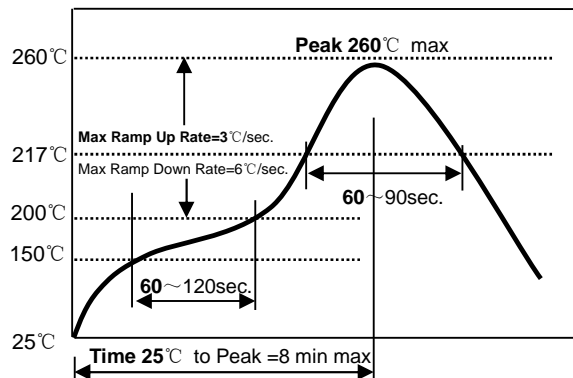

**8.2 Iron Soldering Profile.**

- △ Iron soldering power: Max.30W
- △ Pre-heating: 150 °C / 60sec.
- △ Soldering Tip temperature: 350°C Max.
- △ Soldering time: 3sec Max.
- △ Solder paste: Sn/3.0Ag/0.5Cu
- △ Max.1 times for iron soldering

[Note: Take care not to apply the tip of the soldering iron to the terminal electrodes.]

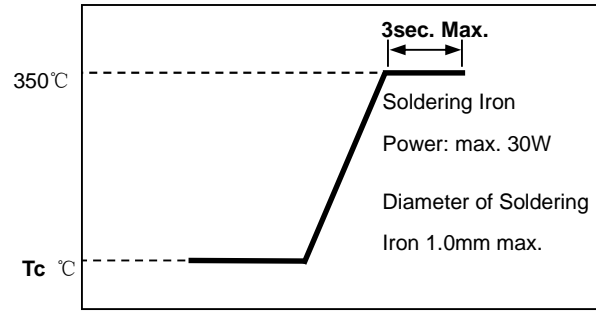

Appendix A: Electrical Characteristics

Electrical Characteristics Part Number	L	L Test Freq.	S.R.F Min.	DC Resistance		Saturation Current (Isat)		Temperature Rise Current (Irms)		Thickness
				Typ.	Max.	Typ.	Max.	Typ.	Max.	
Unit	μH	MHz	MHz	mΩ	mΩ	A	A	A	A	mm [inch]
MWTC1412065SR24MTB02	0.24	1	125	19.5	23.5	6.8	6.5	4.6	4.2	0.65MAX [.026MAX]

- ※: Please specify the inductance tolerance code (M=±20%, N=±30%).
- ※: Rated current: Isat or Irms, whichever is smaller.
- ※: Saturation Current: *Max. Value*, DC current at which the inductance drops less than 30% from its value without current;  
*Typ. Value*, DC current at which the inductance drops 30% from its value without current.
- ※: Temperature Rise Current: DC current that causes the temperature rise (ΔT) from 20°C ambient.  
For *Max. Value*, ΔT < 40°C; for *Typ. Value*, ΔT is approximate 40°C.
- ※: Rated voltage: 20V. When the use voltage exceeds the rated voltage, additional confirmation is required.

Inductance vs. Frequency Characteristics ■ Temperature vs. DC Current Characteristics ■ Inductance vs. DC Current Characteristics

