



MMIC SURFACE MOUNT

Wideband Amplifier

PMA3-83LP+

Mini-Circuits

50Ω 0.4 to 8 GHz +6 V Supply

THE BIG DEAL

- Output P1dB, Typ. +25 dBm
- Output IP3, Typ. +34 dBm
- Low Noise Figure, Typ. 2.8 dB
- Adjustable Supply Current
- 3x3mm 12-Lead QFN-style Package
- Patent Pending

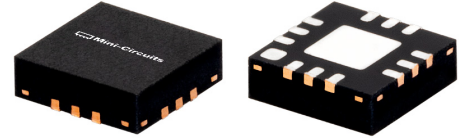

Generic photo used for illustration purposes only

APPLICATIONS

- Wi-Fi 6
- 5G MIMO Radio Systems
- L, S, and C-band Radar
- SATCOM

FUNCTIONAL DIAGRAM

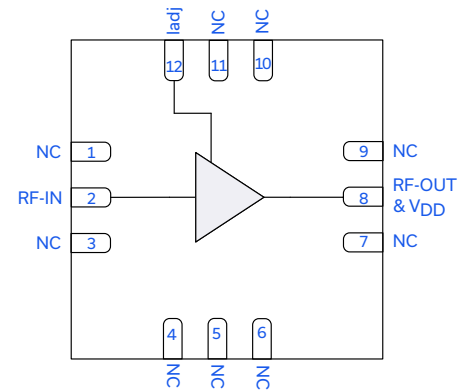

PRODUCT OVERVIEW

The PMA3-83LP+ is a GaAs pHEMT based wideband, low noise, MMIC amplifier with a unique combination of low noise figure, high OIP3, and high output power. This makes it ideal for sensitive, high-dynamic range receiver applications. The PMA3-83LP+ design operates on a single supply voltage of +6 V, is well matched for 50Ω, and comes in a low-profile package (3x3mm 12-Lead), which can accommodate dense circuit board layouts.

KEY FEATURES

Feature	Advantages
Low Noise Figure, 2.8 dB Typ	Enables lower system noise figure performance.
High IP3: <ul style="list-style-type: none"> • +41 dBm at 0.4 GHz • +34 dBm at 2 GHz • +34 dBm at 4 GHz • +34 dBm at 6 GHz • +34 dBm at 8 GHz 	Combination of low noise figure and high IP3 makes this MMIC amplifier ideal for use in low noise receiver front end (RFE), as it gives the user advantages of sensitivity and two-tone IM performance at both ends of the dynamic range.
Output Power at 1 dB Compression, +25 dBm	Enables usage as a pre-driver or driver amplifier in a variety of transmit and receive applications in commercial, industrial, and defense systems. Adjustable supply current to optimize power efficiency.
3x3mm 12-lead QFN-style package	Tiny footprint saves space in dense layouts while providing low inductance, repeatable transitions, and excellent thermal contact to the PCB.
Wide bandwidth with flat gain <ul style="list-style-type: none"> • ±1.5 dB over 4 to 8 GHz 	Enables a single amplifier to be used in many wideband applications including defense, instrumentation, and more.





MMIC SURFACE MOUNT

Wideband Amplifier

PMA3-83LP+

50Ω 0.4 to 8 GHz +6 V Supply

ELECTRICAL SPECIFICATIONS¹ AT +25°C, V_{DD} = +6 V, UNLESS NOTED OTHERWISE

Parameter	Condition (MHz)	Min.	Typ.	Max.	Units
Frequency Range		400		8000	MHz
Gain	400	20.6	21.3		dB
	2000	19.9	20.5		
	4000	18.6	19.6		
	6000	17.8	18.8		
	8000	16.0	17.3		
Output Power at 1dB Compression (P _{1dB})	400		+25.0		dBm
	2000		+25.4		
	4000		+25.7		
	6000		+24.3		
	8000		+22.9		
Output Third-Order Intercept (P _{OUT} = +12dBm/Tone)	400		+41		dBm
	2000		+34		
	4000		+34		
	6000		+34		
	8000		+34		
Input Return Loss	400		12		dB
	2000		12		
	4000		12		
	6000		15		
	8000		12		
Output Return Loss	400		8		dB
	2000		13		
	4000		17		
	6000		11		
	8000		9		
Isolation	400-8000		28		dB
Noise Figure	400		3.3		dB
	2000		3.0		
	4000		2.6		
	6000		2.4		
	8000		2.7		
Device Operating Voltage (V _{DD})		+5.5	+6	+6.5	V
Device Operating Current (I _{DD}) ²			150		mA
Voltage at I _{adj} pin (V _{Iadj})			3.35		V
Current at I _{adj} pin (I _{Iadj})			1.21		mA
DC Current Variation vs. Temperature ³			-0.28		μA/°C
DC Current Variation vs. Voltage ⁴			44		mA/mV

1. Tested on Mini-Circuits Characterization Evaluation Board TB-PMA3-83LPC+. See Figure 2. Board loss de-embedded to the device.

2. Current at P_{IN} = -25dBm. Increases to 178mA at P_{1dB} at room temperature.

3. ((Current at 85°C - Current at -45°C)/(130°C)

4. ((Current at +6.5V in mA) - (Current at +5.5V in mA))/((+6.5V) - (+5.5V)*1000mA/mV)





TYPICAL PERFORMANCE GRAPHS

GAIN vs. TEMPERATURE,
 $P_{IN} = -25\text{dBm}$, $V_{DD} = +6\text{V}$

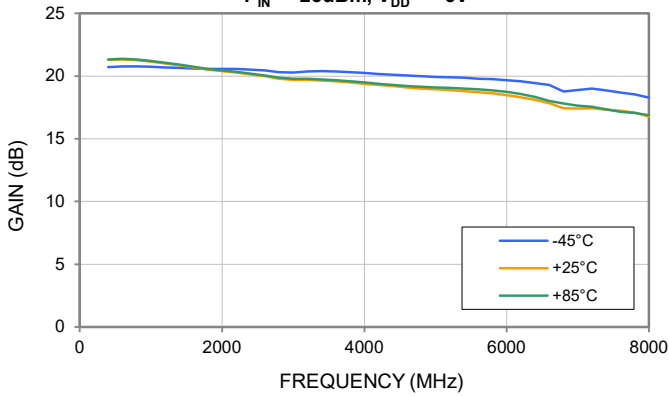

GAIN vs. DEVICE VOLTAGE,
 $P_{IN} = -25\text{dBm}$, TEMPERATURE = +25°C

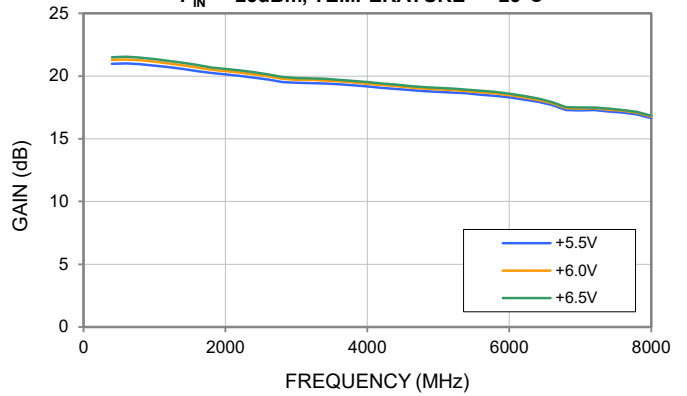

INPUT RETURN LOSS vs. TEMPERATURE,
 $P_{IN} = -25\text{dBm}$, $V_{DD} = +6\text{V}$

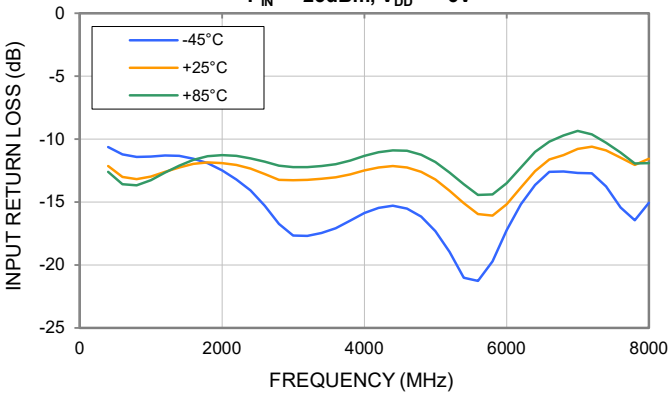

INPUT RETURN LOSS vs. DEVICE VOLTAGE,
 $P_{IN} = -25\text{dBm}$, TEMPERATURE = +25°C

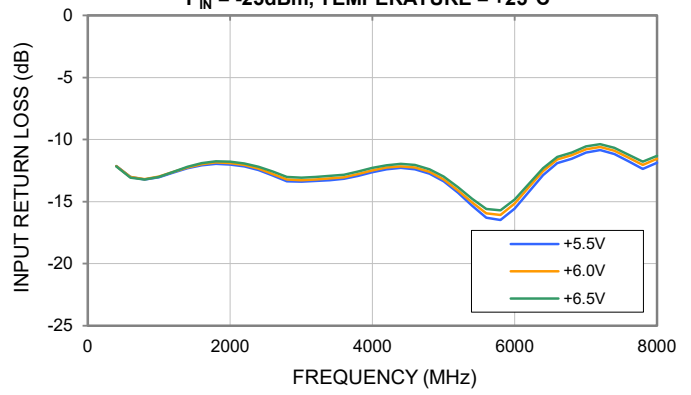

OUTPUT RETURN LOSS vs. TEMPERATURE,
 $P_{IN} = -25\text{dBm}$, $V_{DD} = +6\text{V}$

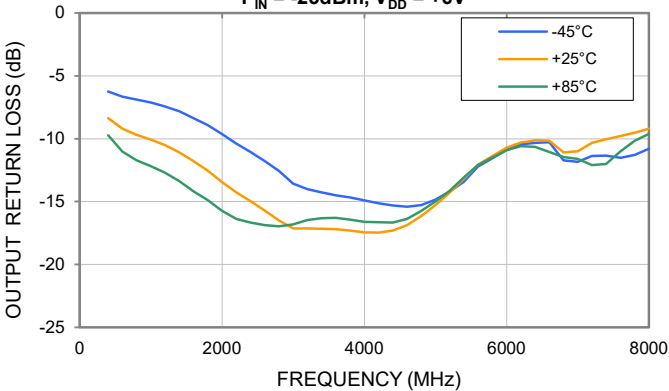

OUTPUT RETURN LOSS vs. DEVICE VOLTAGE,
 $P_{IN} = -25\text{dBm}$, TEMPERATURE = +25°C

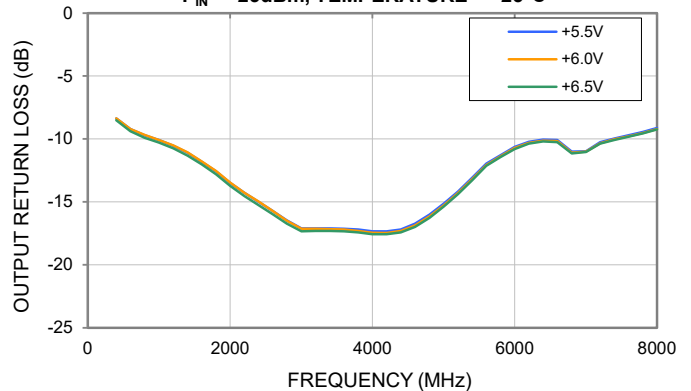



TYPICAL PERFORMANCE GRAPHS

ISOLATION vs. TEMPERATURE,
 $P_{IN} = -25\text{dBm}$, $V_{DD} = +6\text{V}$

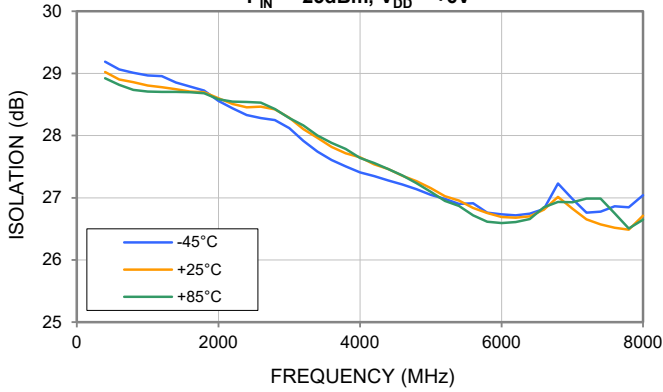

ISOLATION vs. DEVICE VOLTAGE,
 $P_{IN} = -25\text{dBm}$, TEMPERATURE = +25°C

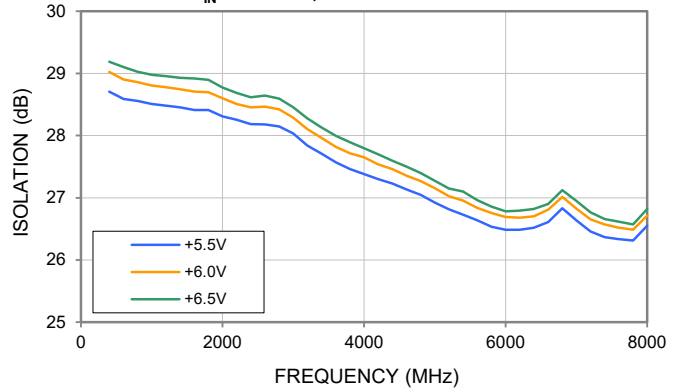

P1dB vs. TEMPERATURE,
 $V_{DD} = +6\text{V}$

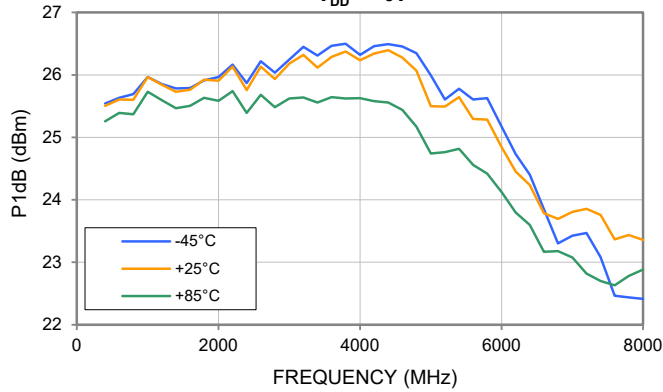

P1dB vs. DEVICE VOLTAGE,
TEMPERATURE = +25°C

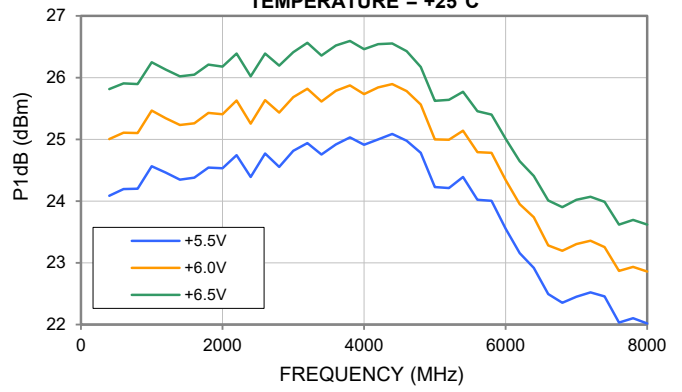

OUTPUT IP3 vs. TEMPERATURE,
 $P_{OUT} = +12\text{dBm/TONE}$, $V_{DD} = +6\text{V}$

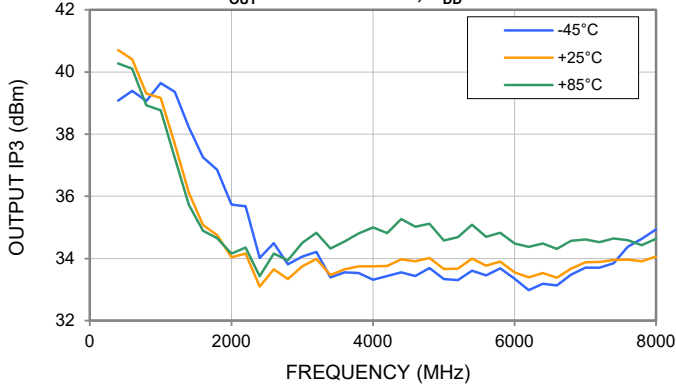

OUTPUT IP3 vs. DEVICE VOLTAGE,
 $P_{OUT} = +12\text{dBm/TONE}$, TEMPERATURE = +25°C

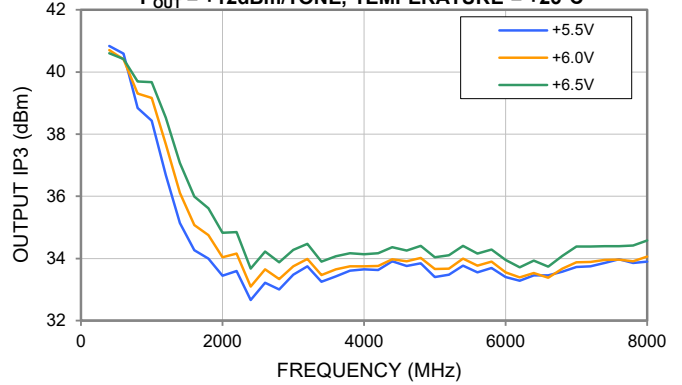



MMIC SURFACE MOUNT

Wideband Amplifier

PMA3-83LP+

Mini-Circuits

50Ω 0.4 to 8 GHz +6 V Supply

TYPICAL PERFORMANCE GRAPHS

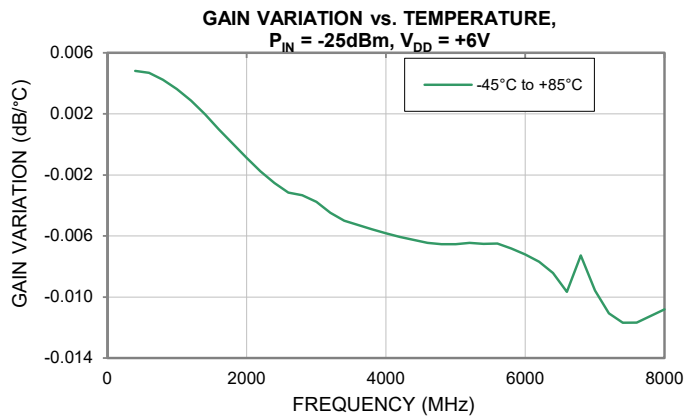
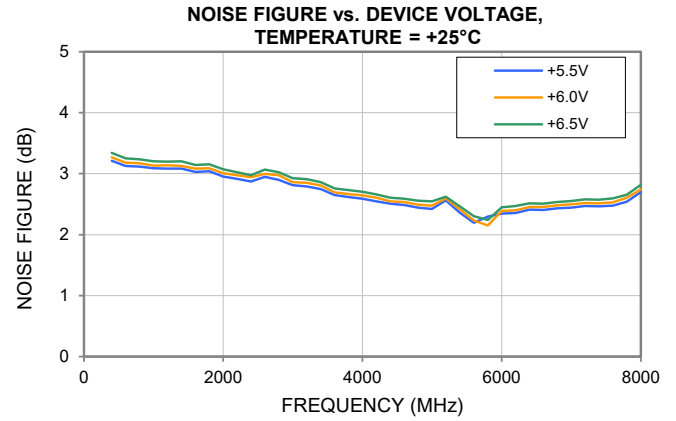
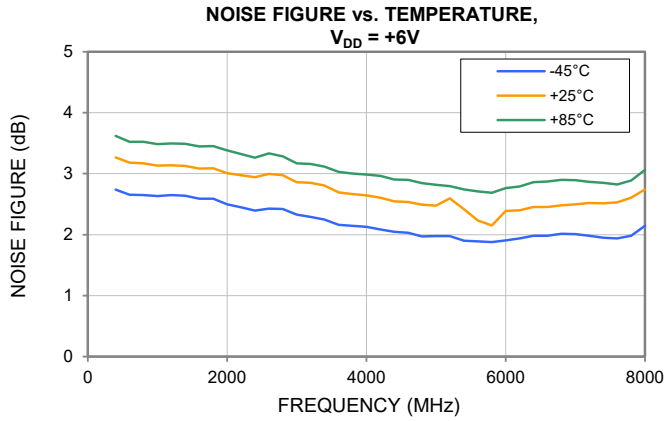



TYPICAL PERFORMANCE GRAPHS

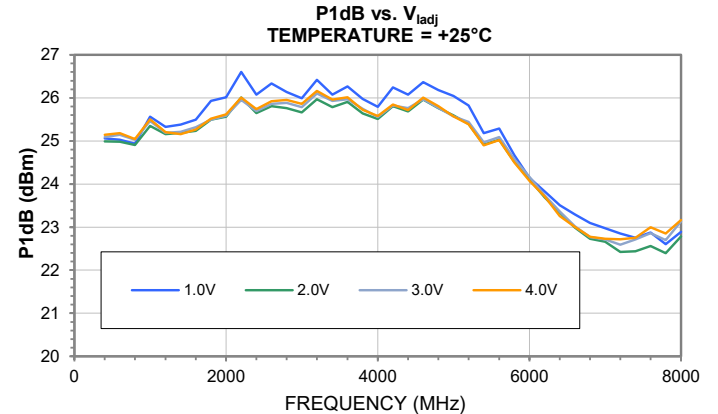
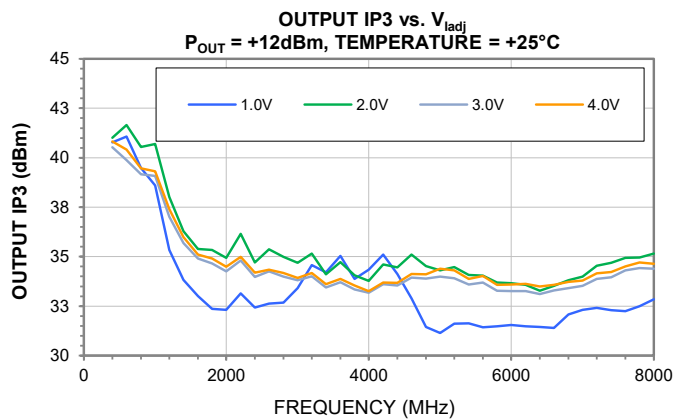
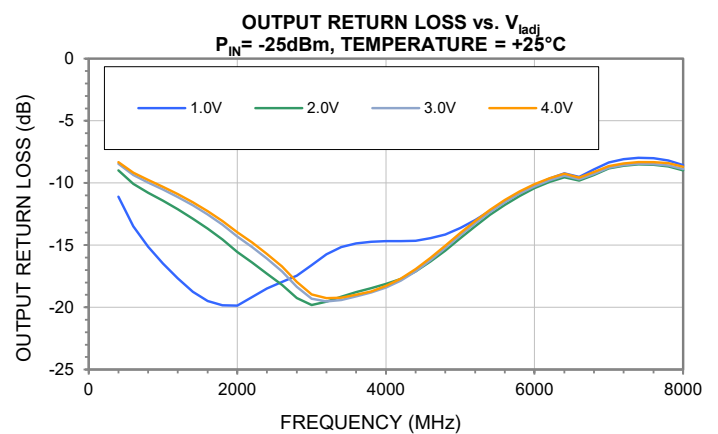
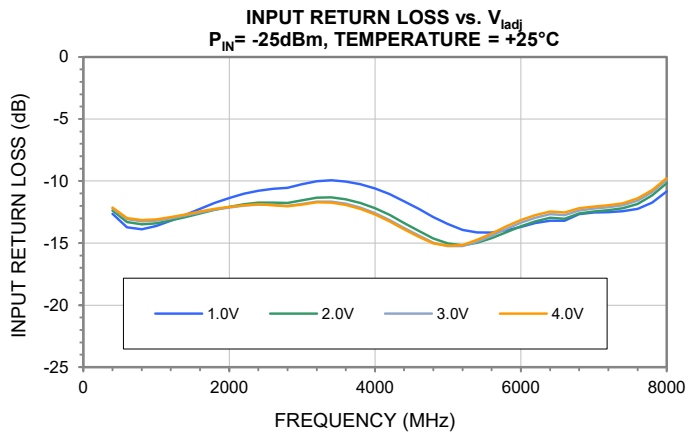
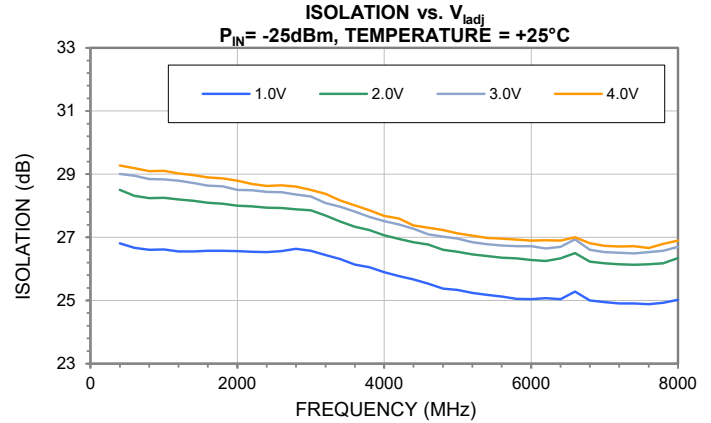
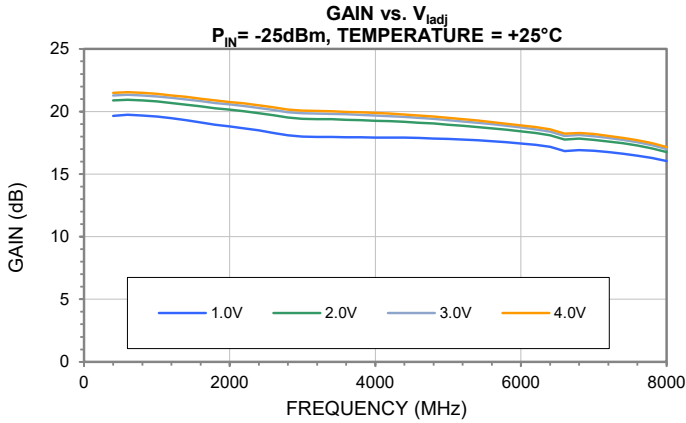



MMIC SURFACE MOUNT

Wideband Amplifier

PMA3-83LP+

Mini-Circuits

50Ω 0.4 to 8 GHz +6 V Supply

TYPICAL PERFORMANCE GRAPHS

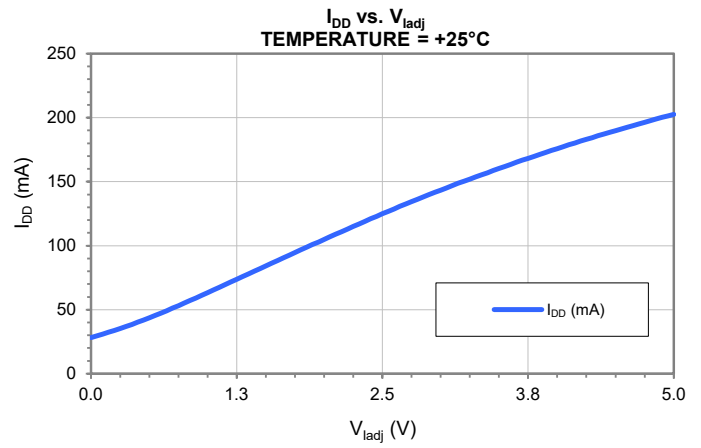
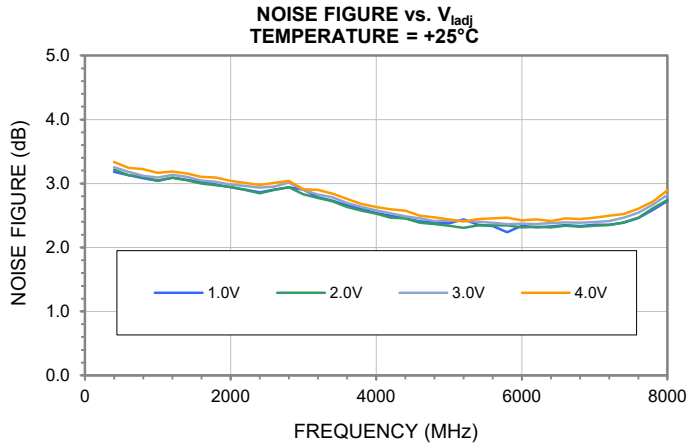



MMIC SURFACE MOUNT

Wideband Amplifier

PMA3-83LP+

Mini-Circuits

50Ω 0.4 to 8 GHz +6 V Supply

ABSOLUTE MAXIMUM RATINGS⁵

Parameter	Ratings
Operating Temperature (ground lead)	-45°C to +85°C
Storage Temperature	-65°C to +150°C
Junction Temperature ⁶	+150°C
Total Power Dissipation	1.4 W
Input Power (CW)	+23 dBm
DC Voltage at V _{DD}	+9 V
DC Voltage at V _{Iadj}	+6 V

5. Permanent damage may occur if any of these limits are exceeded. Maximum ratings are not intended for continuous normal operation.

6. Peak temperature on top of Die.

THERMAL RESISTANCE

Parameter	Ratings
Thermal Resistance (Θ_{JC}) ⁷	46.3°C/W

7. Θ_{JC} = (Hot Spot Temperature on Die - Temperature at Ground Lead)/Dissipated Power

ESD RATING

	Class	Voltage Range	Reference Standard
Human Body Model (HBM)	1A	250V to <500V	ANSI/ESDA/JEDEC JS-001-2017



ESD HANDLING PRECAUTION: This device is designed to be Class 1A for HBM. Static charges may easily produce potentials higher than this with improper handling and can discharge into DUT and damage it. As a preventive measure Industry standard ESD handling precautions should be used at all times to protect the device from ESD damage.

MSL RATING

Moisture Sensitivity: MSL1 in accordance with IPC/JEDEC J-STD-020E/JEDEC J-STD-033C



MMIC SURFACE MOUNT

Wideband Amplifier

PMA3-83LP+

Mini-Circuits

50Ω 0.4 to 8 GHz +6 V Supply

FUNCTIONAL DIAGRAM

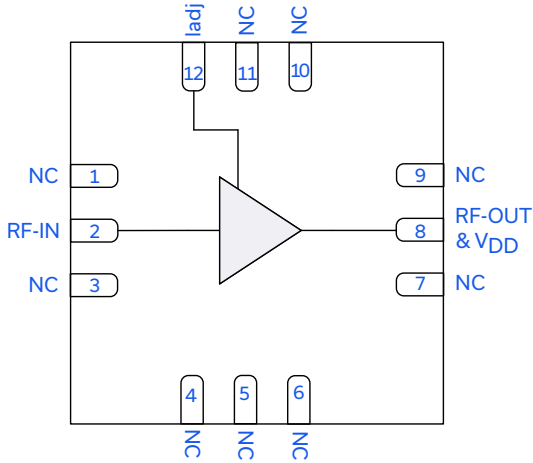

Figure 1. PMA3-83LP+ Functional Diagram

PAD DESCRIPTION

Function	Pad Number	Description (Refer to Figure 2)
RF-IN	2	Connects to RF Input Pad via C1.
RF-OUT & V _{DD}	8	Connects to RF Output Pad via C2 and connects to V _{DD} via L1.
ladj	12	Connects to Current Adjust Pad. Connects to V _{DD} via R1.
NC	1, 3-7, 9-11	Not used internally. Connected to ground on Test Board.
GND	Paddle, Index	Paddle connected to ground on Test Board. (Paddle & Index connected internally.)

CHARACTERIZATION TEST BOARD

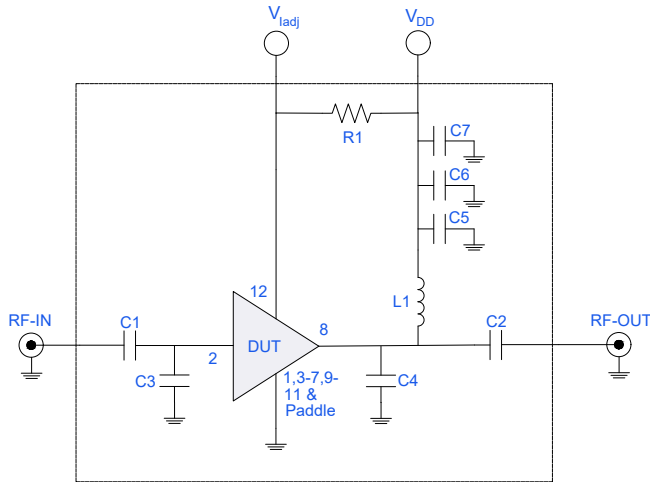

Figure 2. DUT soldered on Mini-Circuits Characterization Test Board: TB-PMA3-83LPC+. If V_{ladj} is used independently of V_{DD} then R1 needs to be removed from the circuit.

Electrical Parameters and Conditions

Gain, Return Loss, Output Power at 1dB Compression (P1dB), Output IP3 (OIP3), and Noise Figure measured using N5242A PNA-X microwave network analyzer.

Conditions:

1. Gain and Return Loss: P_{IN} = -25dBm
2. Output IP3 (OIP3): Two tones, spaced 1MHz apart, +12dBm/tone at output.
3. V_{DD} = +6 V

Component	Vendor	Vendor P/N	Value	Size
C1, C2	Murata	GRM1555C1H101JA01D	100pF	0402
C3	Murata	GJM1555C1HR40WB01D	0.4pF	0402
C4	Murata	GJM1555C1HR10WB01D	0.1pF	0402
C5	Murata	GRM1555C1H100JA01D	10pF	0402
C6	Murata	GRM155C71A105KE11D	1uF	0402
C7	Murata	GRM188D71A106MA73J	10uF	0603
L1	Coilcraft	0603CS-33NXJEW	33nH	0603
R1	KOA Speer	RK73H1ETTP2201F	2.2kΩ	0402



MMIC SURFACE MOUNT

Wideband Amplifier

PMA3-83LP+

Mini-Circuits

50Ω 0.4 to 8 GHz +6 V Supply

CASE STYLE DRAWING

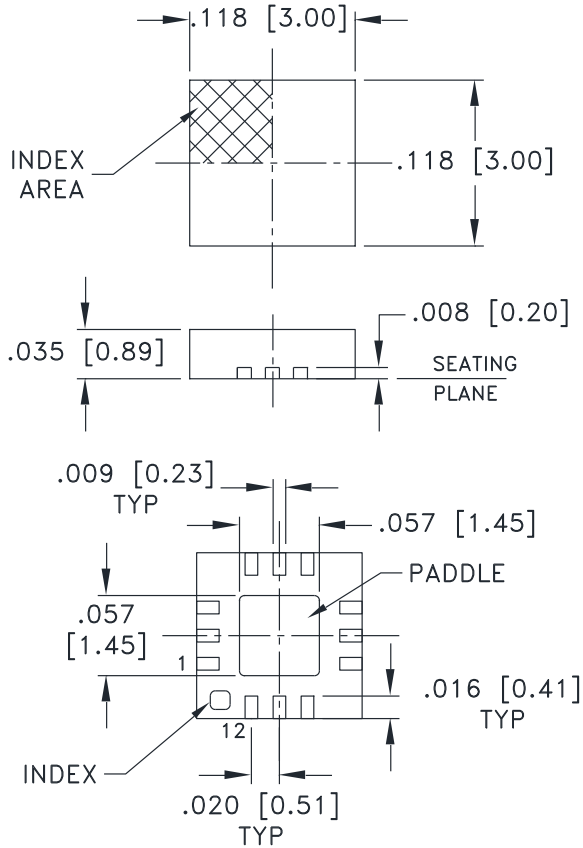

PCB Land Pattern

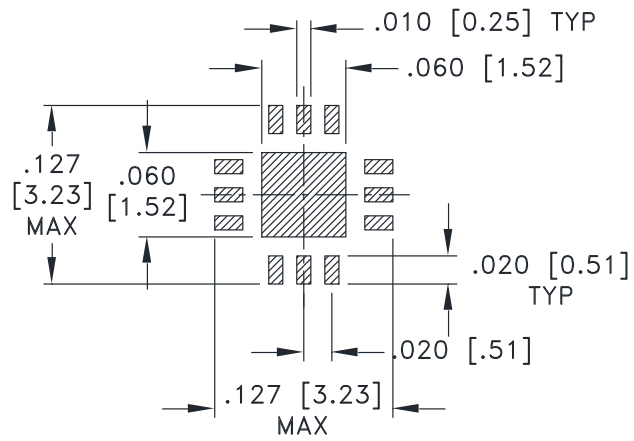

SUGGESTED LAYOUT,
TOLERANCE TO BE WITHIN ±.002

Weight: .02 Grams

Dimensions are in inches [mm]. Tolerances in inches: 2 Pl. ±.01; 3 Pl.±.004 inches

PRODUCT MARKING

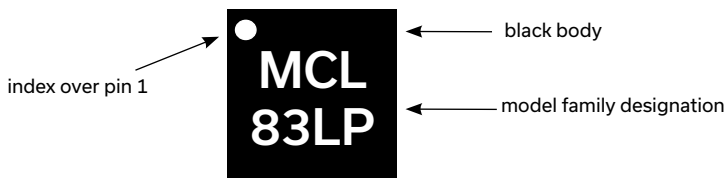

Marking may contain other features or characters for internal lot control



MMIC SURFACE MOUNT

Wideband Amplifier

PMA3-83LP+

Mini-Circuits

50Ω 0.4 to 8 GHz +6 V Supply

ADDITIONAL DETAILED INFORMATION IS AVAILABLE ON OUR DASHBOARD [CLICK HERE](#)

Performance Data	Data
	Graphs
	S-Parameter (S2P Files) Data Set (.zip file)
Case Style	DQ1225 Plastic package, exposed paddle, Lead Finish: Matte-Tin
RoHs Status	Compliant
Tape & Reel	F66
Standard quantities available on reel	7" reels with 20, 50, 100, 200, 500,1K or 2K devices
Suggested Layout for PCB Design	PL-757
Evaluation Board	TB-PMA3-83LPC+
	Gerber File
Environmental Ratings	ENV08T1

NOTES

- A. Performance and quality attributes and conditions not expressly stated in this specification document are intended to be excluded and do not form a part of this specification document.
- B. Electrical specifications and performance data contained in this specification document are based on Mini-Circuit's applicable established test performance criteria and measurement instructions.
- C. The parts covered by this specification document are subject to Mini-Circuits standard limited warranty and terms and conditions (collectively, "Standard Terms"); Purchasers of this part are entitled to the rights and benefits contained therein. For a full statement of the standard terms and the exclusive rights and remedies thereunder, please visit Mini-Circuits' website at www.minicircuits.com/terms/viewterm.html

