

**Harvatek 3.0mm Round LED LAMP****HV-62R2604D-F28**

---

Official Product	HV-62R2604D-F28	Customer Part No.	Data Sheet No.
*	*****	*****	HV-62R2604D-F28
Specifications are subject to change without notice. Data and drawings herein are copyrighted.	Mar.09 2026	Version of 1.0	Page 1/12

## DISCLAIMER

HARVATEK reserves the right to make changes without further notice to any products herein to improve reliability, function or design. HARVATEK does not assume any liability arising out of the application or use of any product or circuit described herein; neither does it convey any license under its patent rights, nor the rights of others.

## LIFE SUPPORT POLICY

HARVATEK's products are not authorized for use as critical components in life support devices or systems without the express written approval of the President of HARVATEK or HARVATEK INTERNATIONAL. As used herein:

1. Life support devices or systems are devices or systems which, (a) are intended for surgical implant into the body, or (b) support or sustain life, and (c) whose failure to perform when properly used in accordance with instructions for use provided in the labeling, can be reasonably expected to result in a significant injury of the user.
2. A critical component in any component of a life support device or system whose failure to perform can be reasonably expected to cause the failure of the life support device or system, or to affect its safety or effectiveness.

---

Official Product	HV-62R2604D-F28	Customer Part No.	Data Sheet No.
*	*****	*****	HV-62R2604D-F28
Specifications are subject to change without notice. Data and drawings herein are copyrighted.	Mar.09 2026	Version of 1.0	Page 2/12

## Compliance and Certification

ISO9002, QS9000 and ISO14001 Certified  
RoHS Compliant



## Orderable Information

**H V - 62 R 2604 D - F28**

Series Name	Color Code	Remark
HV : HARVATEK	62R2604: 3.0mm Round LED LAMP,4.5mm Lens. GaP 622nm Red chip. D : Red Diffused. F28: HARVATEK Part No.	

## Features:

- Stable Color.
- Popular 3.0mm through hole package, 4.5mm lens height.
- Red Diffused lens.

Official Product	HV-62R2604D-F28	Customer Part No.	Data Sheet No.
*	*****	*****	HV-62R2604D-F28
Specifications are subject to change without notice. Data and drawings herein are copyrighted.		Mar.09 2026	Version of 1.0
			Page 3/12

## Package Dimensions:

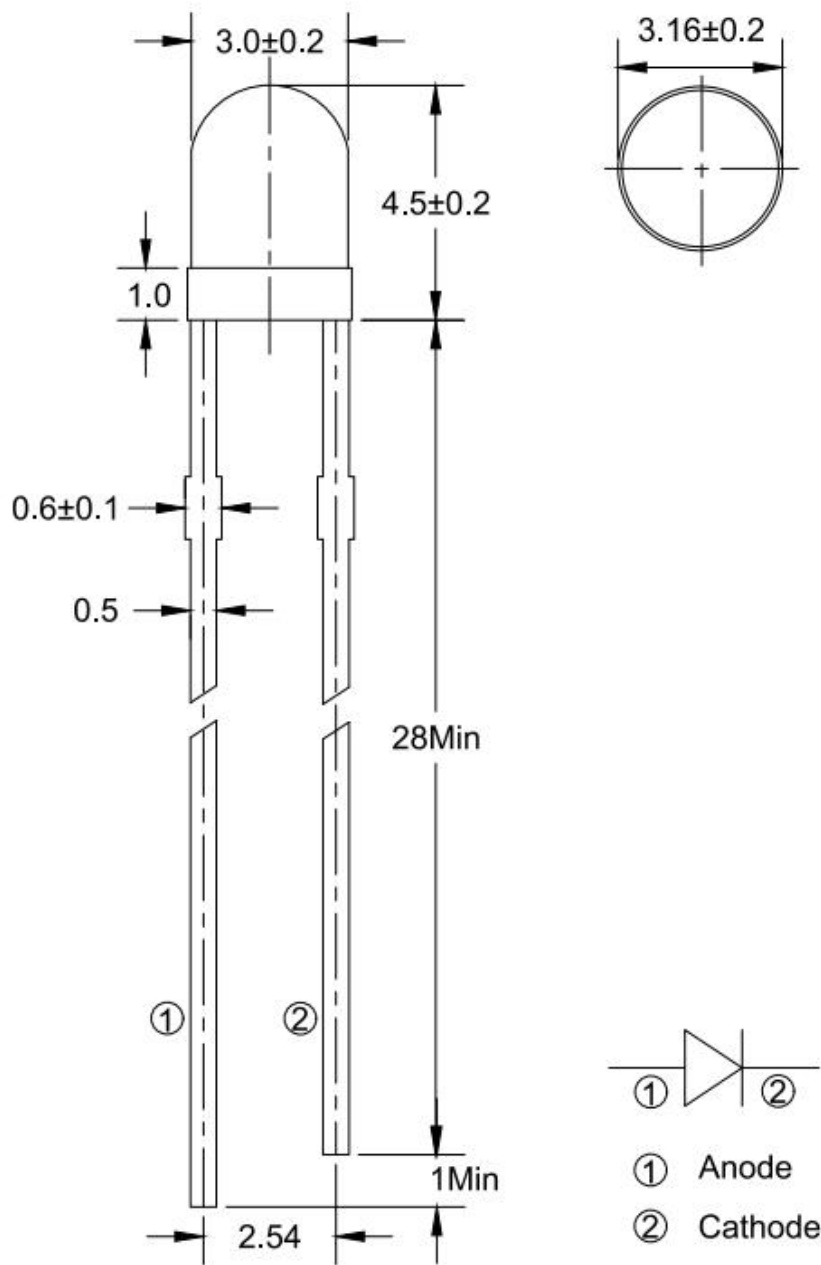

### Notes:

1. All dimensions are millimeters.
2. Tolerance is +/-0.25mm unless otherwise noted.
3. Specifications are subject to change without notice.

Official Product	HV-62R2604D-F28	Customer Part No.	Data Sheet No.
*	*****	*****	HV-62R2604D-F28
Specifications are subject to change without notice. Data and drawings herein are copyrighted.		Mar.09 2026	Version of 1.0
			Page 4/12

## Absolute Maximum Ratings at Ta=25°C

Parameter	Symbol	Rating	Unit
Forward Current	I <sub>F</sub>	30	mA
Operating Temperature	T <sub>opr</sub>	-40to+85	°C
Storage Temperature	T <sub>stg</sub>	-40to+85	°C
Soldering Temperature*1	T <sub>sol</sub>	260	°C
Power Dissipation	P <sub>d</sub>	75	mW
Reverse Voltage	V <sub>R</sub>	5	V
Peak Forward Current*2	I <sub>FP</sub>	75	mA

\*1:Soldering time ≅ 5 seconds. \*2 Pulse Width ≅ 100μs and Duty ≅ 1%.

Official Product	HV-62R2604D-F28	Customer Part No.	Data Sheet No.
*	*****	*****	HV-62R2604D-F28
Specifications are subject to change without notice. Data and drawings herein are copyrighted.		Mar.09 2026	Version of 1.0
			Page 5/12

## Electrical and Optical Characteristic

Parameter	Symbol	Condition	Min	Typ	Max	Unit
Forward Voltage	$V_F$	$I_F=20\text{ mA}$	/	2.0	2.5	V
Reverse Current	$I_R$	$V_R=5\text{ V}$	/	/	10	$\mu\text{A}$
Luminous Intensity	$I_V$	$I_F=20\text{ mA}$	10	25	/	mcd
Viewing Angle	$2\theta_{1/2}$	$I_F=20\text{ mA}$	/	80	/	deg
Dominant Wavelength	$\lambda_d$	$I_F=20\text{ mA}$	/	622	/	nm
Peak Wavelength	$\lambda_p$	$I_F=20\text{ mA}$	/	630	/	nm
Spectrum Radiation Bandwidth	$\Delta\lambda$	$I_F=20\text{ mA}$	/	40	/	nm

### Notes:

$\theta_{1/2}$  is the angle from optical centerline where the luminous intensity is 1/2 the optical centerline value.

Official Product	HV-62R2604D-F28	Customer Part No.	Data Sheet No.
*	*****	*****	HV-62R2604D-F28
Specifications are subject to change without notice. Data and drawings herein are copyrighted.		Mar.09 2026	Version of 1.0
			Page 6/12

**Specifications for Bin Grading:**

Iv (mcd)		
L	10	20
M	16	32
N	25	50
P	40	80

Notes: Luminous intensity: +/-15%.

Official Product	HV-62R2604D-F28	Customer Part No.	Data Sheet No.
*	*****	*****	HV-62R2604D-F28
Specifications are subject to change without notice. Data and drawings herein are copyrighted.		Mar.09 2026	Version of 1.0
			Page 7/12

## Typical Electro-Optical Characteristics Curves

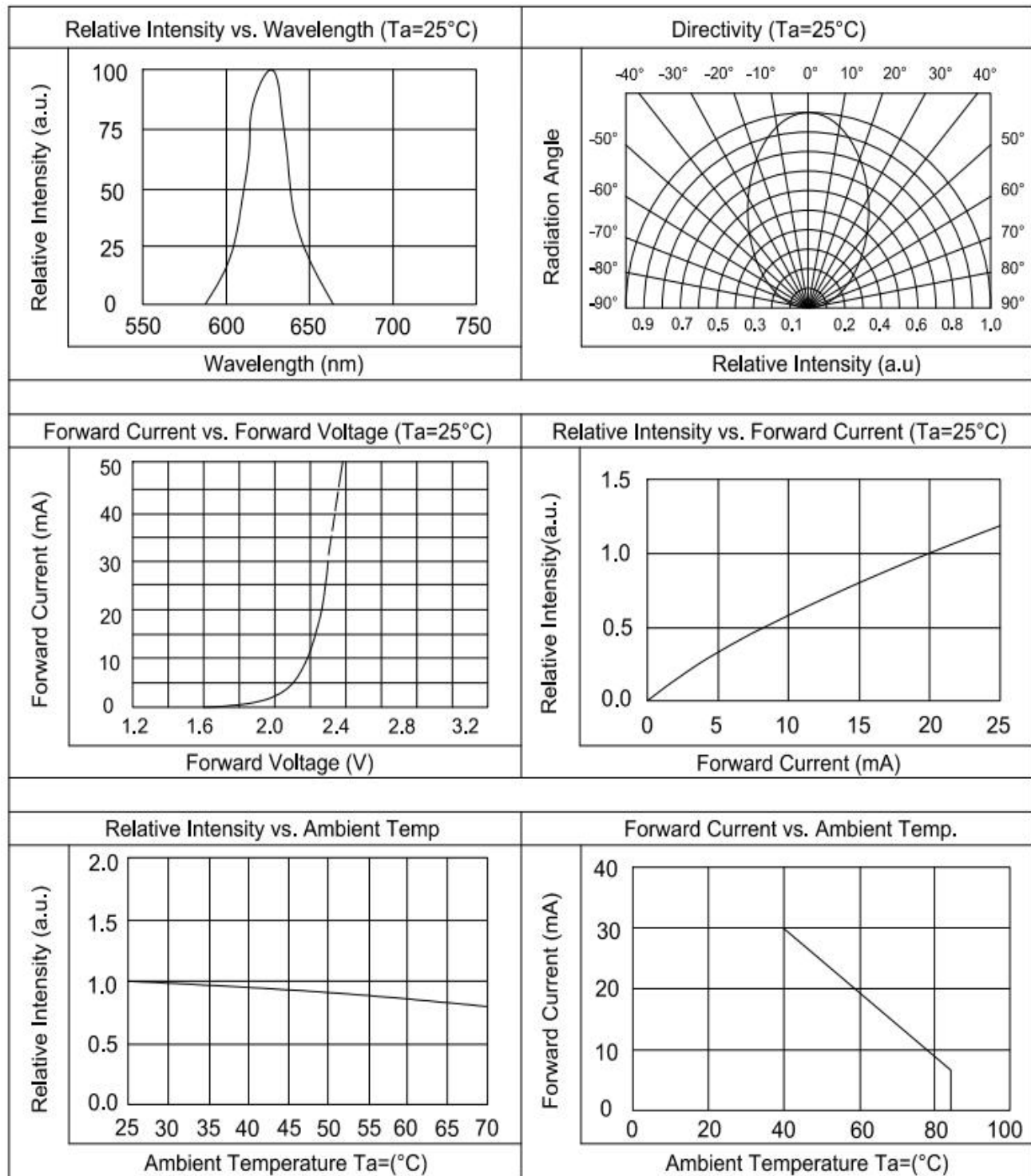

Official Product	HV-62R2604D-F28	Customer Part No.	Data Sheet No.
*	*****	*****	HV-62R2604D-F28
Specifications are subject to change without notice. Data and drawings herein are copyrighted.		Mar.09 2026	Version of 1.0
			Page 8/12

## Soldering condition

1. Careful attention should be paid during soldering. When soldering, leave more than 2mm from solder joint to Led, and soldering beyond the base of the tie bar is recommended.
2. Avoiding applying any stress to the lead frame while the LED are at high temperature particularly when soldering.
3. Dip and hand soldering should not be done more than one time.
4. After soldering the LED, the epoxy bulb should be protected from mechanical shock or vibration until the LED return to room temperature.
5. A rapid-rate process is not recommended for cooling the LED down from the peak temperature.
6. Although the recommended soldering conditions are specified in the above table, dip or hand soldering at the lowest possible temperature is desirable for the LED.
7. Wave soldering parameter must be set and maintain according to recommended temperature and dwell time in the solder wave.

### • Recommended soldering conditions

Hand Soldering		Wave Soldering	
Temp. at tip of iron	300°C Max. (30W Max.)	Preheat temp.	100°C Max. (60 sec Max.)
Soldering time	3 sec Max.	Bath temp. & time	260°C Max., 5 sec Max
Distance	2mm Min.(From solder joint to Led)	Distance	2mm Min. (From solder joint to Led)

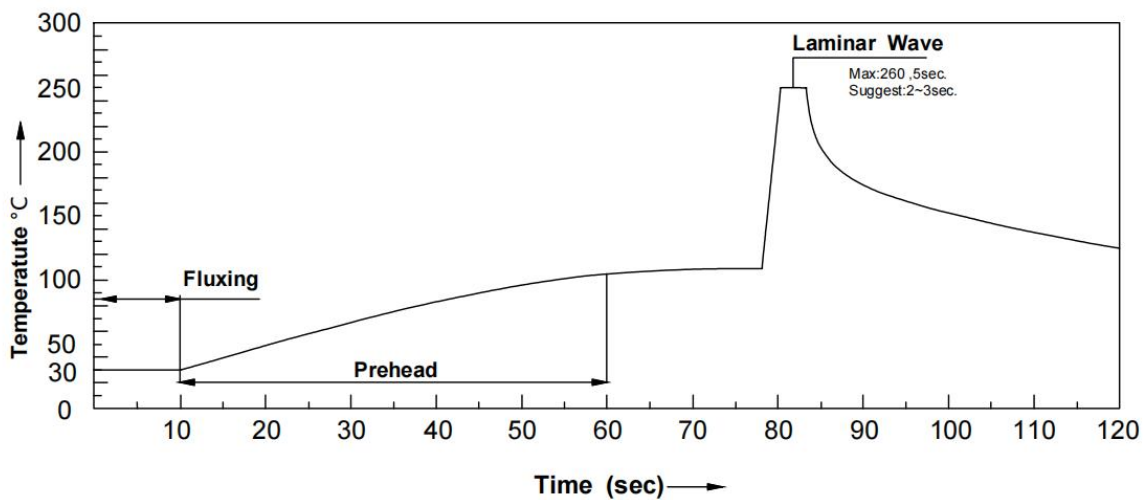

Official Product	HV-62R2604D-F28	Customer Part No.	Data Sheet No.
*	*****	*****	HV-62R2604D-F28
Specifications are subject to change without notice. Data and drawings herein are copyrighted.		Mar.09 2026	Version of 1.0
			Page 9/12

## Reliability test items and conditions:

The reliability of products shall be satisfied with items listed below.

Confidence level: 97%.

LTPD:3%.

No	Item	Test Conditions	Test Hours/Cycle	Sample Size	Failure Judgment Criteria	Ac/Er
1	Solder Heat	TEMP:260°C±5°C	10 SEC	76 PCS	$I_v \leq I_{vt} * 0.5$ or $V_f \geq U$ or $V_f \leq L$	0/1
2	Temperature Cycle	H:+100°C 15min ∫ 5min L:-40°C 15min	300 CYCLES	76 PCS		0/1
3	Thermal Shock	H:+100°C 5min ∫ 10sec L:-10°C 5min	300 CYCLES	76 PCS		0/1
4	High Temperature Storage	TEMP:100°C	1000 HRS	76 PCS		0/1
5	Low Temperature Storage	TEMP:-40°C	1000 HRS	76 PCS		0/1
6	DC Operating Life	TEMP:25°C IF=20mA	1000 HRS	76 PCS		0/1
7	High Temperature / High Humidity	85°C/85%RH	1000 HRS	76 PCS		0/1

Note:  $I_{vt}$ : To test  $I_v$  value of the chip before the reliability test.

$I_v$ : The test value of the chip that has completed the reliability test.





U: Upper Specification Limit.

L: Lower Specification Limit.

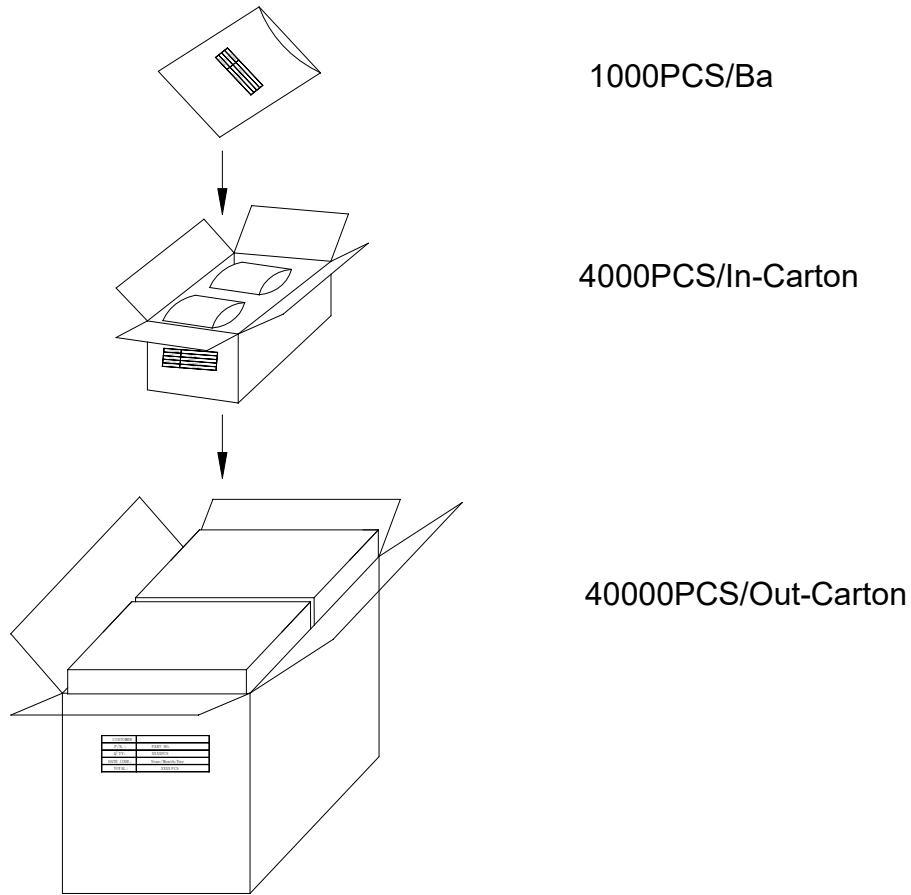
Official Product	HV-62R2604D-F28	Customer Part No.	Data Sheet No.
*	*****	*****	HV-62R2604D-F28
Specifications are subject to change without notice. Data and drawings herein are copyrighted.		Mar.09 2026	Version of 1.0
			Page 10/12

## Packing Specification:



	<b>HARVATEK</b>	
<b>CPN:</b>		<b>RoHs</b>
<b>P/N:</b>		
	<b>HV-62R2604D-F28</b>	
<b>QTY:</b>		<b>CAT:</b>
		<b>HUE:</b>
<b>LOT NO:</b>		<b>REF:</b>

Official Product	HV-62R2604D-F28	Customer Part No.	Data Sheet No.
*	*****	*****	HV-62R2604D-F28
Specifications are subject to change without notice. Data and drawings herein are copyrighted.		Mar.09 2026	Version of 1.0
			Page 11/12

