

ACS37002LMC

400 kHz, High Accuracy Current Sensor with Pin-Selectable Gains and Adjustable Overcurrent Fast Fault in SOICW-16 Package

FEATURES AND BENEFITS (continued)

- Enabling measurement ranges from 33 to 180 A in both unidirectional and bidirectional modes
- UL60950-1 (ed. 2) and UL 62368 (ed. 1) certification, highly isolated compact SOICW-16 surface mount package (MC)
 - 5 kV_{RMS} rated isolation voltage
 - 1144 V_{RMS} / 1618 V_{DC} basic isolation voltages
 - 572 V_{RMS} / 809 V_{DC} reinforced isolation voltages
- Wide operating temperature, -40°C to 150°C
- AEC-Q100 qualified



SELECTION GUIDE

Part Number	Current Sensing Range, I _{PR} (A)	Sensitivity [1] (mV/A)	Nominal V _{CC} (V)	Optimized Temp. Range T _A (°C)	Packing
ACS37002LMCATR-050B5	±33.3, ±40, ±50, ±66.7	60, 50, 40, 30	5	-40 to 150	1000 pieces per 13-inch reel
ACS37002LMCATR-050U5	33.3, 40, 50, 66.7	120, 100, 80, 60			
ACS37002LMCATR-066B5	±66.7, ±80, ±100, ±133.3	30, 25, 20, 15			
ACS37002LMCATR-090B5	±90, ±108, ±135, ±180	22.2, 18.5, 14.8, 11.1			
ACS37002LMCATR-050B3	±33.3, ±40, ±50, ±66.7	39.6, 33, 26.4, 19.8	3.3		
ACS37002LMCATR-066B3	±66.7, ±80, ±100, ±133.3	19.8, 16.5, 13.2, 9.9			
ACS37002LMCATR-066U3	66.7, 80, 100, 133.3	39.6, 33, 26.4, 19.8			
ACS37002LMCATR-090B3	±90, ±108, ±135, ±180	14.7, 12.2, 9.8, 7.3			

[1] Refer to the part specific performance characteristics sections for Gain_Sel configuration.

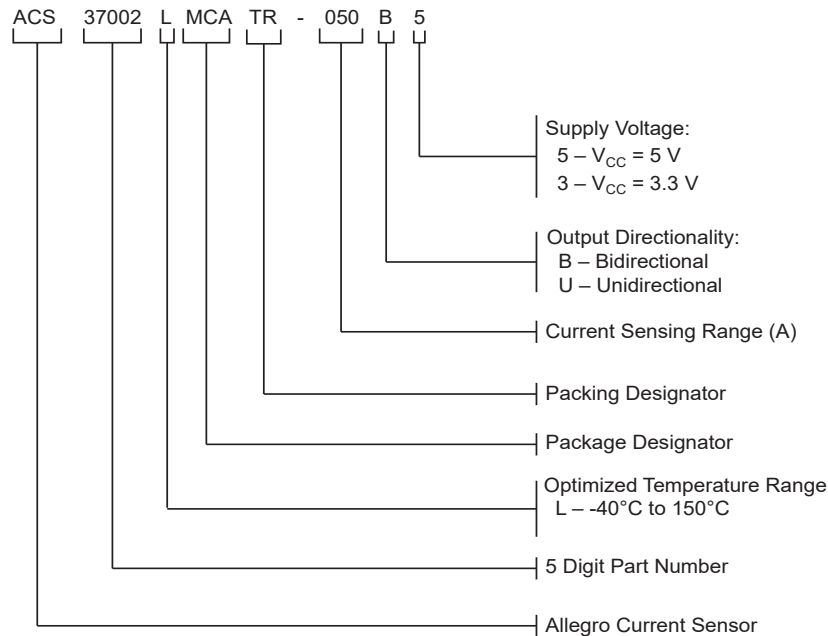

Table of Contents

Features and Benefits.....	1	Sensitivity (Sens).....	22
Description.....	1	Sensitivity Error (E_{sens}).....	22
Packages.....	1	Gain Selection Pins.....	22
Selection Guide.....	2	Full Scale (FS).....	22
Absolute Maximum Ratings.....	4	Nonlinearity (E_{LIN}).....	22
Isolation Characteristics.....	4	Total Output Error (E_{TOT}).....	23
Pinout Diagram and Terminal List.....	5	Power Supply Offset Error (V_{PS}).....	23
Functional Block Diagram.....	6	Offset Power Supply Rejection Ratio ($PSRR_O$).....	23
Common Electrical Characteristics.....	7	Power Supply Sensitivity Error (E_{PS}).....	23
Performance Characteristics.....	10	Sensitivity Power Supply Rejection Ratio ($PSRR_S$).....	23
Functional Description.....	18	Fault Behavior.....	24
Power-On Reset Operation.....	18	Overcurrent Fault (OCF).....	24
Power-On.....	18	Overcurrent Fault Operating Range/Point (I_{OCF-OR} , I_{OCF-OP}).....	24
Power-Off.....	18	Overcurrent Fault Hysteresis ($I_{OCF-Hyst}$).....	24
Power-On Timing.....	18	Voltage Overcurrent Pin (VOC).....	24
Power-On Reset (POR).....	18	Overcurrent Fault Error (E_{OCF}).....	25
Power-On Delay (t_{POD}).....	18	Overcurrent Fault Response Time (t_{OCF}).....	25
Overvoltage and Undervoltage Detection.....	18	Overcurrent Fault Reaction Time (t_{OCF-R}).....	25
Overvoltage Detection Voltage Thresholds ($V_{OVD(H/L)}$).....	18	Overcurrent Fault Mask Time ($t_{OCF-MASK}$).....	25
Overvoltage Detection Hysteresis ($V_{OVD(Hys)}$).....	18	Overcurrent Fault Hold Time ($t_{OCF-HOLD}$).....	25
Overvoltage Enable and Disable Time ($t_{OVD(E/D)}$).....	18	Overcurrent Fault Persist.....	25
Supply Zener Clamp Voltages.....	18	OCF Disable.....	25
Absolute Maximum Ratings.....	20	Dynamic Response Parameters.....	26
Forward and Reverse Supply Voltage.....	20	Propagation Time (t_{PD}).....	26
Forward and Reverse Output Voltage.....	20	Rise Time (t_r).....	26
Forward and Reverse Input Voltage.....	20	Response Time ($t_{RESPONSE}$).....	26
Output Source and Sink Current.....	20	Overshoot.....	26
Ambient Temperature (T_A).....	20	Settling Time.....	26
Definitions of Operating and Performance Characteristics.....	21	Temperature Compensation.....	26
Zero Current Voltage Output ($V_{IOUT(Q)}$, QVO).....	21	Temperature Compensation Update Rate.....	26
QVO Temperature Drift (V_{QE}).....	21	Application and Theory.....	27
Reference Voltage (V_{REF}).....	21	Application Circuits.....	27
Reference Voltage Temperature Drift (VRE).....	21	Theory and Functionality – VOC and OCF.....	28
Offset Voltage (VOE).....	21	VOC Driven by Non-Inverting Buffered VREF.....	28
Output Saturation Voltage ($V_{SAT(HIGH/LOW)}$).....	21	Power Supply Decoupling Capacitor	
Output Voltage Operating Range (V_{OOR}).....	21	and Output Capacitive Loads.....	28
		Dynamically Change Gain in a System.....	29
		Package Outline Drawings.....	31
		MC Package.....	31

ABSOLUTE MAXIMUM RATINGS

Characteristic	Symbol	Notes	Rating	Unit
Forward Supply Voltage	V_{CC}		6.5	V
Reverse Supply Voltage	V_{RCC}		-0.5	V
Forward Output Voltage	V_{OUT}	Applies to V_{IOUT} , V_{OCF} , and V_{REF}	$(V_{CC} + 0.7) \leq 6.5$	V
Reverse Output Voltage	V_{ROUT}	Applies to V_{IOUT} , V_{OCF} , and V_{REF}	-0.5	V
Forward Input Voltage	V_{IN}	Applies to GAIN_SEL_0, GAIN_SEL_1, and VOC	$(V_{CC} + 0.7) \leq 6.5$	V
Reverse Input Voltage	V_{RIN}	Applies to GAIN_SEL_0, GAIN_SEL_1, and VOC	-0.5	V
Operating Ambient Temperature	T_A		-40 to 150	°C
Storage Temperature	T_{stg}		-65 to 165	°C
Maximum Junction Temperature	$T_{J(max)}$		165	°C

THERMAL CHARACTERISTICS

Characteristic	Symbol	Notes	Value	Unit
Package Thermal Resistance (Junction to Ambient)	$R_{\theta JA}$	Mounted on the standard MC current sensor evaluation board (ACSEVB-MC16)	19	°C/W
Package Thermal Metric (Junction to Top)	Ψ_{JT}		2.4	°C/W
Package Thermal Resistance (Junction to Case)	$R_{\theta JC}$	Simulated per the methods in JESD51-1	15	°C/W
Package Thermal Resistance (Junction to Board)	$R_{\theta JB}$	Simulated per the methods in JESD51-8	7.3	°C/W

ISOLATION AND PACKAGE CHARACTERISTICS

Characteristic	Symbol	Notes	Rating	Unit
Withstand Voltage [1][2]	V_{ISO}	Agency rated for 60 seconds per UL 62368-1 (edition 3)	5000	V_{RMS}
Working Voltage for Basic Isolation [2]	V_{WVBI}	Maximum approved working voltage for basic (single) isolation according to UL 62368-1 (edition 3)	1618	V_{PK} or V_{DC}
			1144	V_{RMS}
Working Voltage for Reinforced Isolation [2]	V_{WVRI}	Maximum approved working voltage for reinforced isolation according to UL 62368-1 (edition 3)	809	V_{PK} or V_{DC}
			572	V_{RMS}
Surge Voltage	V_{SURGE}	1.2 / 50 μs waveform, tested in dielectric fluid to determine intrinsic surge immunity of isolation barrier	13000	V_{PK}
Impulse Voltage	$V_{IMPULSE}$	1.2 / 50 μs waveform, tested in air	7071	V_{PK}
Clearance	D_{CL}	Minimum distance through air from IP leads to signal leads	8.7	mm
Creepage	D_{CR}	Minimum distance along package body from IP leads to signal leads	8.7	mm
Distance Through Insulation	DTI	Minimum internal distance through insulation	110	μm
Comparative Track Index	CTI	Material Group II	400 to 599	V

[1] Production-tested in accordance with UL 62368-1 (edition 3).

[2] Certification pending.

PINOUT DIAGRAM AND TERMINAL LIST TABLE

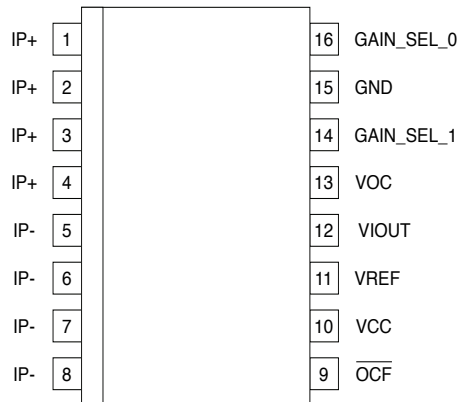

Figure 2: MC Pinout Diagram

Terminal List Table

Number	Name	Description
1, 2, 3, 4	IP+	Terminals for current being sensed; fused internally
5, 6, 7, 8	IP-	Terminals for current being sensed; fused internally
9	OCF	Overcurrent fault, open-drain
10	VCC	Device power supply terminal
11	VREF	Zero current voltage reference
12	VIOUT	Analog output representing the current flowing through I _p
13	VOC	Overcurrent fault operation point input
14	GAIN_SEL_1	Gain selection bit 1
15	GND	Device ground terminal
16	GAIN_SEL_0	Gain selection bit 0

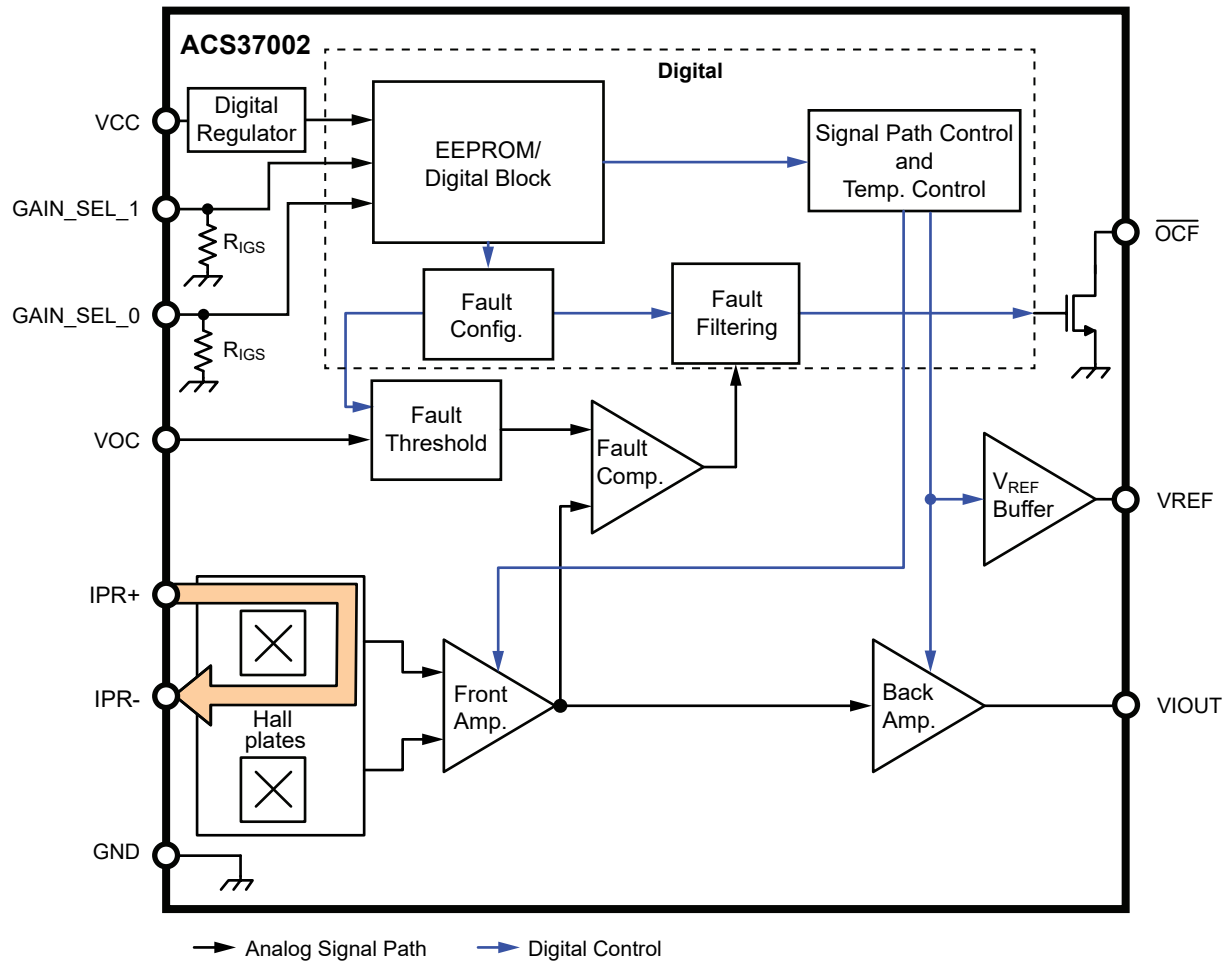

Figure 3: Functional Block Diagram

COMMON ELECTRICAL CHARACTERISTICS: Valid through full operating temperature range, $T_A = -40^\circ\text{C}$ to 150°C , $C_{\text{BYPASS}} = 0.1 \mu\text{F}$, and $V_{\text{CC}} = 5 \text{ V}$ or 3.3 V , unless otherwise specified

Characteristic	Symbol	Test Conditions	Min.	Typ.	Max.	Units
Supply Voltage	V_{CC}	5 V devices only	4.5	5	5.5	V
		3.3 V devices only	3.15	3.3	3.6	V
Supply Current	I_{CC}	No load on VIOOUT or VREF; $V_{\text{CC}} = 5 \text{ V}$	–	13	18	mA
		No load on VIOOUT or VREF; $V_{\text{CC}} = 3.3 \text{ V}$	–	12	15	mA
Supply Bypass Capacitor	C_{BYPASS}	VCC to GND recommended	0.1	–	–	μF
Output Resistive Load	R_{L}	VIOOUT to GND, VIOOUT to VCC	10	–	–	k Ω
Output Capacitive Load	C_{L}	VIOOUT to GND	–	1	6	nF
Reference Resistive Load	R_{VREF}	VREF to GND (recommended to supply VOC); VREF to VCC	10	62.7	–	k Ω
Reference Capacitive Load	C_{VREF}	VREF to GND	–	–	6	nF
Fault Pull-Up Resistance	R_{PU}		4.7	–	500	k Ω
Primary Conductor Resistance	R_{IP}	$T_A = 25^\circ\text{C}$	–	0.27	–	m Ω
Primary Conductor Inductance	L_{IP}	$T_A = 25^\circ\text{C}$	–	4.45	–	nH
Output Buffer Resistance	R_{OUT}	Internal output buffer resistance on VIOOUT and VREF	–	4	–	Ω
Power-On Reset Voltage	$V_{\text{POR(H)}}$	V_{CC} rising [1]	2.6	2.9	3.1	V
	$V_{\text{POR(L)}}$	V_{CC} falling [1]	2.2	2.5	2.8	V
POR Hysteresis	$V_{\text{POR(HYS)}}$		250	–	–	mV
Power-On Time	t_{POD}	Time from V_{CC} rising $\geq V_{\text{POR(H)}}$ after a POR event until power-on; VREF, OCF, VIOOUT	100	–	–	μs
Overvoltage Detection (OVD) Threshold	$V_{\text{OVD(H)}}$	V_{CC} rising [1]	6.1	6.4	6.8	V
	$V_{\text{OVD(L)}}$	V_{CC} falling [1]	5.6	5.8	6.1	V
Overvoltage Detection Hysteresis	$V_{\text{OVD(HYS)}}$		–	660	–	mV
OVD Delay Time	$t_{\text{dOVD(E)}}$	Time from V_{CC} rising $\geq V_{\text{OVD(EN)}}$ until OVD asserts	60	82	120	μs
	$t_{\text{dOVD(D)}}$	Time from V_{CC} falling $\leq V_{\text{OVD(DIS)}}$ until OVD clears	–	7	–	μs

Continued on the next page...

COMMON PERFORMANCE CHARACTERISTICS (VIOUT): Valid through full operating temperature range, $T_A = -40^\circ\text{C}$ to 150°C , $C_{\text{BYPASS}} = 0.1 \mu\text{F}$, and $V_{\text{CC}} = 5 \text{ V}$ or 3.3 V , unless otherwise specified

Characteristic	Symbol	Test Conditions	Min.	Typ.	Max.	Units
OUTPUT SIGNAL CHARACTERISTICS (V_{IOUT})						
Saturation Voltage	$V_{\text{SAT(H)}}$	$R_L = 10 \text{ k}\Omega$ to GND	$V_{\text{CC}} - 0.25$	–	–	V
	$V_{\text{SAT(L)}}$	$R_L = 10 \text{ k}\Omega$ to V_{CC}	–	–	0.15	V
Output Operating Range	V_{OOR}	5 V linear operating range	0.5	–	4.5	V
		3.3 V linear operating range	0.3	–	3.0	V
Output Current Limit	$I_{\text{OUT(src)}}$	V_{IOUT} shorted to GND	–	25	–	mA
	$I_{\text{OUT(snk)}}$	V_{IOUT} shorted to V_{CC}	–	25	–	mA
Internal Bandwidth	BW	Small signal –3 dB, $C_L = 5.7 \text{ nF}$	–	400	–	kHz
Rise Time	t_r	$T_A = 25^\circ\text{C}$, $C_L = 5.7 \text{ nF}$, 10%-90% of 1 V output swing	–	0.7	2.5	μs
Response Time	t_{RESPONSE}	$T_A = 25^\circ\text{C}$, $C_L = 5.7 \text{ nF}$, 90% input to 90% of 1 V output swing	–	1.1	2.5	μs
Propagation Delay	t_{PD}	$T_A = 25^\circ\text{C}$, $C_L = 5.7 \text{ nF}$, 20% input to 20% of 1 V output swing	–	0.7	2	μs
Noise Density	I_{ND}	Input-referenced noise density; $T_A = 25^\circ\text{C}$, $C_L = 5.7 \text{ nF}$; $V_{\text{CC}} = 5 \text{ V}$	–	350	–	$\mu\text{A}/\sqrt{\text{Hz}}$
		Input-referenced noise density; $T_A = 25^\circ\text{C}$, $C_L = 5.7 \text{ nF}$; $V_{\text{CC}} = 3.3 \text{ V}$	–	450	–	$\mu\text{A}/\sqrt{\text{Hz}}$
Noise	I_{N}	Input-referenced noise at 400 kHz; $T_A = 25^\circ\text{C}$, $C_L = 5.7 \text{ nF}$; $V_{\text{CC}} = 5 \text{ V}$	–	277	–	mA_{RMS}
		Input-referenced noise at 400 kHz; $T_A = 25^\circ\text{C}$, $C_L = 5.7 \text{ nF}$; $V_{\text{CC}} = 3.3 \text{ V}$	–	357	–	mA_{RMS}
Nonlinearity	E_{LIN}		–	± 0.75	–	%
Power Supply Offset Error	$V_{\text{OE(PS)}}$	3.3 V variant, bidirectional; $V_{\text{CC}} @ 3.15 \text{ V}$ or 3.45 V	–10	± 1	10	mV
		5 V variant, bidirectional; $V_{\text{CC}} @ 4.5 \text{ V}$ or 5.5 V	–10	± 1	10	mV
		3.3 V variant, unidirectional; $V_{\text{CC}} @ 3.15 \text{ V}$ or 3.45 V	–18	± 1	18	mV
		5 V variant, unidirectional; $V_{\text{CC}} @ 4.5 \text{ V}$ or 5.5 V	–18	± 1	18	mV
Power Supply Sensitivity Error	$E_{\text{SENS(PS)}}$	3.3 V variant, $V_{\text{CC}} @ 3.15 \text{ V}$ or 3.45 V	–1.5	± 0.3	1.5	%
		5 V variant, $V_{\text{CC}} @ 4.5 \text{ V}$ or 5.5 V	–1.5	± 0.3	1.5	%
Power Supply Rejection Ratio Offset	PSRR_O	DC to 1 kHz, 100 mV pk-pk ripple around $V_{\text{CC}} = V_{\text{CC(typ)}}$, $I_P = 0 \text{ A}$, change in V_{OE}	–	–40	–	dB
		1 to 100 kHz, 100 mV pk-pk ripple around $V_{\text{CC}} = V_{\text{CC(typ)}}$, $I_P = 0 \text{ A}$, change in V_{OE}	–	–30	–	dB
Power Supply Rejection Ratio Sens	PSRR_S	DC to 1 kHz, 100 mV pk-pk ripple around $V_{\text{CC}} = V_{\text{CC(typ)}}$, $I_P = I_{\text{PR(MAX)}}$, change in Sens	–	–15	–	dB
		1 to 100 kHz, 100 mV pk-pk ripple around $V_{\text{CC}} = V_{\text{CC(typ)}}$, $I_P = I_{\text{PR(MAX)}}$, change in Sens	–	–6	–	dB
Common-Mode Field Rejection	CMFR	Input-referred error due to common-mode field	–	4	–	mA/G

Continued on the next page...

COMMON PERFORMANCE CHARACTERISTICS (VREF, FAULT, GAIN_SEL): Valid through full operating temperature range, $T_A = -40^{\circ}\text{C}$ to 150°C , $C_{\text{BYPASS}} = 0.1 \mu\text{F}$, and $V_{\text{CC}} = 5 \text{ V}$ or 3.3 V , unless otherwise specified

Characteristic	Symbol	Test Conditions	Min.	Typ.	Max.	Units
REFERENCE OUTPUT CHARACTERISTICS (VREF)						
Zero Current Reference Voltage	V_{REF}	Bidirectional; $V_{\text{CC}} = 5 \text{ V}$	2.49	2.5	2.51	V
		Bidirectional; $V_{\text{CC}} = 3.3 \text{ V}$	1.64	1.65	1.66	V
		Unidirectional; $V_{\text{CC}} = 5 \text{ V}$	0.49	0.5	0.51	V
		Unidirectional; $V_{\text{CC}} = 3.3 \text{ V}$	0.32	0.33	0.34	V
Reference Source Current Limit	$I_{\text{REF(src)}}$	Maximum current V_{REF} can passively source	–	25	–	mA
	$I_{\text{REF(snk)}}$	Maximum current V_{REF} can passively sink	–	–25	–	mA
OVERCURRENT FAULT CHARACTERISTICS (OCF)						
OCF On Voltage	$V_{\text{FAULT-ON}}$	$R_{\text{PU}} = 4.7 \text{ k}\Omega$, under fault condition	–	0.07	0.4	V
OCF Sink Current [3]	$I_{\text{OCF(snk)}}$	No Fault	–	100	–	nA
		Fault Asserted	0.01	–	1.1	mA
VOC Operating Voltage Range	V_{VOC}	$V_{\text{CC}} = 5 \text{ V}$	0.5	–	2	V
		$V_{\text{CC}} = 3.3 \text{ V}$	0.33	–	1.32	V
Fault Error	E_{OCF}		–10	± 3	10	% $I_{\text{OCF-OP}}$
OCF Hysteresis	$I_{\text{OCF(HYS)}}$	$V_{\text{CC}} = 5 \text{ V}$	–	6	–	%FS
		$V_{\text{CC}} = 3.3 \text{ V}$	–	9	–	%FS
OCF Response Time [3]	t_{OCF}	Time from $I_{\text{OCF-OP}}$ with a $1.2 \times I_{\text{OCF-OP}}$ until fault asserts	–	1	1.5	μs
OCF Reaction Time [3]	$t_{\text{OCF-R}}$	Time from $I_{\text{OCF-OP}} - I_{\text{OCF(HYS)}}$, until fault releases	–	0.75	1	μs
OCF Mask [2][3]	$t_{\text{OCF-MASK}}$	Time $I_{\text{OCF-OP}}$ must be present after $t_{\text{OCF-R}}$ for fault assertion	0	0	3	μs
OCF Hold Time [2][3]	$t_{\text{OCF-HOLD}}$	Minimum duration of FAULT assertion	0	0	5	ms
GAIN SELECTION PIN CHARACTERISTICS (GAIN_SEL_0, GAIN_SEL_1)						
Gain Select Internal Resistor	R_{GSint}		–	1	–	$\text{M}\Omega$
GAIN_SEL Logic Input Voltage	$V_{\text{H(SEL)}}$	$V_{\text{CC}} = 5 \text{ V}$	3.75	–	–	V
		$V_{\text{CC}} = 3.3 \text{ V}$	2.5	–	–	V
	$V_{\text{L(SEL)}}$	$V_{\text{CC}} = 5 \text{ V}$	–	–	0.5	V
		$V_{\text{CC}} = 3.3 \text{ V}$	–	–	0.4	V
Leakage Current [3]	$I_{\text{SEL(snk)}}$		–	–	10	μA

[1] V_{CC} rate +1 V/ms, for best accuracy.

[2] Typical value is factory default.

[3] Guaranteed by design and bench validated.

ACS37002LMCATR-050B5

ACS37002LMCATR-050B5 Gain_Sel Pin Performance Key

				Selection Identifier
Parameter (Units)	Gain_Sel_1 (Boolean)	Gain_Sel_0 (Boolean)	Sens (mV/A)	Max I _P (A)
Type	Digital Input	Digital Input	Calculation	Bidirectional
Selection Combination	0	0	40	50
	0	1	50	40
	1	0	60	33.3
	1	1	30	66.7

ACS37002LMCATR-050B5 PERFORMANCE CHARACTERISTICS: Valid through full operating temperature range, T_A = -40°C to 150°C, C_{BYPASS} = 0.1 μF, and V_{CC} = 5 V, unless otherwise specified

Characteristic	Symbol	Test Conditions	Min.	Typ. [1]	Max.	Units
NOMINAL PERFORMANCE						
Current Sensing Range	I _{PR}	Gain Sel 00	-50	-	50	A
		Gain Sel 01	-40	-	40	A
		Gain Sel 10	-33.3	-	33.3	A
		Gain Sel 11	-66.7	-	66.7	A
Sensitivity	Sens	Gain Sel 00; I _{PR(min)} < I _P < I _{PR(max)}	-	40	-	mV/A
		Gain Sel 01; I _{PR(min)} < I _P < I _{PR(max)}	-	50	-	mV/A
		Gain Sel 10; I _{PR(min)} < I _P < I _{PR(max)}	-	60	-	mV/A
		Gain Sel 11; I _{PR(min)} < I _P < I _{PR(max)}	-	30	-	mV/A
Overcurrent Fault Operating Range	I _{OCF-OR}	Typ. = factory-programmed default, FS = Full-Scale	50	100	200	%FS
Zero Current Output Voltage	V _{IOUT(Q)}	Bidirectional; I _P = 0 A, T _A = 25°C	-	2.5	-	V
TOTAL ERROR (V_{IOUT(ACTUAL)} - (Sens_(IDEAL) × I_{PR} + V_{REF})) / (Sens_(IDEAL) × I_{PR}) × 100 AND TOTAL ERROR COMPONENTS						
Total Error	E _{TOT}	I _P = I _{PR(max)}	-1.75	±1.2	1.75	%
Sensitivity Error	E _{SENS}	I _P = I _{PR(max)}	-1.5	±1.1	1.5	%
Zero Current Reference Error	V _{RE}	V _{RE(Factual)} - V _{RE(Fideal)} , I _P = 0 A, T _A = 25°C to 150°C	-10	-1 ±3	10	mV
		V _{RE(Factual)} - V _{RE(Fideal)} , I _P = 0 A, T _A = -40°C to 25°C	-10	-1 ±4	10	mV
Offset Error	V _{OE}	V _{IOUT(Q)} - V _{REF} , I _P = 0 A, T _A = 25°C to 150°C	-8	-1 ±3	8	mV
		V _{IOUT(Q)} - V _{REF} , I _P = 0 A, T _A = -40°C to 25°C	-8	-1 ±4	8	mV
QVO Error	V _{QE}	V _{IOUT(Q)} , I _P = 0 A, T _A = 25°C to 150°C	-10	-2 ±4	10	mV
		V _{IOUT(Q)} , I _P = 0 A, T _A = -40°C to 25°C	-10	-2 ±6	10	mV
TOTAL ERROR AND TOTAL ERROR COMPONENTS INCLUDING LIFETIME DRIFT [2][3]						
Total Error Including Lifetime Drift	E _{TOT_LTD}	I _P = I _{PR(max)}	-4.2	-0.8 ±2.4	4.2	%
Sensitivity Error Including Lifetime Drift	E _{SENS_LTD}	I _P = I _{PR(max)}	-4	-1.3 ±1.7	4	%
Zero Current Reference Error Including Lifetime Drift	V _{RE_LTD}	V _{RE(Factual)} - V _{RE(Fideal)} , I _P = 0 A, T _A = 25°C to 150°C	-10	-1 ±4	10	mV
		V _{RE(Factual)} - V _{RE(Fideal)} , I _P = 0 A, T _A = -40°C to 25°C	-10	-1 ±5	10	mV
Offset Error Including Lifetime Drift	V _{OE_LTD}	V _{IOUT(Q)} - V _{REF} , I _P = 0 A, T _A = 25°C to 150°C	-10	-1 ±6	10	mV
		V _{IOUT(Q)} - V _{REF} , I _P = 0 A, T _A = -40°C to 25°C	-12	-1 ±6	12	mV
QVO Error Including Lifetime Drift	V _{QE_LTD}	V _{IOUT(Q)} , I _P = 0 A, T _A = 25°C to 150°C	-12	-2 ±5	12	mV
		V _{IOUT(Q)} , I _P = 0 A, T _A = -40°C to 25°C	-12	-2 ±6	12	mV

[1] Typical values are the mean ±3 sigma of production distributions. These are formatted as mean ±3 sigma.

[2] Typical values are the mean ±3 sigma statistical combination of production and AEC-Q100 individual drift distributions. These are formatted as mean ±3 sigma.

[3] Lifetime drift characteristics are based on a statistical combination of production distributions and worst-case distribution of parametric drift of individuals observed during AEC-Q100 qualification.

ACS37002LMCATR-050U5

ACS37002LMCATR-050U5 Gain_Sel Pin Performance Key

				Selection Identifier
Parameter (Units)	Gain_Sel_1 (Boolean)	Gain_Sel_0 (Boolean)	Sens (mV/A)	Max I _P (A)
Type	Digital Input	Digital Input	Calculation	Unidirectional
Selection Combination	0	0	80	50
	0	1	100	40
	1	0	120	33.3
	1	1	60	66.7

ACS37002LMCATR-050U5 PERFORMANCE CHARACTERISTICS: Valid through full operating temperature range, T_A = -40°C to 150°C, C_{BYPASS} = 0.1 μF, and V_{CC} = 5 V, unless otherwise specified

Characteristic	Symbol	Test Conditions	Min.	Typ. [1]	Max.	Units
NOMINAL PERFORMANCE						
Current Sensing Range	I _{PR}	Gain Sel 00	0	–	50	A
		Gain Sel 01	0	–	40	A
		Gain Sel 10	0	–	33.3	A
		Gain Sel 11	0	–	66.7	A
Sensitivity	Sens	Gain Sel 00; I _{PR(min)} < I _P < I _{PR(max)}	–	80	–	mV/A
		Gain Sel 01; I _{PR(min)} < I _P < I _{PR(max)}	–	100	–	mV/A
		Gain Sel 10; I _{PR(min)} < I _P < I _{PR(max)}	–	120	–	mV/A
		Gain Sel 11; I _{PR(min)} < I _P < I _{PR(max)}	–	60	–	mV/A
Overcurrent Fault Operating Range	I _{OCF-OR}	Typ. = factory-programmed default, FS = Full-Scale	25	50	100	%FS
Zero Current Output Voltage	V _{IOUT(Q)}	Unidirectional; I _P = 0 A, T _A = 25°C	–	0.5	–	V
TOTAL ERROR (V_{IOUT(ACTUAL)} – (Sens_(IDEAL) × I_{PR} + V_{REF})) / (Sens_(IDEAL) × I_{PR}) × 100 AND TOTAL ERROR COMPONENTS						
Total Error	E _{TOT}	I _P = I _{PR(max)}	–1.75	±1.2	1.75	%
Sensitivity Error	E _{SENS}	I _P = I _{PR(max)} ; T _A = 25°C to 150°C or –40°C to 25°C	–1.5	±1.1	1.5	%
Zero Current Reference Error	V _{RE}	V _{REFactual} – V _{REFideal} ; I _P = 0 A, T _A = 25°C to 150°C	–10	–1 ±3	10	mV
		V _{REFactual} – V _{REFideal} ; I _P = 0 A, T _A = –40°C to 25°C	–10	–1 ±4	10	mV
Offset Error	V _{OE}	V _{IOUT(Q)} – V _{REF} ; I _P = 0 A, T _A = 25°C to 150°C	–8	–1 ±3	8	mV
		V _{IOUT(Q)} – V _{REF} ; I _P = 0 A, T _A = –40°C to 25°C	–8	–1 ±4	8	mV
QVO Error	V _{QE}	V _{IOUT(Q)} ; I _P = 0 A, T _A = 25°C to 150°C	–10	–2 ±4	10	mV
		V _{IOUT(Q)} ; I _P = 0 A, T _A = –40°C to 25°C	–10	–2 ±6	10	mV
TOTAL ERROR AND TOTAL ERROR COMPONENTS INCLUDING LIFETIME DRIFT [2,3]						
Total Error Including Lifetime Drift	E _{TOT_LTD}	I _P = I _{PR(max)}	–4.2	–0.8 ±2.4	4.2	%
Sensitivity Error Including Lifetime Drift	E _{SENS_LTD}	I _P = I _{PR(max)}	–4	–1.3 ±1.7	4	%
Zero Current Reference Error Including Lifetime Drift	V _{RE_LTD}	V _{REFactual} – V _{REFideal} ; I _P = 0 A, T _A = 25°C to 150°C	–10	–1 ±4	10	mV
		V _{REFactual} – V _{REFideal} ; I _P = 0 A, T _A = –40°C to 25°C	–10	–1 ±5	10	mV
Offset Error Including Lifetime Drift	V _{OE_LTD}	V _{IOUT(Q)} – V _{REF} ; I _P = 0 A, T _A = 25°C to 150°C	–10	–1 ±6	10	mV
		V _{IOUT(Q)} – V _{REF} ; I _P = 0 A, T _A = –40°C to 25°C	–12	–1 ±6	12	mV
QVO Error Including Lifetime Drift	V _{QE_LTD}	V _{IOUT(Q)} ; I _P = 0 A, T _A = 25°C to 150°C	–12	–2 ±5	12	mV
		V _{IOUT(Q)} ; I _P = 0 A, T _A = –40°C to 25°C	–12	–2 ±6	12	mV

[1] Typical values are the mean ±3 sigma of production distributions. These are formatted as mean ±3 sigma.

[2] Typical values are the mean ±3 sigma statistical combination of production and AEC-Q100 individual drift distributions. These are formatted as mean ±3 sigma.

[3] Lifetime drift characteristics are based on a statistical combination of production distributions and worst-case distribution of parametric drift of individuals observed during AEC-Q100 qualification.

ACS37002LMCATR-066B5

ACS37002LMCATR-066B5 Gain_Sel Pin Performance Key

				Selection Identifier	
Parameter (Units)	Gain_Sel_1 (Boolean)	Gain_Sel_0 (Boolean)	Sens (mV/A)	Max I _P (A)	
Type	Digital Input	Digital Input	Calculation	Bidirectional	
Selection Combination	0	0	30	66.7	
	0	1	25	80	
	1	0	20	100	
	1	1	15	133.3	

ACS37002LMCATR-066B5 PERFORMANCE CHARACTERISTICS: Valid through full operating temperature range, T_A = -40°C to 150°C, C_{BYPASS} = 0.1 μF, and V_{CC} = 5 V, unless otherwise specified

Characteristic	Symbol	Test Conditions	Min.	Typ. [1]	Max.	Units
NOMINAL PERFORMANCE						
Current Sensing Range	I _{PR}	Gain Sel 00	-66.7	-	66.7	A
		Gain Sel 01	-80	-	80	A
		Gain Sel 10	-100	-	100	A
		Gain Sel 11	-133.3	-	133.3	A
Sensitivity	Sens	Gain Sel 00; I _{PR(min)} < I _P < I _{PR(max)}	-	30	-	mV/A
		Gain Sel 01; I _{PR(min)} < I _P < I _{PR(max)}	-	25	-	mV/A
		Gain Sel 10; I _{PR(min)} < I _P < I _{PR(max)}	-	20	-	mV/A
		Gain Sel 11; I _{PR(min)} < I _P < I _{PR(max)}	-	15	-	mV/A
Overcurrent Fault Operating Range	I _{OCF-OR}	Typ. = factory-programmed default, FS = Full-Scale	50	100	200	%FS
Zero Current Output Voltage	V _{IOUT(Q)}	Bidirectional; I _P = 0 A, T _A = 25°C	-	2.5	-	V
TOTAL ERROR (V_{IOUT(ACTUAL)} - (Sens_(IDEAL) × I_{PR} + V_{REF})) / (Sens_(IDEAL) × I_{PR}) × 100 AND TOTAL ERROR COMPONENTS						
Total Error	E _{TOT}	I _P = I _{PR(max)}	-1.75	±1.2	1.75	%
Sensitivity Error	E _{SENS}	I _P = I _{PR(max)}	-1.5	±1.1	1.5	%
Zero Current Reference Error	V _{RE}	V _{REFactual} - V _{REFideal} , I _P = 0 A, T _A = 25°C to 150°C	-10	-1 ±3	10	mV
		V _{REFactual} - V _{REFideal} , I _P = 0 A, T _A = -40°C to 25°C	-10	-1 ±4	10	mV
Offset Error	V _{OE}	V _{IOUT(Q)} - V _{REF} , I _P = 0 A, T _A = 25°C to 150°C	-8	-1 ±3	8	mV
		V _{IOUT(Q)} - V _{REF} , I _P = 0 A, T _A = -40°C to 25°C	-8	-1 ±4	8	mV
QVO Error	V _{QE}	V _{IOUT(Q)} , I _P = 0 A, T _A = 25°C to 150°C	-10	-2 ±4	10	mV
		V _{IOUT(Q)} , I _P = 0 A, T _A = -40°C to 25°C	-10	-2 ±6	10	mV
TOTAL ERROR AND TOTAL ERROR COMPONENTS INCLUDING LIFETIME DRIFT [2,3]						
Total Error Including Lifetime Drift	E _{TOT_LTD}	I _P = I _{PR(max)}	-4.2	-0.8 ±2.4	4.2	%
Sensitivity Error Including Lifetime Drift	E _{SENS_LTD}	I _P = I _{PR(max)}	-4	-1.3 ±1.7	4	%
Zero Current Reference Error Including Lifetime Drift	V _{RE_LTD}	V _{REFactual} - V _{REFideal} , I _P = 0 A, T _A = 25°C to 150°C	-10	-1 ±4	10	mV
		V _{REFactual} - V _{REFideal} , I _P = 0 A, T _A = -40°C to 25°C	-10	-1 ±5	10	mV
Offset Error Including Lifetime Drift	V _{OE_LTD}	V _{IOUT(Q)} - V _{REF} , I _P = 0 A, T _A = 25°C to 150°C	-10	-1 ±6	10	mV
		V _{IOUT(Q)} - V _{REF} , I _P = 0 A, T _A = -40°C to 25°C	-12	-1 ±6	12	mV
QVO Error Including Lifetime Drift	V _{QE_LTD}	V _{IOUT(Q)} , I _P = 0 A, T _A = 25°C to 150°C	-12	-2 ±5	12	mV
		V _{IOUT(Q)} , I _P = 0 A, T _A = -40°C to 25°C	-12	-2 ±6	12	mV

[1] Typical values are the mean ±3 sigma of production distributions. These are formatted as mean ±3 sigma.

[2] Typical values are the mean ±3 sigma statistical combination of production and AEC-Q100 individual drift distributions. These are formatted as mean ±3 sigma.

[3] Lifetime drift characteristics are based on a statistical combination of production distributions and worst-case distribution of parametric drift of individuals observed during AEC-Q100 qualification.

ACS37002LMCATR-090B5

ACS37002LMCATR-090B5 Gain_Sel Pin Performance Key

				Selection Identifier
Parameter (Units)	Gain_Sel_1 (Boolean)	Gain_Sel_0 (Boolean)	Sens (mV/A)	Max I _P (A)
Type	Digital Input	Digital Input	Calculation	Bidirectional
Selection Combination	0	0	22.2	90
	0	1	18.5	108
	1	0	14.8	135
	1	1	11.1	180

ACS37002LMCATR-090B5 PERFORMANCE CHARACTERISTICS: Valid through full operating temperature range, T_A = -40°C to 150°C, C_{BYPASS} = 0.1 μF, and V_{CC} = 5 V, unless otherwise specified

Characteristic	Symbol	Test Conditions	Min.	Typ. [1]	Max.	Units
NOMINAL PERFORMANCE						
Current Sensing Range	I _{PR}	Gain Sel 00	-90	-	90	A
		Gain Sel 01	-108	-	108	A
		Gain Sel 10	-135	-	135	A
		Gain Sel 11	-180	-	180	A
Sensitivity	Sens	Gain Sel 00; I _{PR(min)} < I _P < I _{PR(max)}	-	22.2	-	mV/A
		Gain Sel 01; I _{PR(min)} < I _P < I _{PR(max)}	-	18.5	-	mV/A
		Gain Sel 10; I _{PR(min)} < I _P < I _{PR(max)}	-	14.8	-	mV/A
		Gain Sel 11; I _{PR(min)} < I _P < I _{PR(max)}	-	11.1	-	mV/A
Overcurrent Fault Operating Range	I _{OCF-OR}	Typ. = factory-programmed default, FS = Full-Scale	50	100	200	%FS
Zero Current Output Voltage	V _{IOUT(Q)}	Bidirectional; I _P = 0 A, T _A = 25°C	-	2.5	-	V
TOTAL ERROR (V_{IOUT(ACTUAL)} - (Sens_(IDEAL) × I_{PR} + V_{REF})) / (Sens_(IDEAL) × I_{PR}) × 100 AND TOTAL ERROR COMPONENTS						
Total Error	E _{TOT}	I _P = I _{PR(max)}	-1.75	±1.2	1.75	%
Sensitivity Error	E _{SENS}	I _P = I _{PR(max)}	-1.5	±1.1	1.5	%
Zero Current Reference Error	V _{RE}	V _{REFactual} - V _{REFideal} , I _P = 0 A, T _A = 25°C to 150°C	-10	-1 ±3	10	mV
		V _{REFactual} - V _{REFideal} , I _P = 0 A, T _A = -40°C to 25°C	-10	-1 ±4	10	mV
Offset Error	V _{OE}	V _{IOUT(Q)} - V _{REF} , I _P = 0 A, T _A = 25°C to 150°C	-8	-1 ±3	8	mV
		V _{IOUT(Q)} - V _{REF} , I _P = 0 A, T _A = -40°C to 25°C	-8	-1 ±4	8	mV
QVO Error	V _{QE}	V _{IOUT(Q)} , I _P = 0 A, T _A = 25°C to 150°C	-10	-2 ±4	10	mV
		V _{IOUT(Q)} , I _P = 0 A, T _A = -40°C to 25°C	-10	-2 ±6	10	mV
TOTAL ERROR AND TOTAL ERROR COMPONENTS INCLUDING LIFETIME DRIFT [2,3]						
Total Error Including Lifetime Drift	E _{TOT_LTD}	I _P = I _{PR(max)}	-4.2	-0.8 ±2.4	4.2	%
Sensitivity Error Including Lifetime Drift	E _{SENS_LTD}	I _P = I _{PR(max)}	-4	-1.3 ±1.7	4	%
Zero Current Reference Error Including Lifetime Drift	V _{RE_LTD}	V _{REFactual} - V _{REFideal} , I _P = 0 A, T _A = 25°C to 150°C	-10	-1 ±4	10	mV
		V _{REFactual} - V _{REFideal} , I _P = 0 A, T _A = -40°C to 25°C	-10	-1 ±5	10	mV
Offset Error Including Lifetime Drift	V _{OE_LTD}	V _{IOUT(Q)} - V _{REF} , I _P = 0 A, T _A = 25°C to 150°C	-10	-1 ±6	10	mV
		V _{IOUT(Q)} - V _{REF} , I _P = 0 A, T _A = -40°C to 25°C	-12	-1 ±6	12	mV
QVO Error Including Lifetime Drift	V _{QE_LTD}	V _{IOUT(Q)} , I _P = 0 A, T _A = 25°C to 150°C	-12	-2 ±5	12	mV
		V _{IOUT(Q)} , I _P = 0 A, T _A = -40°C to 25°C	-12	-2 ±6	12	mV

[1] Typical values are the mean ±3 sigma of production distributions. These are formatted as mean ±3 sigma.

[2] Typical values are the mean ±3 sigma statistical combination of production and AEC-Q100 individual drift distributions. These are formatted as mean ±3 sigma.

[3] Lifetime drift characteristics are based on a statistical combination of production distributions and worst-case distribution of parametric drift of individuals observed during AEC-Q100 qualification.

ACS37002LMCATR-050B3

ACS37002LMCATR-050B3 Gain_Sel Pin Performance Key

				Selection Identifier
Parameter (Units)	Gain_Sel_1 (Boolean)	Gain_Sel_0 (Boolean)	Sens (mV/A)	Max I _P (A)
Type	Digital Input	Digital Input	Calculation	Bidirectional
Selection Combination	0	0	26.4	50
	0	1	33	40
	1	0	39.6	33.3
	1	1	19.8	66.7

ACS37002LMCATR-050B3 PERFORMANCE CHARACTERISTICS: Valid through full operating temperature range, T_A = -40°C to 150°C, C_{BYPASS} = 0.1 μF, and V_{CC} = 3.3 V, unless otherwise specified

Characteristic	Symbol	Test Conditions	Min.	Typ. [1]	Max.	Units
NOMINAL PERFORMANCE						
Current Sensing Range	I _{PR}	Gain Sel 00	-50	-	50	A
		Gain Sel 01	-40	-	40	A
		Gain Sel 10	-33.3	-	33.3	A
		Gain Sel 11	-66.7	-	66.7	A
Sensitivity	Sens	Gain Sel 00; I _{PR(min)} < I _P < I _{PR(max)}	-	26.4	-	mV/A
		Gain Sel 01; I _{PR(min)} < I _P < I _{PR(max)}	-	33	-	mV/A
		Gain Sel 10; I _{PR(min)} < I _P < I _{PR(max)}	-	39.6	-	mV/A
		Gain Sel 11; I _{PR(min)} < I _P < I _{PR(max)}	-	19.8	-	mV/A
Overcurrent Fault Operating Range	I _{OCF-OR}	Typ. = factory-programmed default, FS = Full-Scale	50	100	200	%FS
Zero Current Output Voltage	V _{IOUT(Q)}	Bidirectional; I _P = 0 A, T _A = 25°C	-	1.65	-	V
TOTAL ERROR (V_{IOUT(ACTUAL)} - (Sens_(IDEAL) × I_{PR} + V_{REF})) / (Sens_(IDEAL) × I_{PR}) × 100 AND TOTAL ERROR COMPONENTS						
Total Error	E _{TOT}	I _P = I _{PR(max)}	-1.75	±1.2	1.75	%
Sensitivity Error	E _{SENS}	I _P = I _{PR(max)}	-1.5	±1.1	1.5	%
Zero Current Reference Error	V _{RE}	V _{REFactual} - V _{REFideal} , I _P = 0 A, T _A = 25°C to 150°C	-10	-1 ±3	10	mV
		V _{REFactual} - V _{REFideal} , I _P = 0 A, T _A = -40°C to 25°C	-10	-1 ±4	10	mV
Offset Error	V _{OE}	V _{IOUT(Q)} - V _{REF} , I _P = 0 A, T _A = 25°C to 150°C	-10	-1 ±3	10	mV
		V _{IOUT(Q)} - V _{REF} , I _P = 0 A, T _A = -40°C to 25°C	-10	-1 ±4	10	mV
QVO Error	V _{QE}	V _{IOUT(Q)} , I _P = 0 A, T _A = 25°C to 150°C	-10	-2 ±4	10	mV
		V _{IOUT(Q)} , I _P = 0 A, T _A = -40°C to 25°C	-10	-2 ±6	10	mV
TOTAL ERROR AND TOTAL ERROR COMPONENTS INCLUDING LIFETIME DRIFT [2,3]						
Total Error Including Lifetime Drift	E _{TOT_LTD}	I _P = I _{PR(max)}	-4.2	-0.8 ±2.4	4.2	%
Sensitivity Error Including Lifetime Drift	E _{SENS_LTD}	I _P = I _{PR(max)}	-4	-1.3 ±1.7	4	%
Zero Current Reference Error Including Lifetime Drift	V _{RE_LTD}	V _{REFactual} - V _{REFideal} , I _P = 0 A, T _A = 25°C to 150°C	-10	-1 ±4	10	mV
		V _{REFactual} - V _{REFideal} , I _P = 0 A, T _A = -40°C to 25°C	-10	-1 ±5	10	mV
Offset Error Including Lifetime Drift	V _{OE_LTD}	V _{IOUT(Q)} - V _{REF} , I _P = 0 A, T _A = 25°C to 150°C	-10	-1 ±6	10	mV
		V _{IOUT(Q)} - V _{REF} , I _P = 0 A, T _A = -40°C to 25°C	-12	-1 ±6	12	mV
QVO Error Including Lifetime Drift	V _{QE_LTD}	V _{IOUT(Q)} , I _P = 0 A, T _A = 25°C to 150°C	-12	-2 ±5	12	mV
		V _{IOUT(Q)} , I _P = 0 A, T _A = -40°C to 25°C	-12	-2 ±6	12	mV

[1] Typical values are the mean ±3 sigma of production distributions. These are formatted as mean ±3 sigma.

[2] Typical values are the mean ±3 sigma statistical combination of production and AEC-Q100 individual drift distributions. These are formatted as mean ±3 sigma.

[3] Lifetime drift characteristics are based on a statistical combination of production distributions and worst-case distribution of parametric drift of individuals observed during AEC-Q100 qualification.

ACS37002LMCATR-066B3

ACS37002LMCATR-066B3 Gain_Sel Pin Performance Key

				Selection Identifier
Parameter (Units)	Gain_Sel_1 (Boolean)	Gain_Sel_0 (Boolean)	Sens (mV/A)	Max I _P (A)
Type	Digital Input	Digital Input	Calculation	Bidirectional
Selection Combination	0	0	19.8	66.7
	0	1	16.5	80
	1	0	13.2	100
	1	1	9.9	133.3

ACS37002LMCATR-066B3 PERFORMANCE CHARACTERISTICS: Valid through full operating temperature range, T_A = -40°C to 150°C, C_{BYPASS} = 0.1 μF, and V_{CC} = 3.3 V, unless otherwise specified

Characteristic	Symbol	Test Conditions	Min.	Typ. [1]	Max.	Units
NOMINAL PERFORMANCE						
Current Sensing Range	I _{PR}	Gain Sel 00	-66.7	-	66.7	A
		Gain Sel 01	-80	-	80	A
		Gain Sel 10	-100	-	100	A
		Gain Sel 11	-133.3	-	133.3	A
Sensitivity	Sens	Gain Sel 00; I _{PR(min)} < I _P < I _{PR(max)}	-	19.8	-	mV/A
		Gain Sel 01; I _{PR(min)} < I _P < I _{PR(max)}	-	16.5	-	mV/A
		Gain Sel 10; I _{PR(min)} < I _P < I _{PR(max)}	-	13.2	-	mV/A
		Gain Sel 11; I _{PR(min)} < I _P < I _{PR(max)}	-	9.9	-	mV/A
Overcurrent Fault Operating Range	I _{OCF-OR}	Typ. = factory-programmed default, FS = Full-Scale	50	100	200	%FS
Zero Current Output Voltage	V _{IOUT(Q)}	Bidirectional; I _P = 0 A, T _A = 25°C	-	1.65	-	V
TOTAL ERROR (V_{IOUT(ACTUAL)} - (Sens_(IDEAL) × I_{PR} + V_{REF})) / (Sens_(IDEAL) × I_{PR}) × 100 AND TOTAL ERROR COMPONENTS						
Total Error	E _{TOT}	I _P = I _{PR(max)}	-1.75	±1.2	1.75	%
Sensitivity Error	E _{SENS}	I _P = I _{PR(max)}	-1.5	±1.1	1.5	%
Zero Current Reference Error	V _{RE}	V _{REFactual} - V _{REFideal} , I _P = 0 A, T _A = 25°C to 150°C	-10	-1 ±3	10	mV
		V _{REFactual} - V _{REFideal} , I _P = 0 A, T _A = -40°C to 25°C	-10	-1 ±4	10	mV
Offset Error	V _{OE}	V _{IOUT(Q)} - V _{REF} , I _P = 0 A, T _A = 25°C to 150°C	-10	-1 ±3	10	mV
		V _{IOUT(Q)} - V _{REF} , I _P = 0 A, T _A = -40°C to 25°C	-10	-1 ±4	10	mV
QVO Error	V _{QE}	V _{IOUT(Q)} , I _P = 0 A, T _A = 25°C to 150°C	-10	-2 ±4	10	mV
		V _{IOUT(Q)} , I _P = 0 A, T _A = -40°C to 25°C	-10	-2 ±6	10	mV
TOTAL ERROR AND TOTAL ERROR COMPONENTS INCLUDING LIFETIME DRIFT [2,3]						
Total Error Including Lifetime Drift	E _{TOT_LTD}	I _P = I _{PR(max)}	-4.2	-0.8 ±2.4	4.2	%
Sensitivity Error Including Lifetime Drift	E _{SENS_LTD}	I _P = I _{PR(max)}	-4	-1.3 ±1.7	4	%
Zero Current Reference Error Including Lifetime Drift	V _{RE_LTD}	V _{REFactual} - V _{REFideal} , I _P = 0 A, T _A = 25°C to 150°C	-10	-1 ±4	10	mV
		V _{REFactual} - V _{REFideal} , I _P = 0 A, T _A = -40°C to 25°C	-10	-1 ±5	10	mV
Offset Error Including Lifetime Drift	V _{OE_LTD}	V _{IOUT(Q)} - V _{REF} , I _P = 0 A, T _A = 25°C to 150°C	-10	-1 ±6	10	mV
		V _{IOUT(Q)} - V _{REF} , I _P = 0 A, T _A = -40°C to 25°C	-12	-1 ±6	12	mV
QVO Error Including Lifetime Drift	V _{QE_LTD}	V _{IOUT(Q)} , I _P = 0 A, T _A = 25°C to 150°C	-12	-2 ±5	12	mV
		V _{IOUT(Q)} , I _P = 0 A, T _A = -40°C to 25°C	-12	-2 ±6	12	mV

[1] Typical values are the mean ±3 sigma of production distributions. These are formatted as mean ±3 sigma.

[2] Typical values are the mean ±3 sigma statistical combination of production and AEC-Q100 individual drift distributions. These are formatted as mean ±3 sigma.

[3] Lifetime drift characteristics are based on a statistical combination of production distributions and worst-case distribution of parametric drift of individuals observed during AEC-Q100 qualification.

ACS37002LMCATR-066U3

ACS37002LMCATR-066U3 Gain_Sel Pin Performance Key

				Selection Identifier
Parameter (Units)	Gain_Sel_1 (Boolean)	Gain_Sel_0 (Boolean)	Sens (mV/A)	Max I _P (A)
Type	Digital Input	Digital Input	Calculation	Unidirectional
Selection Combination	0	0	39.6	66.7
	0	1	33	80
	1	0	26.4	100
	1	1	19.8	133.3

ACS37002LMCATR-066U3 PERFORMANCE CHARACTERISTICS: Valid through full operating temperature range, T_A = -40°C to 150°C, C_{BYPASS} = 0.1 μF, and V_{CC} = 3.3 V, unless otherwise specified

Characteristic	Symbol	Test Conditions	Min.	Typ. [1]	Max.	Units
NOMINAL PERFORMANCE						
Current Sensing Range	I _{PR}	Gain Sel 00	0	–	66.7	A
		Gain Sel 01	0	–	80	A
		Gain Sel 10	0	–	100	A
		Gain Sel 11	0	–	133.3	A
Sensitivity	Sens	Gain Sel 00; I _{PR(min)} < I _P < I _{PR(max)}	–	39.6	–	mV/A
		Gain Sel 01; I _{PR(min)} < I _P < I _{PR(max)}	–	33	–	mV/A
		Gain Sel 10; I _{PR(min)} < I _P < I _{PR(max)}	–	26.4	–	mV/A
		Gain Sel 11; I _{PR(min)} < I _P < I _{PR(max)}	–	19.8	–	mV/A
Overcurrent Fault Operating Range	I _{OCF-OR}	Typ. = factory-programmed default, FS = Full-Scale	25	50	100	%FS
Zero Current Output Voltage	V _{IOUT(Q)}	Unidirectional; I _P = 0 A, T _A = 25°C	–	0.5	–	V
TOTAL ERROR (V_{IOUT(ACTUAL)} – (Sens_(IDEAL) × I_{PR} + V_{REF})) / (Sens_(IDEAL) × I_{PR}) × 100 AND TOTAL ERROR COMPONENTS						
Total Error	E _{TOT}	I _P = I _{PR(max)}	–1.75	±1.2	1.75	%
Sensitivity Error	E _{SENS}	I _P = I _{PR(max)} ; T _A = 25°C to 150°C or –40°C to 25°C	–1.5	±1.1	1.5	%
Zero Current Reference Error	V _{RE}	V _{REFactual} – V _{REFideal} ; I _P = 0 A, T _A = 25°C to 150°C	–10	–1 ±3	10	mV
		V _{REFactual} – V _{REFideal} ; I _P = 0 A, T _A = –40°C to 25°C	–10	–1 ±4	10	mV
Offset Error	V _{OE}	V _{IOUT(Q)} – V _{REF} ; I _P = 0 A, T _A = 25°C to 150°C	–8	–1 ±3	8	mV
		V _{IOUT(Q)} – V _{REF} ; I _P = 0 A, T _A = –40°C to 25°C	–8	–1 ±4	8	mV
QVO Error	V _{QE}	V _{IOUT(Q)} ; I _P = 0 A, T _A = 25°C to 150°C	–10	–2 ±4	10	mV
		V _{IOUT(Q)} ; I _P = 0 A, T _A = –40°C to 25°C	–10	–2 ±6	10	mV
TOTAL ERROR AND TOTAL ERROR COMPONENTS INCLUDING LIFETIME DRIFT [2,3]						
Total Error Including Lifetime Drift	E _{TOT_LTD}	I _P = I _{PR(max)}	–4.2	–0.8 ±2.4	4.2	%
Sensitivity Error Including Lifetime Drift	E _{SENS_LTD}	I _P = I _{PR(max)}	–4	–1.3 ±1.7	4	%
Zero Current Reference Error Including Lifetime Drift	V _{RE_LTD}	V _{REFactual} – V _{REFideal} ; I _P = 0 A, T _A = 25°C to 150°C	–10	–1 ±4	10	mV
		V _{REFactual} – V _{REFideal} ; I _P = 0 A, T _A = –40°C to 25°C	–10	–1 ±5	10	mV
Offset Error Including Lifetime Drift	V _{OE_LTD}	V _{IOUT(Q)} – V _{REF} ; I _P = 0 A, T _A = 25°C to 150°C	–10	–1 ±6	10	mV
		V _{IOUT(Q)} – V _{REF} ; I _P = 0 A, T _A = –40°C to 25°C	–12	–1 ±6	12	mV
QVO Error Including Lifetime Drift	V _{QE_LTD}	V _{IOUT(Q)} ; I _P = 0 A, T _A = 25°C to 150°C	–12	–2 ±5	12	mV
		V _{IOUT(Q)} ; I _P = 0 A, T _A = –40°C to 25°C	–12	–2 ±6	12	mV

[1] Typical values are the mean ±3 sigma of production distributions. These are formatted as mean ±3 sigma.

[2] Typical values are the mean ±3 sigma statistical combination of production and AEC-Q100 individual drift distributions. These are formatted as mean ±3 sigma.

[3] Lifetime drift characteristics are based on a statistical combination of production distributions and worst-case distribution of parametric drift of individuals observed during AEC-Q100 qualification.

ACS37002LMCATR-090B3

ACS37002LMCATR-090B3 Gain_Sel Pin Performance Key

				Selection Identifier
Parameter (Units)	Gain_Sel_1 (Boolean)	Gain_Sel_0 (Boolean)	Sens (mV/A)	Max I _P (A)
Type	Digital Input	Digital Input	Calculation	Bidirectional
Selection Combination	0	0	14.7	90
	0	1	12.2	108
	1	0	9.8	135
	1	1	7.3	180

ACS37002LMCATR-090B3 PERFORMANCE CHARACTERISTICS: Valid through full operating temperature range, T_A = -40°C to 150°C, C_{BYPASS} = 0.1 μF, and V_{CC} = 3.3 V, unless otherwise specified

Characteristic	Symbol	Test Conditions	Min.	Typ. [1]	Max.	Units
NOMINAL PERFORMANCE						
Current Sensing Range	I _{PR}	Gain Sel 00	-90	-	90	A
		Gain Sel 01	-108	-	108	A
		Gain Sel 10	-135	-	135	A
		Gain Sel 11	-180	-	180	A
Sensitivity	Sens	Gain Sel 00; I _{PR(min)} < I _P < I _{PR(max)}	-	14.7	-	mV/A
		Gain Sel 01; I _{PR(min)} < I _P < I _{PR(max)}	-	12.2	-	mV/A
		Gain Sel 10; I _{PR(min)} < I _P < I _{PR(max)}	-	9.8	-	mV/A
		Gain Sel 11; I _{PR(min)} < I _P < I _{PR(max)}	-	7.3	-	mV/A
Overcurrent Fault Operating Range	I _{OCF-OR}	Typ. = factory-programmed default, FS = Full-Scale	50	100	200	%FS
Zero Current Output Voltage	V _{IOUT(Q)}	Bidirectional; I _P = 0 A, T _A = 25°C	-	1.65	-	V
TOTAL ERROR (V_{IOUT(ACTUAL)} - (Sens_(IDEAL) × I_{PR} + V_{REF})) / (Sens_(IDEAL) × I_{PR}) × 100 AND TOTAL ERROR COMPONENTS						
Total Error	E _{TOT}	I _P = I _{PR(max)}	-1.75	±1.2	1.75	%
Sensitivity Error	E _{SENS}	I _P = I _{PR(max)}	-1.5	±1.1	1.5	%
Zero Current Reference Error	V _{RE}	V _{REFactual} - V _{REFideal} , I _P = 0 A, T _A = 25°C to 150°C	-10	-1 ±3	10	mV
		V _{REFactual} - V _{REFideal} , I _P = 0 A, T _A = -40°C to 25°C	-10	-1 ±4	10	mV
Offset Error	V _{OE}	V _{IOUT(Q)} - V _{REF} , I _P = 0 A, T _A = 25°C to 150°C	-10	-1 ±3	10	mV
		V _{IOUT(Q)} - V _{REF} , I _P = 0 A, T _A = -40°C to 25°C	-10	-1 ±4	10	mV
QVO Error	V _{QE}	V _{IOUT(Q)} , I _P = 0 A, T _A = 25°C to 150°C	-10	-2 ±4	10	mV
		V _{IOUT(Q)} , I _P = 0 A, T _A = -40°C to 25°C	-10	-2 ±6	10	mV
TOTAL ERROR AND TOTAL ERROR COMPONENTS INCLUDING LIFETIME DRIFT [2,3]						
Total Error Including Lifetime Drift	E _{TOT_LTD}	I _P = I _{PR(max)}	-4.2	-0.8 ±2.4	4.2	%
Sensitivity Error Including Lifetime Drift	E _{SENS_LTD}	I _P = I _{PR(max)}	-4	-1.3 ±1.7	4	%
Zero Current Reference Error Including Lifetime Drift	V _{RE_LTD}	V _{REFactual} - V _{REFideal} , I _P = 0 A, T _A = 25°C to 150°C	-10	-1 ±4	10	mV
		V _{REFactual} - V _{REFideal} , I _P = 0 A, T _A = -40°C to 25°C	-10	-1 ±5	10	mV
Offset Error Including Lifetime Drift	V _{OE_LTD}	V _{IOUT(Q)} - V _{REF} , I _P = 0 A, T _A = 25°C to 150°C	-10	-1 ±6	10	mV
		V _{IOUT(Q)} - V _{REF} , I _P = 0 A, T _A = -40°C to 25°C	-12	-1 ±6	12	mV
QVO Error Including Lifetime Drift	V _{QE_LTD}	V _{IOUT(Q)} , I _P = 0 A, T _A = 25°C to 150°C	-12	-2 ±5	12	mV
		V _{IOUT(Q)} , I _P = 0 A, T _A = -40°C to 25°C	-12	-2 ±6	12	mV

[1] Typical values are the mean ±3 sigma of production distributions. These are formatted as mean ±3 sigma.

[2] Typical values are the mean ±3 sigma statistical combination of production and AEC-Q100 individual drift distributions. These are formatted as mean ±3 sigma.

[3] Lifetime drift characteristics are based on a statistical combination of production distributions and worst-case distribution of parametric drift of individuals observed during AEC-Q100 qualification.

CHARACTERISTIC PERFORMANCE ACS37002LMC TYPICAL FREQUENCY RESPONSE

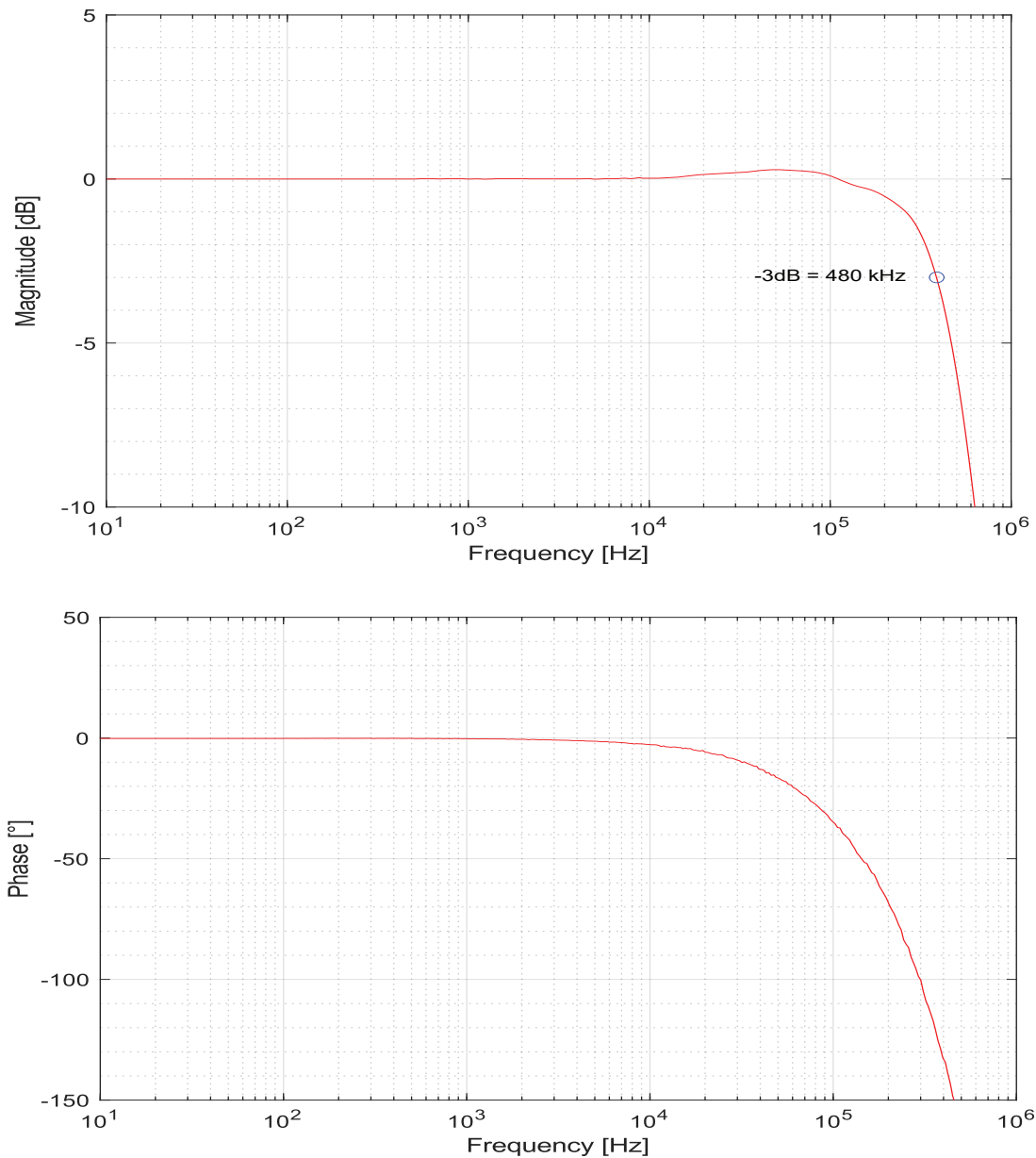

For information regarding bandwidth characterization methods used for the ACS37002, see the “Characterizing System Bandwidth” application note (<https://allegromicro.com/en/insights-and-innovations/technical-documents/hall-effect-sensor-ic-publications/an-effective-method-for-characterizing-system-bandwidth-an296169>) on the Allegro website.

FUNCTIONAL DESCRIPTION

Power-On Reset Operation

The descriptions in this section use the listed test conditions and assume a temperature of 25°C. The provided graphs in this section show V_{IOUT} moving with V_{CC} . The voltage of V_{IOUT} during a high-impedance state will be most consistent with a known load (R_L , C_L).

POWER-ON

As V_{CC} ramps up, V_{IOUT} and V_{REF} pins are high impedance until V_{CC} reaches and passes $V_{POR(H)}$.

POWER-OFF

As V_{CC} drops below $V_{POR(L)}$, the outputs will enter a high-impedance state.

Note: Since the device is entering a high-impedance state, and not driving the output, the time it takes the output to reach a steady state will depend on the external circuitry used.

POWER-ON RESET (POR)

If V_{CC} falls below $V_{POR(L)}$ while in operation, the device will enter a POR event and reset, V_{IOUT} and V_{REF} will switch to high-impedance state.

POWER-ON DELAY (T_{POD})

When the supply is ramped to $V_{POR(H)}$, the device will require a finite time to power its internal components before the outputs are released from high impedance and can respond to an input magnetic field [A]. Power-On Time, t_{POD} , is defined as the time it takes for the output voltage to settle within $\pm 10\%$ of its steady-state value under an applied magnetic field. After this delay, the output will quickly approach $V_{IOUT(IP)} = \text{Sens} \times I_P + V_{REF}$.

Overvoltage Detection (OVD)

To ensure that the device's output is reporting accurately, the device contains an overvoltage detection flag. This flag on V_{IOUT} can be used to alert the system when the supply voltage for the device is outside of the operational range.

OVERVOLTAGE DETECTION VOLTAGE THRESHOLDS ($V_{OVD(H/L)}$)

When V_{CC} raises above $V_{OVD(H)}$, the V_{IOUT} pin output will go high impedance and V_{IOUT} will be pulled to either V_{CC} or GND , depending if R_L is in a pull-up or pull-down configuration.

OVERVOLTAGE DETECTION HYSTERESIS ($V_{OVD(HYS)}$)

There is hysteresis between enable and disable thresholds to reduce nuisance flagging and clears.

OVERVOLTAGE ENABLE AND DISABLE TIME ($T_{OVD(E/D)}$)

The enable time for OVD, $t_{OVD(E)}$, is the time from $V_{OVD(H)}$ to OVD flag [B]. The OVD enable flag has a counter to reduce transients faster than 64 μs from triggering nuisance flags.

The disable time for OVD, $t_{OVD(D)}$, is the time from $V_{OVD(L)}$ to the OVD clear to normal operation [C]. The disable time for OVD does not have a counter to release the output and resume reporting.

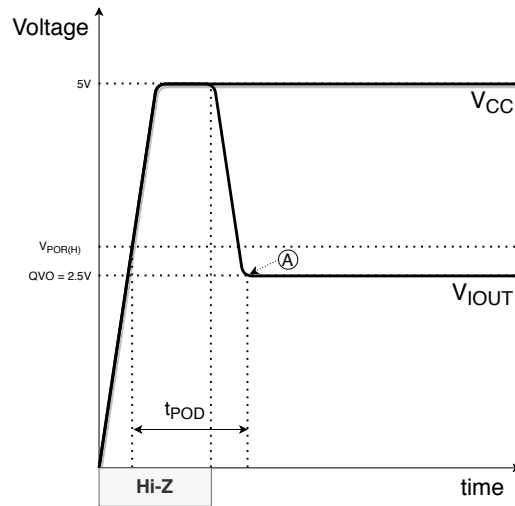

Figure 4: t_{POD} behavior with $R_L = \text{Pull-Up}$

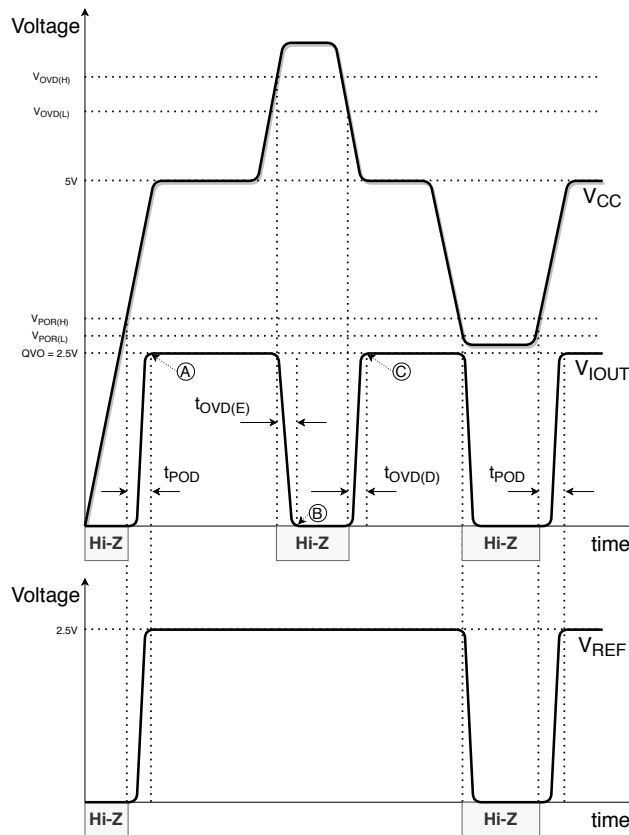

Figure 5: t_{POD} and $t_{OVD(E/D)}$ with $R_L = \text{Pull-Down}$

Absolute Maximum Ratings

These are the maximum application or environmental conditions that the device can be subjected before damage may occur.

FORWARD AND REVERSE SUPPLY VOLTAGE

These are the largest voltage magnitudes that can be supplied to V_{CC} from GND during programming or transient switching. This voltage should not be used as a DC voltage bias for an extended time.

FORWARD AND REVERSE OUTPUT VOLTAGE

The Forward Output Voltage, V_{IOUT} , should be no greater than $V_{CC} + 0.5$ up to 6.5 V. This is the greatest voltage that the output can be biased with from GND during programming or transient switching. The Reverse Output Voltage, V_{RIOUT} , should not drop below -0.5 V during programming or transient switching. These voltages should not be used as a DC voltage bias for an extended time.

FORWARD AND REVERSE INPUT VOLTAGE

The Forward Input Voltage, V_{OI} , should be no greater than $V_{CC} + 0.5$ V, up to 6.5 V. This is the greatest voltage that the input can be applied during programming or transient switching. The Reverse Input Voltage, V_{ROI} , should not drop below -0.5 V during programming or transient switching.

OUTPUT SOURCE AND SINK CURRENT

This is the maximum current that V_{IOUT} can passively sink or source before damage may occur.

AMBIENT TEMPERATURE (T_A)

This is the ambient temperature of the device. The Operating Ambient Temperature Range is the ambient temperature range in which the Common Electricals and Common Performance Characteristics limits are valid.

DEFINITIONS OF OPERATING AND PERFORMANCE CHARACTERISTICS

Zero Current Voltage Output ($V_{IOUT(Q)}$, QVO)

Zero Current Voltage Output or $V_{IOUT(Q)}$ (also called QVO) is defined as the voltage on the output, V_{IOUT} , when 0 A are applied through I_p .

QVO Temperature Drift (V_{QE})

QVO Temperature Drift, or V_{QE} , is defined as the drift of QVO from room to hot or room to cold (25°C to 150°C or 25°C to -40°C respectively). To improve over temperature performance the temperature drift is compensated with Allegro's factory trim to remain within the limits across temperature.

Reference Voltage (V_{REF})

There is a Voltage Reference Output, (V_{REF}) on the ACS37002LMC. This output reports the zero-current voltage for the output channel V_{IOUT} allowing for differential measurement and a device referred supply for the VOC pin.

Reference Voltage Temperature Drift (V_{RE})

Reference Voltage Temperature Drift, or V_{RE} , is defined as the drift of V_{REF} from room to hot or room to cold (25°C to 150°C or 25°C to -40°C respectively).

Offset Voltage (V_{OE})

Offset Voltage, or V_{OE} , is defined as the difference between QVO and V_{REF} (see Figure 6). V_{OE} includes the drift of QVO minus V_{REF} from room to hot or room to cold (25°C to 150°C or 25°C to -40°C respectively).

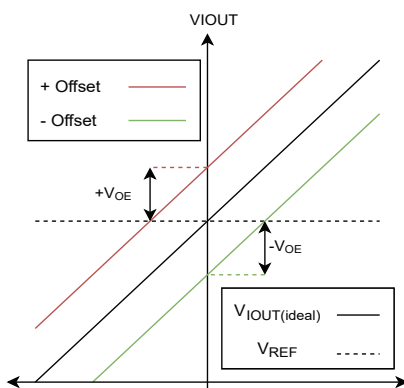

Figure 6: Offset (V_{OE}) Between V_{IOUT} and V_{REF}

Output Saturation Voltage ($V_{SAT(HIGH/LOW)}$)

Output Saturation Voltage, or V_{SAT} , is defined as the voltage that V_{IOUT} does not pass as a result to an increasing magnitude of current. $V_{SAT(HIGH)}$ is the highest voltage the output can drive to while, $V_{SAT(LOW)}$ is the lowest. This can be seen in Figure 7. Note that changing the sensitivity does not change the V_{SAT} points.

OUTPUT VOLTAGE OPERATING RANGE (V_{OOR})

The Output Voltage Operating Range, or V_{OOR} , is the functional range for linear performance of V_{IOUT} and its related datasheet parameters. This can be seen in Figure 7. The V_{OOR} is the output region that the performance accuracy parameters are valid. It is possible for the output to report beyond these voltages until V_{SAT} . The output performance is demonstrated in Figure 7 through and beyond the V_{OOR} .

Voltage Output Operating Range for V_{CC} and Output Modes, $V_{OOR}(V_{CC}, Mode)$		
V_{CC} (V)	Bidirectional	Unidirectional
3.3	± 1.32	+2.64
5	± 2	+4

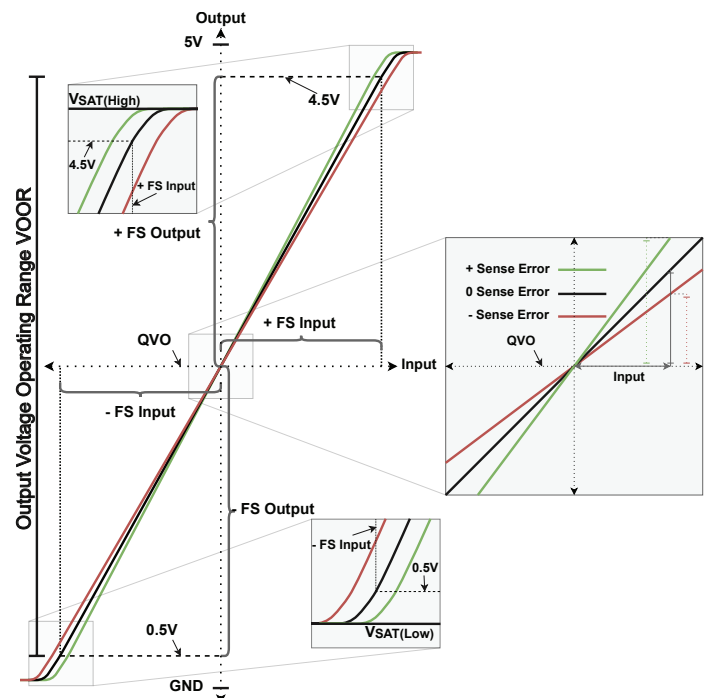

Figure 7: V_{OOR} , V_{SAT} and SENS with Full Scale

Sensitivity (Sens)

Sensitivity, or Sens, is the ratio of the output swing versus the applied current through the primary conductor, I_P . This current causes a voltage deviation away from QVO on the V_{IOUT} output until V_{SAT} . The magnitude and direction of the output voltage swing is proportional to the magnitude and direction of the applied current. This proportional relationship between output and input is Sensitivity and is defined as:

$$Sens = \frac{V_{IOUT(IP1)} - V_{IOUT(IP2)}}{I_{P1} - I_{P2}}$$

where I_{P1} and I_{P2} are two different currents, and $V_{IOUT(IP1)}$ and $V_{IOUT(IP2)}$ are the voltages of the device at the applied currents. $V_{IOUT(IP1)}$ or $V_{IOUT(IP2)}$ can be QVO with zero current.

Sensitivity Error (E_{sens})

Sensitivity Temperature Drift, or E_{sens} , is the drift of Sens from room to hot or room to cold (25°C to 150°C or 25°C to -40°C, respectively). No trimming/programming is needed as temperature drift is compensated with Allegro's factory trim to remain within the datasheet limits across temperature.

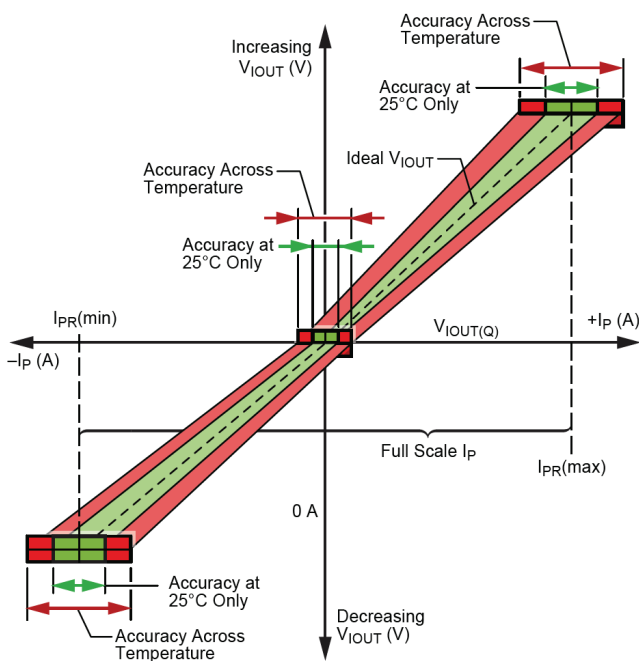

Figure 8: Output Accuracy Pocket for Room and Across Temperature

Gain Selection Pins

The ACS37002LMC features external gain selection pins that configure the device sensitivity. The gain select logic is latched based on the pin voltage at startup. Either pin may be shorted directly to VCC or GND, which is logic 1 or 0 respectively. Both pins include an internal 1 MΩ pull-down resistor to GND. Externally floating pins will be interpreted as logic 0; if both pins are floating, the device will be in the 00 configuration. Specific gain select performance can be found in the selection Performance Characteristics table. To change the gain of the device, refer to Figure 18 in the Application and Theory section.

Full Scale (FS)

Full Scale, or FS, is a method to relate an input and/or output to the max input and/or output of the device. For example, 50%FS of a 50 A sensor is 25 A, or 50% of its maximum input current. The 50% input of 25 A will cause the output to move 50%, or 50%FS. FS is used to interchangeably refer to input and output deviations when discussing input steps, fault trip thresholds and relating input to output performance. FS_{INPUT} is the input bias that results in FS_{OUTPUT} and these two are directly related by the device actual sensitivity. Both FS can be seen in Figure 7, labeled as positive or negative FS input and FS output. The equation for input referred FS for a 5 V bidirectional device is:

$$FS = V_{OOR(5V,Bi)} / Sens_{Actual} = \pm 2V / Sens_{Actual}$$

Note: that a percentage change in FS_{INPUT} is equivalent to a resultant percentage change of FS_{OUTPUT} and visa versa.

Nonlinearity (E_{LIN})

As the amount of field applied to the part changes, the sensitivity of the device can also change slightly. This is referred to as linearity error or E_{LIN} (see Figure 9). Consider two currents, I_{P1} (1/2 FS) and I_{P2} (FS). Ideally, the sensitivity of the device is the same for both fields. Linearity Error is calculated as the percent change in sensitivity from one field to another. Error is calculated separately for positive ($E_{LIN(+)}$) and negative ($E_{LIN(-)}$) currents, and the percent errors are defined as:

$$E_{LIN(\pm)} = \left(1 - \frac{Sens_{IP2\pm}}{Sens_{IP1\pm}} \right) \times 100\%$$

where:

$$Sens_{IPX+} = (V_{IOUT(IPX+)} - V_{REF}) / I_{PX+}$$

and

$$Sens_{IPX-} = (V_{IOUT(IPX-)} - V_{REF}) / I_{PX-}$$

I_{PX+} and I_{PX-} are positive and negative currents through I_P , such that $|I_{P2+}| = 2 \times |I_{P1+}|$ and $|I_{P2-}| = 2 \times |I_{P1-}|$. $E_{LIN} = \max(E_{LIN(+)}, E_{LIN(-)})$.

Total Output Error (E_{TOT})

The Total Output Error is the current measurement error from the sensor IC as a percentage of the actual applied current. This is equivalent to the difference between the ideal output voltage and the actual output voltage, divided by the ideal sensitivity, relative to the current applied to the device, or simplified to:

$$E_{TOT} = \frac{V_{IOUT(ACTUAL)} - (Sens_{(IDEAL)} \times I_{PR} + V_{REF})}{(Sens_{(IDEAL)} \times I_{PR})} \times 100$$

Total Output Error incorporates all sources of error and is a function of current. At relatively high currents, Total Output Error will be mostly due to sensitivity error, and at relatively low inputs, Total Output Error will be mostly due to Offset Voltage (V_{OE}). At $I = 0$ A, Total Output Error approaches infinity due to the offset. An example of total error at FS can be seen in Figure 9.

Note: Total Output Error goes to infinity as the amount of applied field approaches 0 A.

Power Supply Offset Error (V_{PS})

Power Supply Offset Error, V_{PS} , is defined as the offset error in mV between V_{CC} and $V_{CC} \pm 10\% V_{CC}$.

Offset Power Supply Rejection Ratio ($PSRR_O$)

The Offset Power Supply Rejection Ratio, $PSRR_O$, is defined as $20 \times \log$ of the ratio of the change of QVO in volts over a ± 100 mV variable AC V_{CC} centered at 5 V, reported as dB in a specified frequency range. This is an AC version of the V_{PS} parameter. The equation is shown below:

$$PSRR_O = 20 \log \left(\frac{\Delta QVO}{\Delta V_{CC}} \right)$$

Power Supply Sensitivity Error (E_{PS})

Power Supply Sensitivity Error, or E_{PS} , is defined as the percent sensitivity error measured between V_{CC} and $V_{CC} \pm 10\%$.

Sensitivity Power Supply Rejection Ratio ($PSRR_S$)

The Sensitivity Power Supply Rejection Ratio, $PSRR_S$, is defined as $20 \times \log$ of the ratio of the % change in sensitivity over the % change in V_{CC} (± 100 mV variable AC V_{CC} centered at 5 V), reported as dB in a specified frequency range. This is the AC version of the E_{PS} parameter. The equation is shown below:

$$PSRR_S = 20 \log \left(\frac{\Delta \% SENS}{\Delta \% V_{CC}} \right)$$

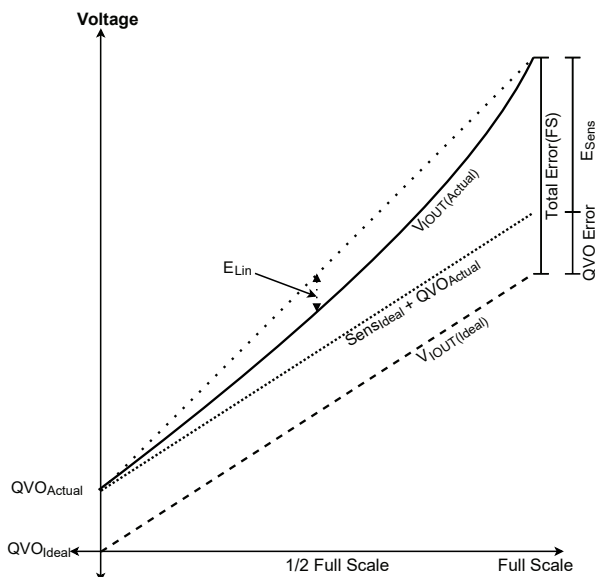

Figure 9: Accuracy Error

FAULT BEHAVIOR

Overcurrent Fault (OCF)

As the output swings, the Overcurrent Fault pin will trigger with an active low flag if the sensed current exceeds its comparator threshold. This is internally compared with either the factory-programmed thresholds or via the VOC voltage when $V_{VOC} > 0.1$ V. This flag trips symmetrically for the positive and negative OCF operating point.

The implementation for the OCF circuitry is accurate over temperature and does not require further temperature compensation as it is dependent on the Sens and V_{OFF} parameters that are factory-trimmed flat over temperature.

OVERCURRENT FAULT OPERATING RANGE/POINT (I_{OCF-OR} , I_{OCF-OP})

Overcurrent Fault Operating Range is the functional range that the OCF thresholds can be set in terms of percentage of full-scale output swing. The Overcurrent Fault Operating Point is the specific point at which the OCF trigger will occur and is set by either V_{VOC} or the factory default setting. The I_{OCF-OP} can be seen in Figure 10 as [9] along with the FAULT pin functionality.

OVERCURRENT FAULT HYSTERESIS ($I_{OCF(HYS)}$)

Overcurrent Fault Hysteresis or $I_{OCF(HYS)}$ is defined as the magnitude of percent FS that must drop before a fault assertion will be cleared. This can be seen as the separation between the voltages [9] to [10] in Figure 10. Note the MASK and HOLD functionality are independent of each other. The ACS37002LMC comes standard with an OCF_{HYS} of 120 mV (on the output) or 6%FS for a 5 V device and 9%FS for a 3.3 V device.

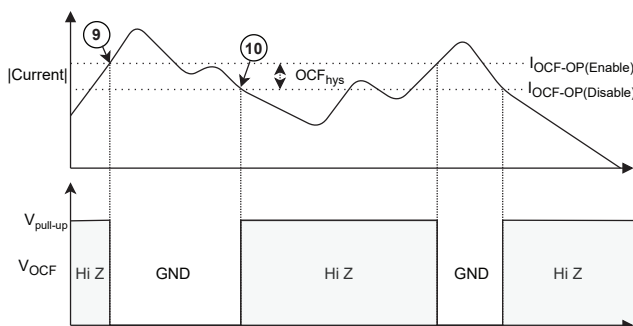

Figure 10: Fault Thresholds and OCF Pin Functionality

VOLTAGE OVERCURRENT PIN (VOC)

The Voltage Overcurrent pin, or VOC, is a voltage input that is used to set the Overcurrent FAULT Threshold, I_{OCR} . The overcurrent fault threshold, I_{OCR} , can be set using a voltage applied to the analog input VOC. For bidirectional devices, the VOC pin voltage can be set using a resistor divider from VREF.

The sensor has an internal factory-calibrated current source at VOC. Connecting a resistor between VOC and GND sets the voltage at VOC. I_{OCR} is set as a percentage of the full-scale sensing range of the device. The fault performance is valid when V_{VOC} is within the VOC operating voltage range or < 0.1 V. If the applied voltage is beyond the defined valid performance region, the device responds with varied results.

For a 5 V bidirectional device, if the VOC pin is set to 0.5 V, the minimum trip point, I_{OC_MIN} , is selected; if the VOC pin is set to 2 V, the maximum trip point, I_{OC_MAX} , is selected.

All voltages between 0.5 and 2 V for the 5 V option, and between 0.33 and 1.32 V for the 3.3 V option, can be used to linearly select a trip point between the minimum and maximum levels. When $VOC < 0.1$ V, the internal EEPROM fault level is used.

Table 1: FAULT Threshold, I_{OCR} , As Set By V_{VOC}

V_{VOC} (V)		I_{OCR} (% $I_{PR(MAX)}$)	
5 V variants	3.3 V variants	Bidirectional	Unidirectional
<0.1		100 (default)	50 (default)
0.5	0.33	50	25
0.75	0.495	75	37.5
1	0.66	100	50
1.25	0.825	125	62.5
1.5	0.99	150	75
1.75	1.155	175	87.5
2	1.32	200	100

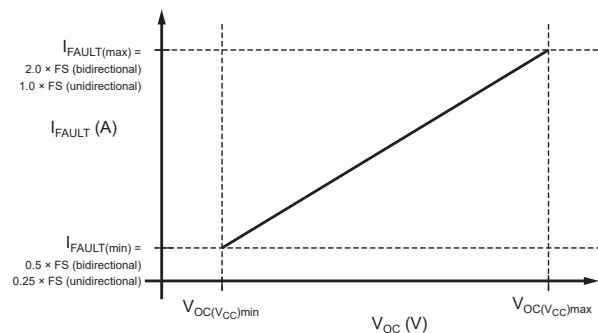

Figure 11: VOC Functional Range

OVERCURRENT FAULT ERROR (E_{OCF})

Fault Error or E_{OCF} is the error between the $I_{OCF-OP(actual)}$ and $I_{OCF-OP(ideal)}$.

OVERCURRENT FAULT RESPONSE TIME (t_{OCF})

Overcurrent Response Time or t_{OCF} is defined as the time from the input reaches the operating point [9] (seen in Figure 12) until the OCF pin falls below $V_{FAULT-ON}$ [G]. If the OCF Mask is disabled, then t_{OCF} is equal to t_{OCF-R} seen as the time from [9] until [F].

OVERCURRENT FAULT REACTION TIME (t_{OCF-R})

Overcurrent Reaction Time or t_{OCF-R} is defined as the time from the current input rising above I_{OCF-OP} at point [9] in Figure 12 until the OCF pin reaches V_{OCF-ON} at point [F] with the OCF mask disabled. This is the time required for the device to recognize and clear the fault, seen as the time between [10] until [I].

OVERCURRENT FAULT MASK TIME ($t_{OCF-MASK}$)

Overcurrent Fault Mask Time or $t_{OCF-MASK}$ is defined as the additional amount of time the OCF must be present beyond the t_{OCF-R} time (seen in Figure 12 [F] until [G]). This is to reduce nuisance tripping of the FAULT pin. If an OCF occurs, but does not persist beyond $t_{OCF-R} + t_{OCF-MASK}$, it is not reported by the device (seen in Figure 13). This prevents short transient spikes from causing erroneous OCF flagging. Factory default setting is $t_{OCF-MASK} = 0 \mu s$.

OVERCURRENT FAULT HOLD TIME ($t_{OCF-HOLD}$)

Overcurrent Fault Hold Time or $t_{OCF-HOLD}$ is defined as the minimum time OCF flag will be asserted after a sufficient OCF event. After the hold time has been reached, the OCF will release if the OCF condition has ended (seen in Figure 12 [G] until [J]) or persist if the OCF condition is still present (seen in Figure 14 [G] until [J]). Factory default is 0 ms.

OVERCURRENT FAULT PERSIST

The ACS37002LMC has a fault persist option that will maintain the OCF flag if a flag occurred until a POR event.

OCF DISABLE

The ACS37002LMC has the ability to disable overcurrent fault functionality; when this is disabled, the OCF pin will remain in high impedance.

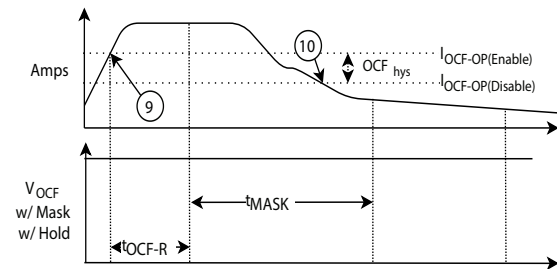

Figure 13: Fault Condition Clearing Before Mask Time Is Reached

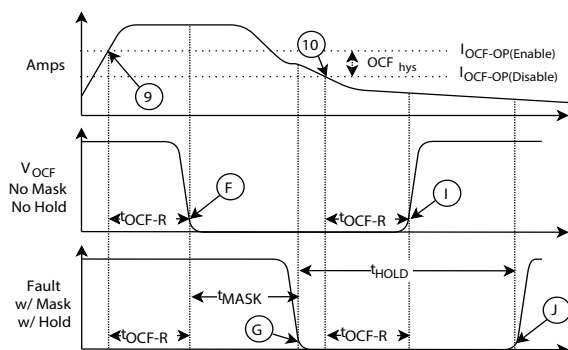

Figure 12: General Fault Timing.
Note: the MASK and HOLD functionality are independent of each other

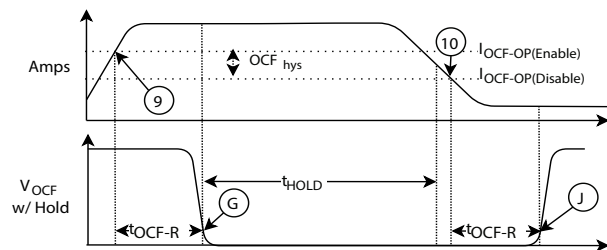

Figure 14: Fault Hold with Clear Fault After Hold Time

DYNAMIC RESPONSE PARAMETERS

The descriptions in this section use the listed test conditions and assume a temperature of 25°C. The step applied is a input step that corresponds to 1 V deviation on the output, unless otherwise stated.

Propagation Time (t_{PD})

The time interval between a) when the sensed current reaches 10% of its stable value, and b) when the sensor output reaches 10% of its stable value for a step input. See Figure 15.

Rise Time (t_r)

The time interval between a) when the sensor reaches 10% of its stable value, and b) when it reaches 90% of the stable value for a step input. See Figure 15.

Response Time ($t_{RESPONSE}$)

The time interval between a) when the sensed current reaches 90% of its stable value, and b) when the sensor output reaches 90% of its stable value. See Figure 15.

Temperature Compensation

To help compensate for the effects temperature has on performance, the ACS37002LMC has an integrated internal temperature sensor. This sensor and compensation algorithms help to standardize device performance over the full range of optimized temperatures. This allows for room temperature system calibration and validation of end-of-line modules.

Temperature Compensation Update Rate

There is an 8 ms update time that is required to maintain a valid temperature compensated output; that is, temperature compensations are calculated and applied every 8 ms.

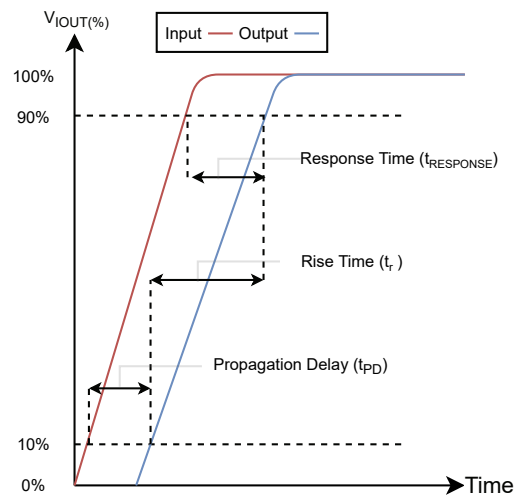

Figure 15: Dynamic Response Parameters

APPLICATION AND THEORY

Application Circuits

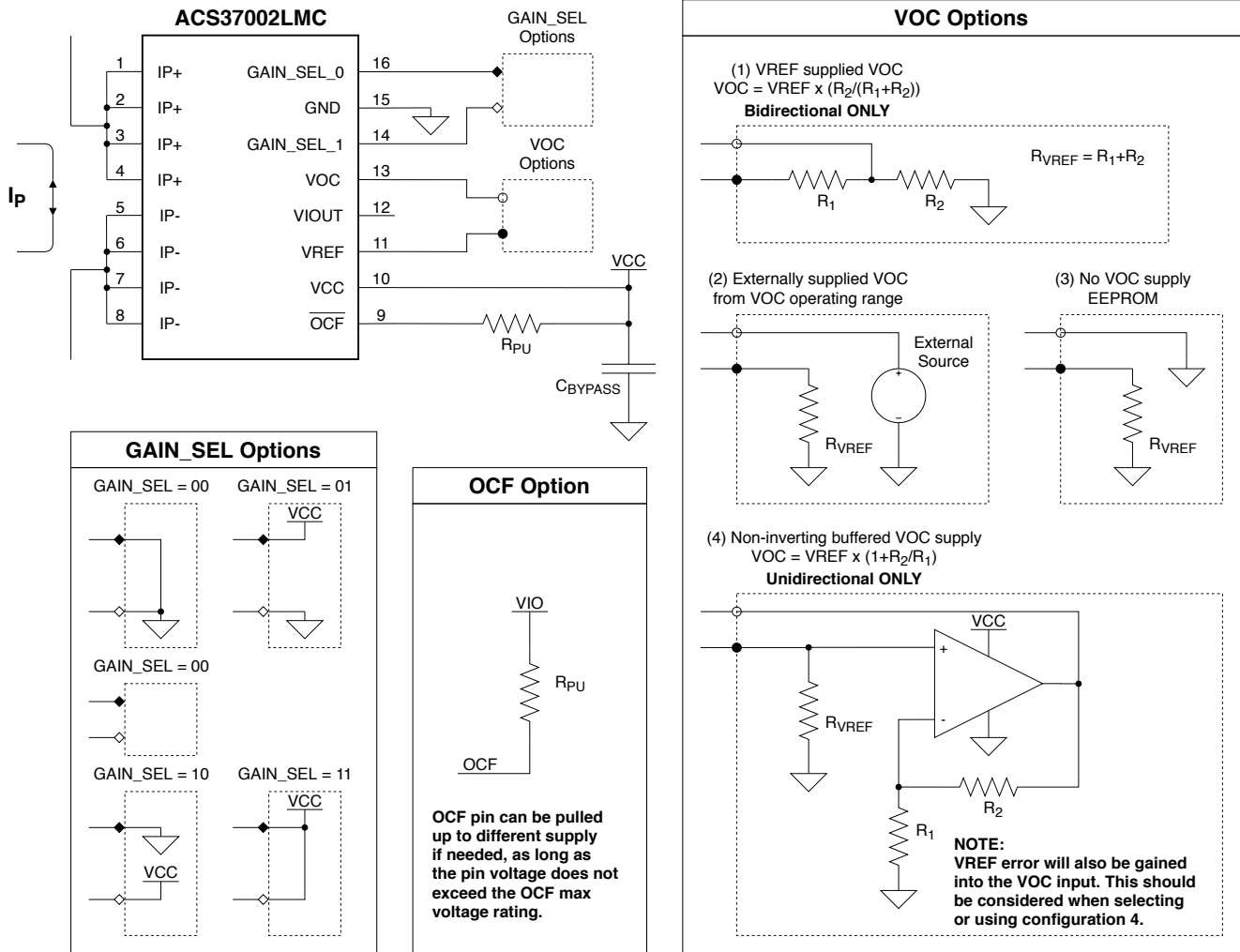

Figure 16: Applications Circuits for GAIN_SEL, VOC, and FAULT pin

These configurations are simplified to the network required for functionality.

Bypass and load capacitors are recommended for best performance.

Theory and Functionality – VOC and OCF

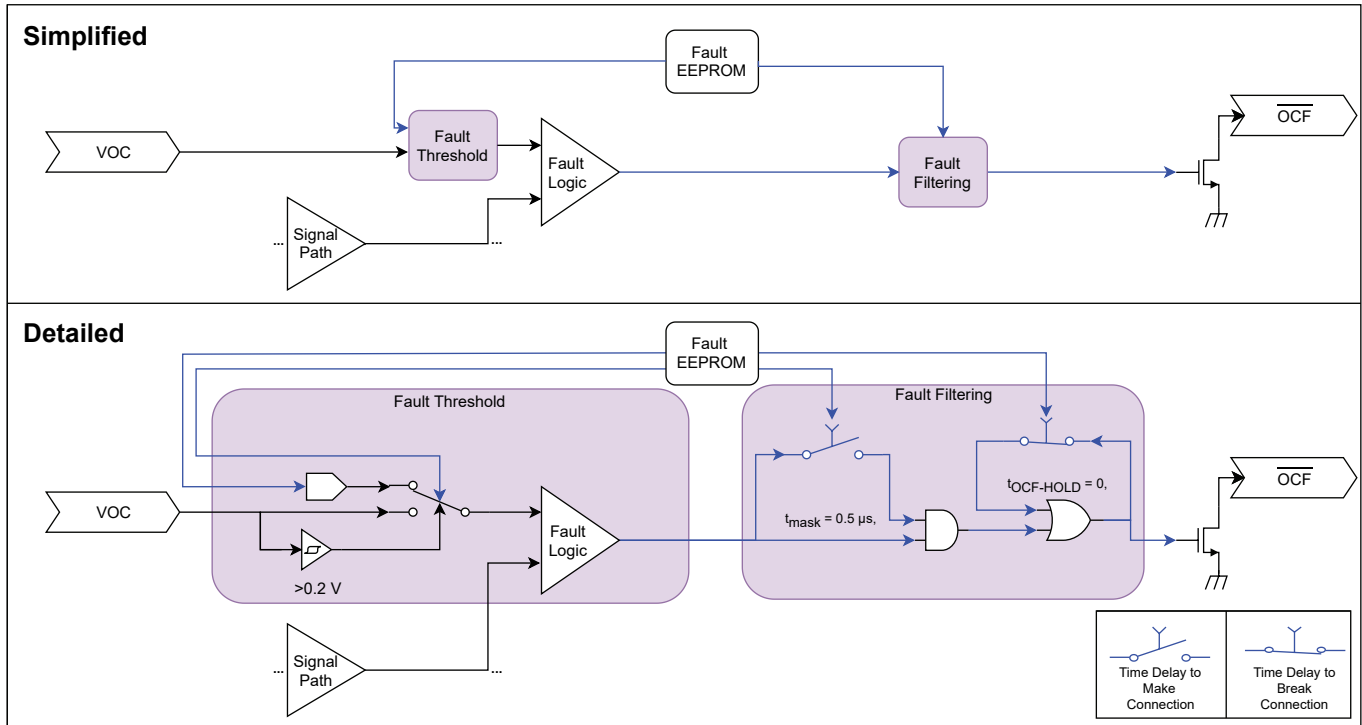

Figure 17: OCF Signal Path Simplified and Detailed Blocks of Functionality

VOC DRIVEN BY NON-INVERTING BUFFERED VREF

If the VOC pin is being driven by a non-inverted buffered V_{REF} , it is important to consider that any error from the V_{REF} pin will be gained as well. For instance, if V_{REF} error is +10 mV and the gain = 4 for the non-inverting operational amplifier, then the VOC pin will be 40 mV from the expected target. For unidirectional devices, OCF would be subjected to an additional 4% error due to the error propagation from V_{REF} through the gain stage.

POWER SUPPLY DECOUPLING CAPACITOR AND OUTPUT CAPACITIVE LOADS

The higher the capacitive load on the outputs (V_{REF} , V_{IOUT}), the larger the decoupling capacitor should be on the power supply (V_{CC}) to maintain performance.

C_{LOAD}	C_{BYPASS}
0 nF	100 nF
1 nF	>100 nF
3 nF	>1 μF
6 nF	>10 μF

Dynamically Change Gain in a System

The ACS37002LMC has GAIN_SEL pins that are used to change the gain of the device on startup. If a more dynamic gain is desired, then reduce V_{CC} below $V_{POR(L)}$ and restart the device by returning V_{CC} to the nominal voltage with the new desired GAIN_SEL configuration. The GAIN_SEL pin voltage

must be greater than the desired configuration voltage ($V_{H(SEL)}$ or $V_{L(SEL)}$) at or before $V_{CC} > V_{POR(H)}$ in order to successfully change the device gain. The GAIN_SEL pin voltage is latched at startup, and any changes to the pin voltages after the device's V_{IOUT} comes out of high impedance will not affect gain. The cycle time to complete this operation is up to $2 \times t_{POD}$.

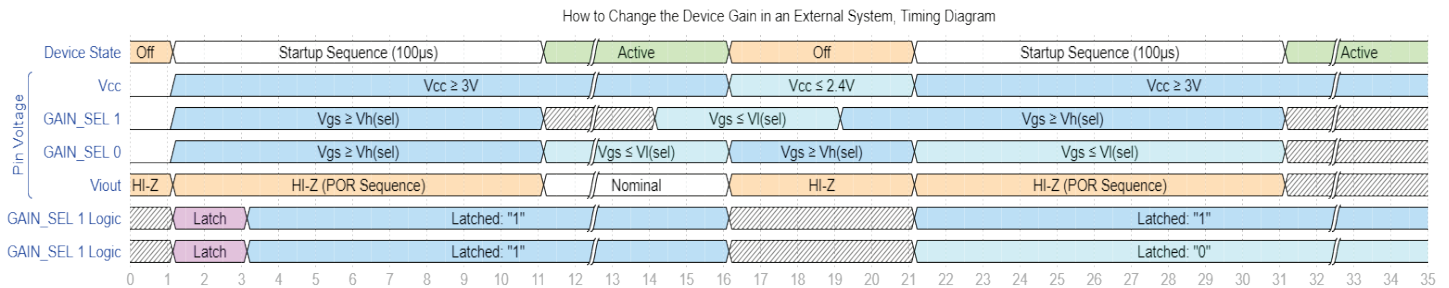

Figure 18: GAIN_SEL Dynamic Gain Changing Timing Diagram

APPLICATION INFORMATION

Thermal Rise vs. Primary Current

Self-heating due to the flow of current should be considered during the design of any current sensing system. The sensor, printed circuit board (PCB), and contacts to the PCB will generate heat as current moves through the system.

The thermal response is highly dependent on PCB layout, copper thickness, cooling techniques, and the profile of the injected current. The current profile includes peak current, current “on-time”, and duty cycle. While the data presented in this section was collected with direct current (DC), these numbers may be used to approximate thermal response for both AC signals and current pulses.

The plot in Figure 19 shows the measured rise in steady-state die temperature of the ACS37002LMC versus continuous current at an ambient temperature, T_A , of 25 °C. The thermal offset curves may be directly applied to other values of T_A . Conversely, Figure 20 shows the maximum continuous current at a given T_A . Surges beyond the maximum current listed in Figure 20 are allowed given the maximum junction temperature, $T_{J(MAX)}$ (165°C), is not exceeded.

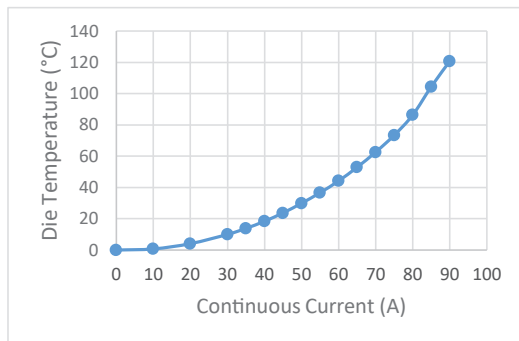

Figure 19: Self-heating in the MC package due to current flow

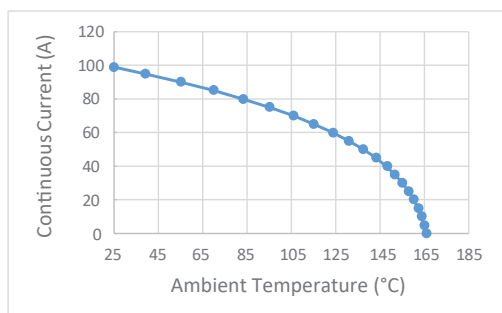

Figure 20: Maximum continuous current at a given T_A

The thermal capacity of the ACS37002LMC should be verified by the end user. The maximum junction temperature, $T_{J(MAX)}$, should not be exceeded. Further information on this application testing is available in the [DC and Transient Current Capability](#) application note on the Allegro website.

ASEK37002MC Evaluation Board Layout

Thermal data shown in Figure 19 and Figure 20 was collected using the ASEK37002MC Evaluation Board (TED-0003299). This board includes 750 mm² of 4 oz. (0.1388 mm) copper connected to pins 1 through 4, and to pins 5 through 8, with thermal vias connecting the layers. Top and bottom layers of the PCB are shown below in Figure 21.

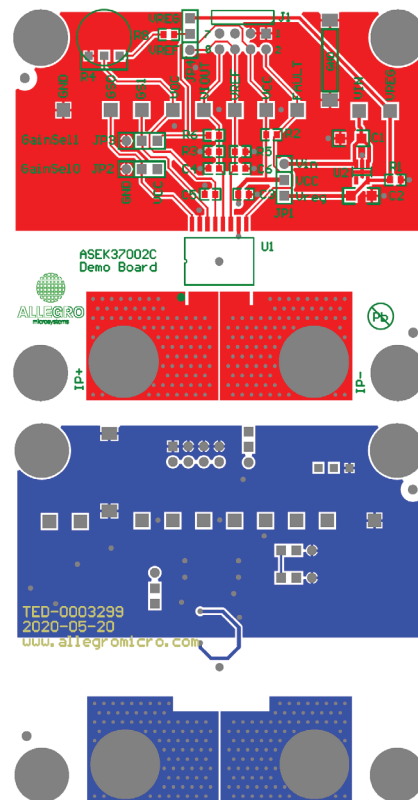

Figure 21: Top and bottom layers for ASEK37002MC evaluation board

Gerber files for the ASEK37002MC evaluation board are available for download from the Allegro website. See the technical documents section of the ACS37002LMC device [webpage](#).

PACKAGE OUTLINE DRAWING

For Reference Only; Not for Tooling Use

(reference DWG-0000714, Rev. 2)

Dimensions in millimeters

Dimensions exclusive of mold flash, gate burrs, and dambar protrusions
Exact case and lead configuration at supplier discretion within limits shown

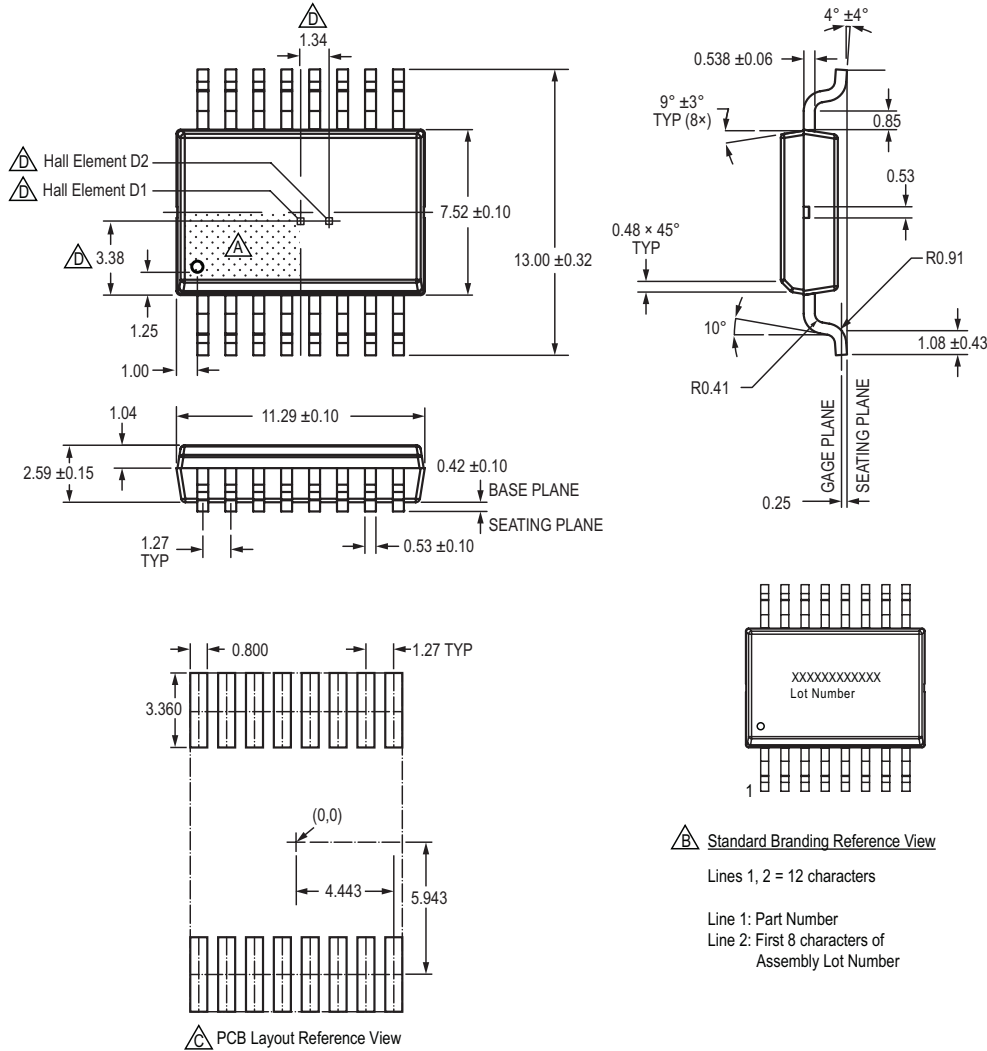

Standard Branding Reference View

Lines 1, 2 = 12 characters

Line 1: Part Number

Line 2: First 8 characters of Assembly Lot Number

- △ Terminal #1 mark area
- △ Branding scale and appearance at supplier discretion
- △ Reference land pattern layout; all pads a minimum of 0.20 mm from all adjacent pads; adjust as necessary to meet application process requirements and PCB layout tolerances; when mounting on a multilayer PCB, thermal vias at the exposed thermal pad land can improve thermal dissipation (reference EIA/JEDEC Standard JESD51-5)
- △ Hall elements D1, D2 (not to scale)

Figure 22: Package MC, 16-Pin SOICW

Revision History

Number	Date	Description
–	December 14, 2020	Initial release
1	December 7, 2021	Added RoHs compliance note (page 1); updated Figure 1 caption (page 1); updated naming convention (page 2); removed RoHS and Pb free symbols (page 2); added MSL rating to the Isolation and Package Characteristics table (page 4); added Output Buffer Resistance to the Common Electrical Characteristics table (page 7); added Typical Frequency Response (page 15); updated Figure 12, Figure 13, Figure 14 (page 23); updated Figure 17 (page 26); added Thermal Application Section (page 28); minor editorial updates (all pages)
2	January 11, 2022	Updated package drawing (page 29)
3	August 29, 2023	Added ACS37002LMCATR-066B3 and ACS37002LMCATR-090B3 part variants (all pages); removed footnote 2 from Selection Guide (page 2)
4	December 1, 2023	Updated Isolation Characteristics table (page 4), added Thermal Characteristics table (page 4), and corrected part numbering (pages 11 and 14–16)
5	February 1, 2024	Added Hall elements to Package Outline Drawing (page 31)
6	July 10, 2024	Updated Isolation Characteristics table (page 4)
7	August 14, 2025	Updated Power Supply Offset Error and Power Supply Sensitivity Error test conditions (page 8)
8	January 15, 2026	Added Zero Current Reference Voltage characteristic for 3.3 V unidirectional variant (page 9); moved ACS37002LMCATR-050U5, removed ACS37002LMCATR-090B3, and added ACS37002LMCATR-066U3 (pages 2, 11, 13, 16); modified Voltage Overcurrent Pin description (page 25); and made minor editorial corrections (pages 1, 11–17, 24)

Copyright 2026 Allegro MicroSystems.

Allegro MicroSystems reserves the right to make, from time to time, such departures from the detail specifications as may be required to permit improvements in the performance, reliability, or manufacturability of its products. Before placing an order, the user is cautioned to verify that the information being relied upon is current.

Allegro's products are not to be used in any devices or systems, including but not limited to life support devices or systems, in which a failure of Allegro's product can reasonably be expected to cause bodily harm.

The information included herein is believed to be accurate and reliable. However, Allegro MicroSystems assumes no responsibility for its use; nor for any infringement of patents or other rights of third parties which may result from its use.

Copies of this document are considered uncontrolled documents.

For the latest version of this document, visit our website:

www.allegromicro.com