

修订	标记	修改摘要	签名	日期
REV	MARK	REVISION DESCRIPTION	SIGNATURE	DATE
AD		NEW DRG		2016-03-12

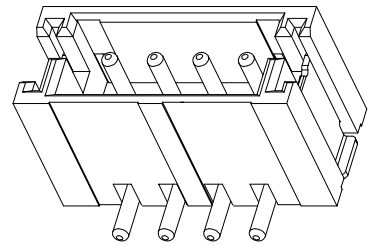

- 技术指标:
1. 塑件表面应光洁、无毛边、无明显收缩、缺陷、裂纹等现象.
 2. 温度范围: $-25^{\circ}\text{C} \sim 85^{\circ}\text{C}$.
 3. 额定电压: 50V, AC/DC.
 4. 接触电阻: $\leq 30\text{m}\Omega$.
 5. 绝缘电阻: $\geq 500\text{M}\Omega$.
 6. 额定电流: 1A, AC/DC.

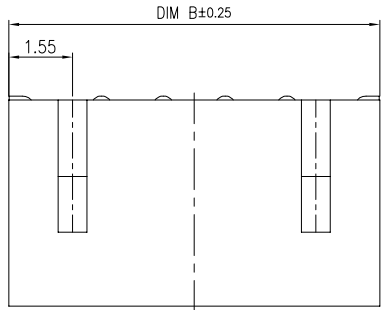
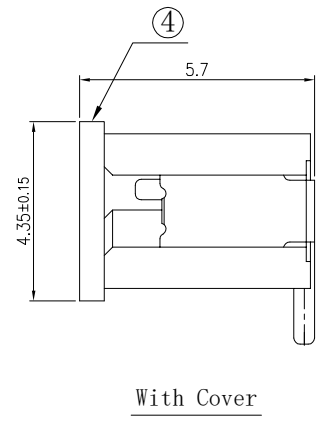
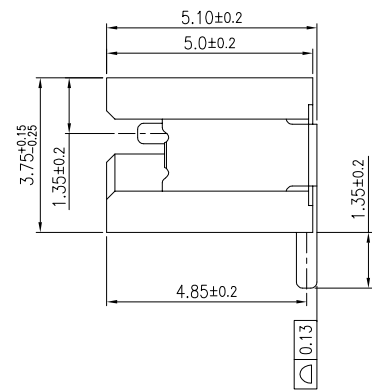
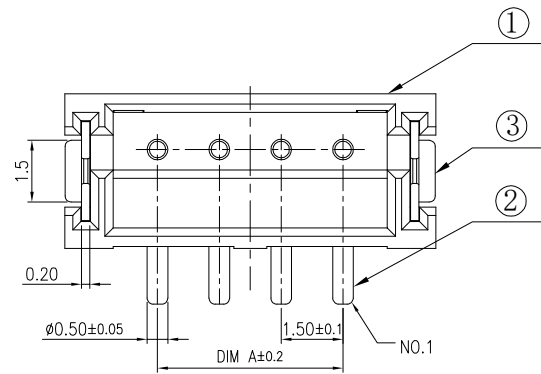

CKT	Dim A	Dim B
2	1.50	6.00
3	3.00	7.50
4	4.50	9.00
5	6.00	10.50
6	7.50	12.50
7	9.00	13.50
8	10.50	15.50
9	12.50	16.50
10	13.50	18.50
11	15.50	19.50
12	16.50	21.50
13	18.50	22.50
14	19.50	24.50
15	21.50	25.50
16	22.50	27.50
17	24.50	28.50
18	25.50	30.00
19	27.50	31.50
20	28.50	33.00

序号	项目	描述	备注
1	塑胶	LCP	
2	铜针	黄铜	
3	焊片	磷铜	
4	盖子		

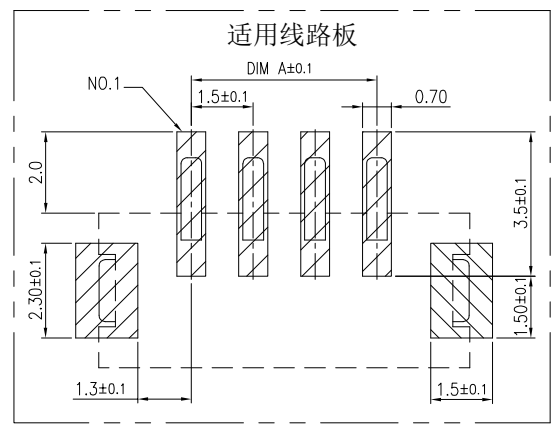



深圳市华德共创科技有限公司
Shenzhen Huade co-create Technology Co., LTD
电话: 0755-27111216 传真: 0755-29940187

-TOLERANCES- UNLESS OTHERWISE SPECIFIED 公差参数表		TITLE: 产品名称: ZH1.50mm立式 SMT	
X.X	±0.30	X.X*	±3°
X.XX	±0.20	X.XX*	±2°
X.XXX	±0.10	X.XXX*	±1°
APPD: 核准:	王建国	PART NO: 产品编号:	1.5K-BH-nPB
CHECK: 校对:	黄艳兰	DATE	SCALE UNIT CODE NUMBER
DRAW: 绘图:	2016-03-12	1:1	mm A001