

SPECIFICATION

1. Rating : DC 50V 0.5A.
2. Function: 1P2T
3. Contact resistance: $\leq 100m\Omega$.
4. Insulation resistance: $\geq 100M\Omega$ (DC500V).
5. Withstanding voltage: 500VAC .
6. Operating Force: $250\pm 100gf$.
7. life test: 10,000 cycles.
8. Operation temperature range: $-25^{\circ}C\sim 85^{\circ}C$.
9. Sign"* "is importance dimension.

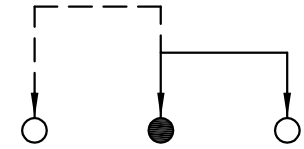

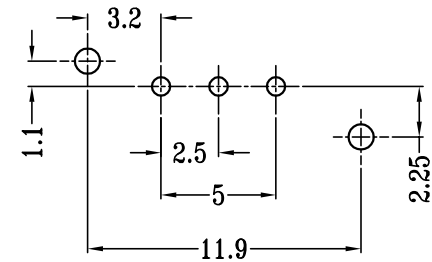
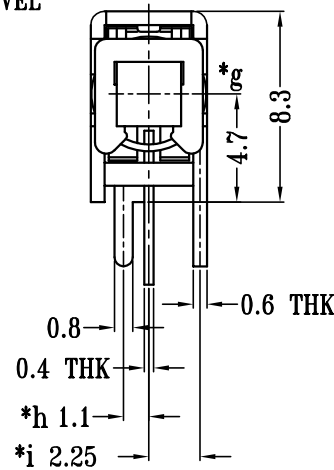
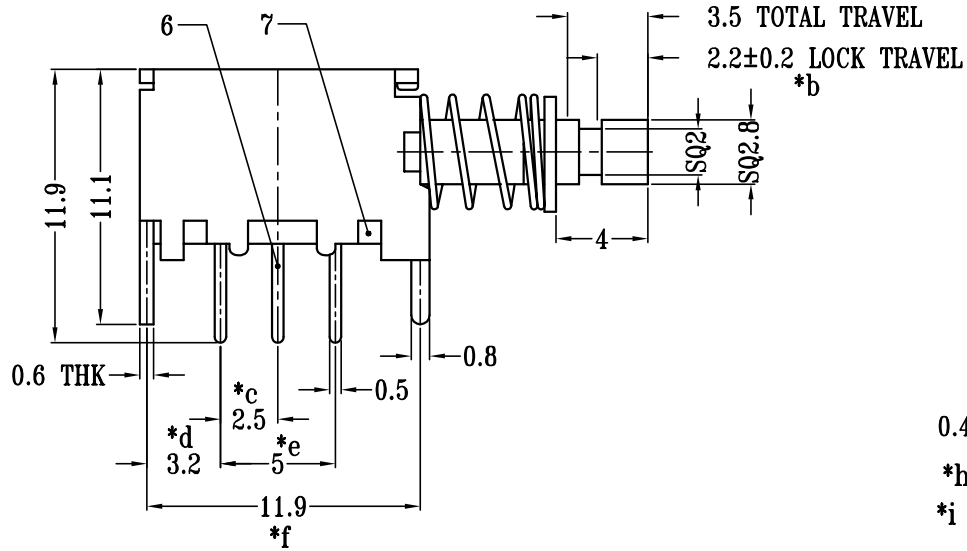

SCHEMATIC (NON-SHORTING)



P.C.B LAYOUT
BOTTOM VIEW

9	CONTACT CLIP	PBS C5210R-EH	1	Ag CLAD
8	SPRING PLATE	PBS STRIP	1	NATURAL
7	BASE	PHENOLIC RESIN	1	NATURAL
6	TERMINAL	BRASS STRIP	3	Ag PLATED
5	KNOB	PA66	1	BLUE
4	BLOCK	STEEL STRIP	1	Ni PLATED
3	SPRING	STEEL WIRE	1	Ni PLATED
2	CAM STICK	PBS WIRE	1	Ni PLATED
1	FRAME	STEEL STRIP	1	Ni PLATED
NO.	PART NAME	MATERIAL	QTY	FINISHING

TOLERANCE UNLESS SPECIFIED <1.5: $\pm 0.1mm$ >1.5~5.0: $\pm 0.25mm$ >5.0: $\pm 0.3mm$		ANGULAR $\pm 1^{\circ}$	AO	2025.07.04	首次发行	LP
			NO	DATE	REVISIONS	BY
TITLE: PUSH SWITCH			UNIT : MM	ROHS COMPLIANT	DWN	
MODEL: PS-12E05-S-L			SCALE: 1:1	CHK'D		
 DONGGUANG HAOYU ELECTRONICS CO., LTD 皓宇 HOOYA 东莞市弘皓电子有限公司			APPD			
			PRO.AGL:			REV :AO