

### FEATURES

- Both the DTC144E chip and DTA144E chip in a package
- Mounting possible with SOT-363 automatic mounting machines
- Transistor elements are independent, eliminating interference
- Mounting cost and area be cut in half

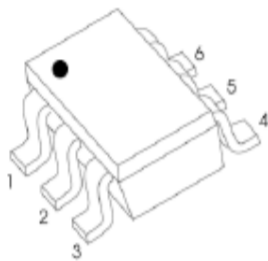

SOT-363

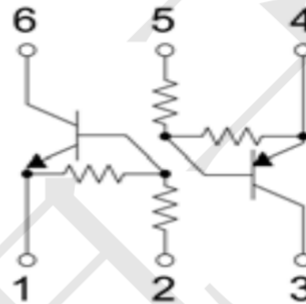

### T<sub>R1</sub> Absolute maximum ratings (Ta=25°C)

Parameter	Symbol	Value	Unit
Supply voltage	V <sub>CC</sub>	50	V
Input voltage	V <sub>IN</sub>	-10~+40	V
Output current	I <sub>O</sub>	30	mA
	I <sub>C(MAX)</sub>	100	
Power dissipation	Pd	150	mW
Operation Junction and Storage Temperature Range	T <sub>J</sub> , T <sub>stg</sub>	-55~+150	°C

### T<sub>R1</sub> Electrical characteristics (Ta=25°C)

Parameter	Symbol	Min.	Typ	Max.	Unit	Conditions
Input voltage	V <sub>I(off)</sub>	0.5			V	V <sub>CC</sub> =5V, I <sub>O</sub> =100μA
	V <sub>I(on)</sub>			3		V <sub>O</sub> =0.3V, I <sub>O</sub> =2mA
Output voltage	V <sub>O(on)</sub>		0.1	0.3	V	I <sub>O</sub> /I <sub>I</sub> =10mA/0.5mA
Input current	I <sub>I</sub>			0.18	mA	V <sub>I</sub> =5V
Output current	I <sub>O(off)</sub>			0.5	μA	V <sub>CC</sub> =50V, V <sub>I</sub> =0
DC current gain	G <sub>I</sub>	68				V <sub>O</sub> =5V, I <sub>O</sub> =5mA
Input resistance	R <sub>1</sub>	32.9	47	61.1	KΩ	-
Resistance ratio	R <sub>2</sub> /R <sub>1</sub>	0.8	1	1.2		-
Transition frequency	f <sub>T</sub>		250		MHz	V <sub>CE</sub> =10V, I <sub>E</sub> =-5mA, f=100MHz

**T<sub>R2</sub> Absolute maximum ratings (Ta=25°C)**

Parameter	Symbol	Value	Unit
Supply voltage	V <sub>CC</sub>	-50	V
Input voltage	V <sub>IN</sub>	-40~+10	V
Output current	I <sub>O</sub>	-30	mA
	I <sub>C(MAX)</sub>	-100	
Power dissipation	Pd	150	mW
Operation Junction and Storage Temperature Range	T <sub>J</sub> , T <sub>stg</sub>	-55~+150	°C

**T<sub>R2</sub> Electrical characteristics (Ta=25°C)**

Parameter	Symbol	Min.	Typ	Max.	Unit	Conditions
Input voltage	V <sub>I(off)</sub>	-0.5			V	V <sub>CC</sub> =-5V, I <sub>O</sub> =-100μA
	V <sub>I(on)</sub>			-3		V <sub>O</sub> =-0.3V, I <sub>O</sub> =-2mA
Output voltage	V <sub>O(on)</sub>		-0.1	-0.3	V	I <sub>O</sub> /I <sub>I</sub> =-10mA/-0.5mA
Input current	I <sub>I</sub>			-0.18	mA	V <sub>I</sub> =-5V
Output current	I <sub>O(off)</sub>			-0.5	μA	V <sub>CC</sub> =-50V, V <sub>I</sub> =0
DC current gain	G <sub>I</sub>	68				V <sub>O</sub> =-5V, I <sub>O</sub> =-5mA
Input resistance	R <sub>1</sub>	32.9	47	61.1	KΩ	-
Resistance ratio	R <sub>2</sub> /R <sub>1</sub>	0.8	1	1.2		-
Transition frequency	f <sub>T</sub>		250		MHz	V <sub>CE</sub> =-10V, I <sub>E</sub> =5mA, f=100MHz

### Typical Characteristics

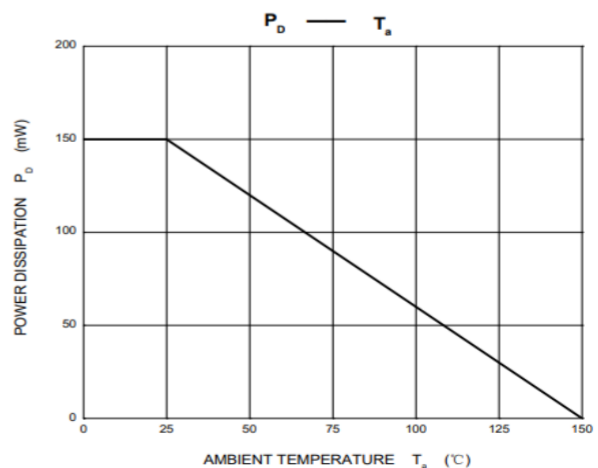
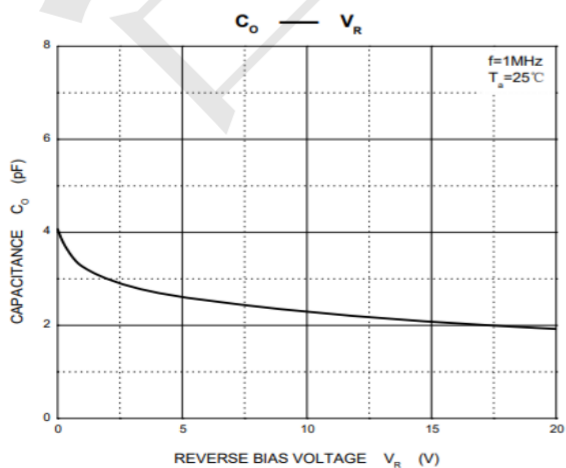
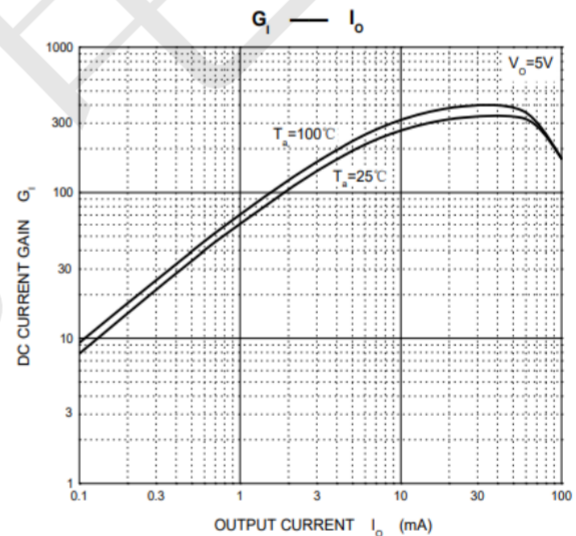
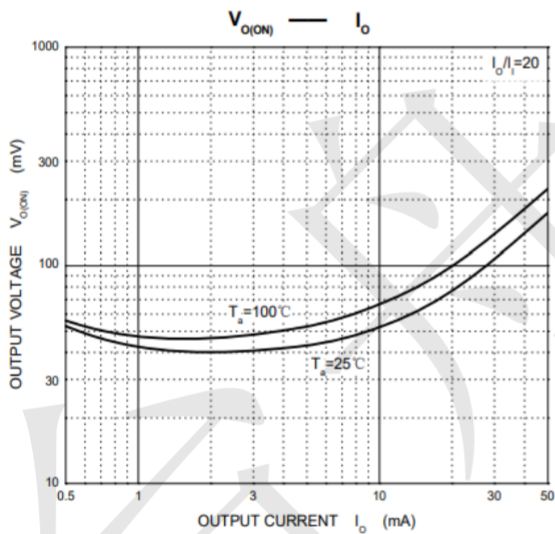
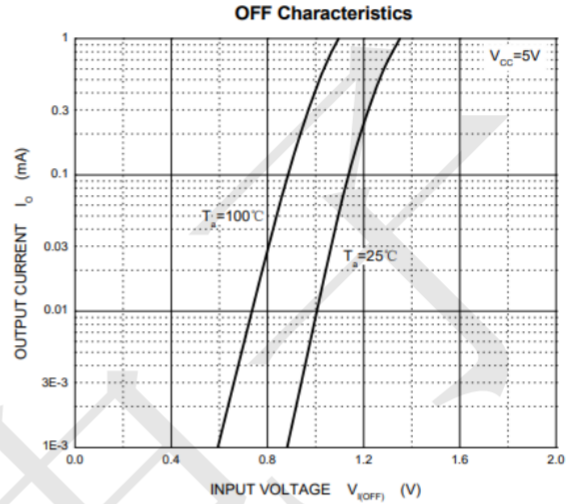
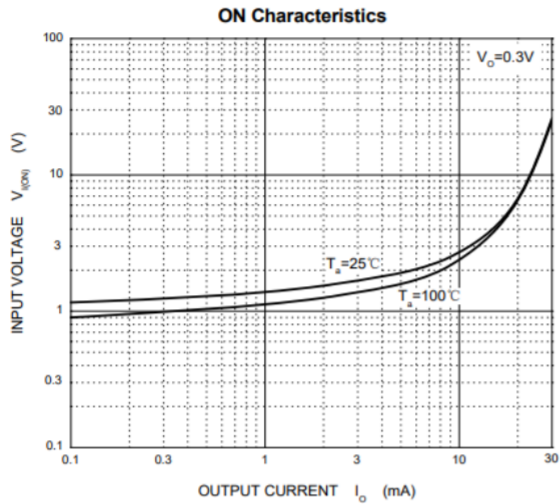

### Typical Characteristics

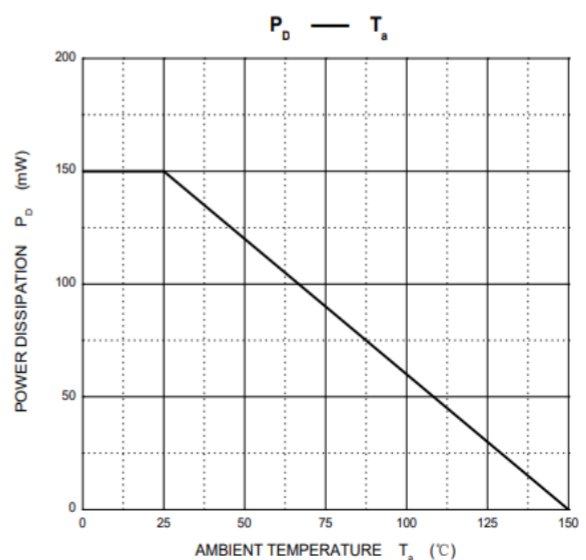
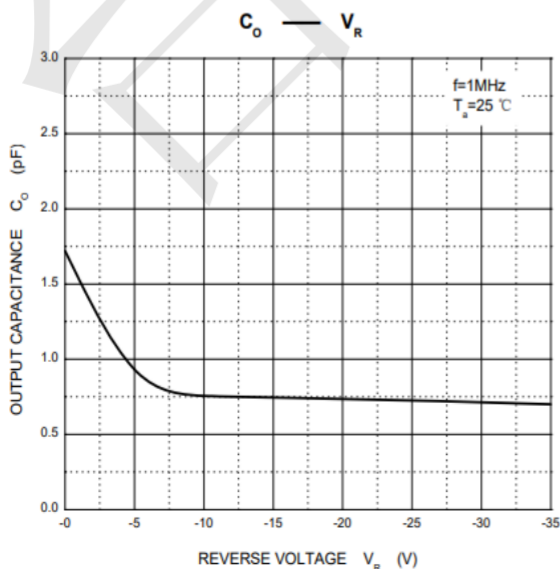
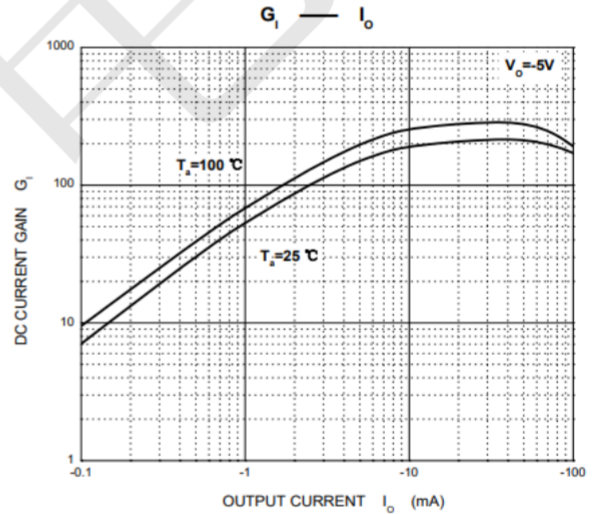
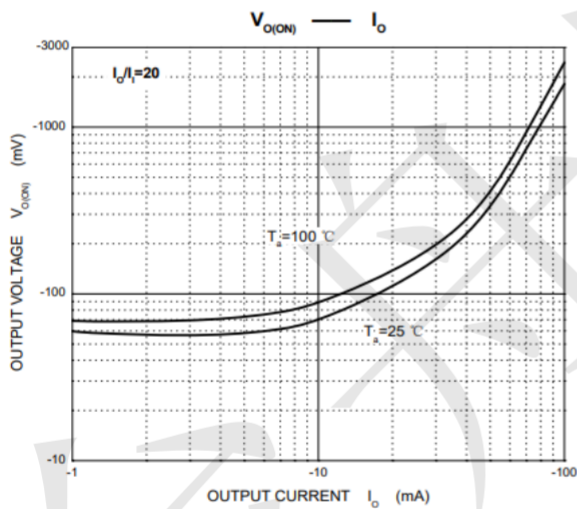
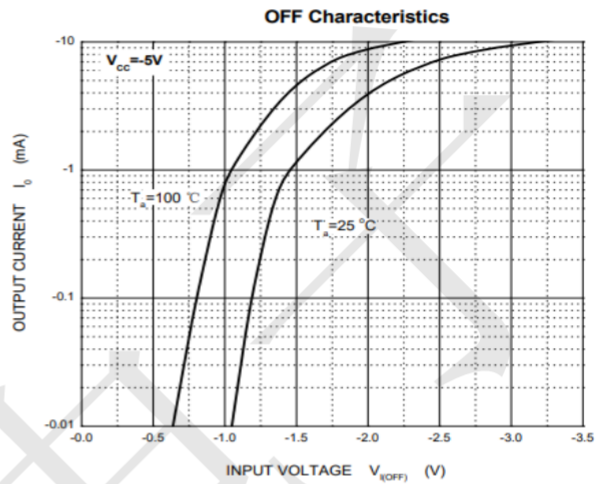
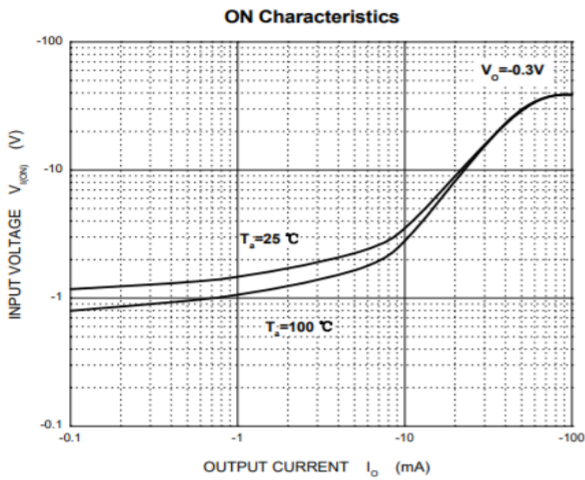

Package information (Unit: mm)

SOT-363

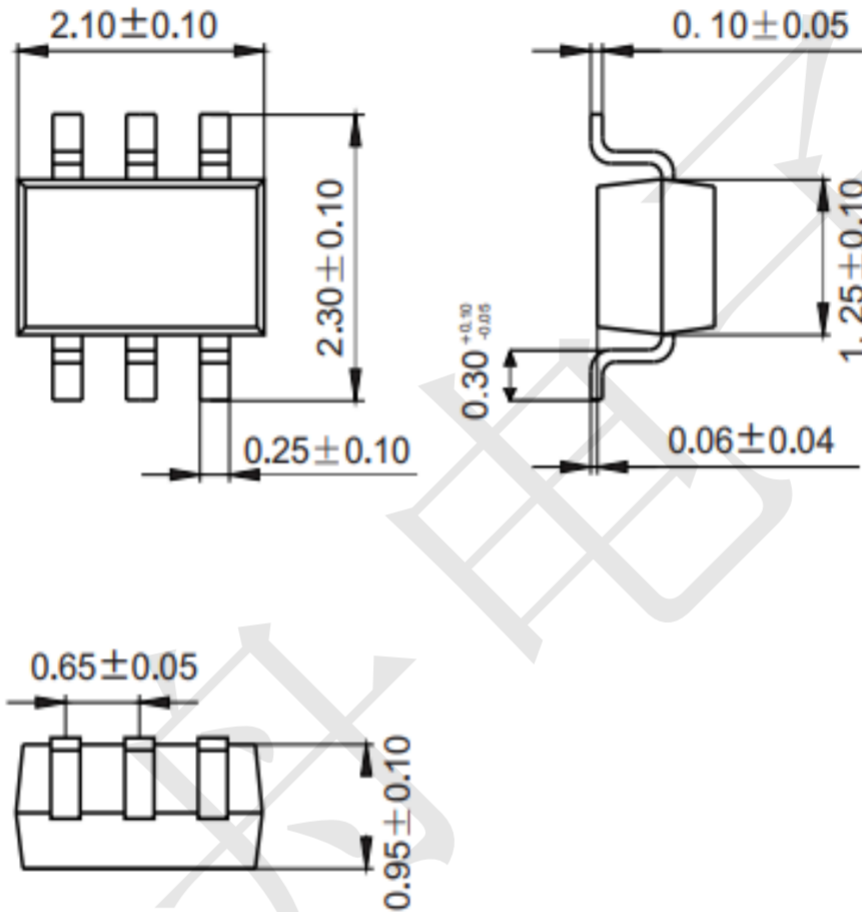

Mounting Pad Layout (Unit: mm)

