

STANDARD SPECIFICATION

产品规格书

客户 Customer: _____

客户料号 Customer P/N NO.: _____

产品描述 Product Description: TCXO-3225 32.000MHZ 1.8~3.3V ±0.5PPM
H X - C 料号 P/N. NO.: 3T032000VX

客户批准 Customer Approval :

审 核	批 准
Checked	APPROVED

(请批准后回签一份 PLEASE RETURN A COPY WITH APPROVAL)

拟 制 DESIGNER	审 核 CHECK	批 准 APPROVED
万力阳	蔡勤	柯建平

地址: 深圳市龙华区龙胜路融创智汇大厦C座1401-1402室

Office add: Room 1401-1402, Building C, Rongchuang, Longhua District, shenzhen

TEL: 0755-21044642



1. 石英晶体参数规格 QUARTZ CRYSTAL UNIT SPECIFICATION

描述 Description : TCXO
 产品型别 Product Type : 3T
 测量设备 Measure equipment : S&A 280B
 电气特性 Electrical Characteristics

NO.	项目 Item	符号 Symbol	电气特性规格 Electrical Specification				备注 Notes
			下限 Min.	中心 Typ.	上限 Max.	单位 Units	
1	标准频率 Nominal Frequency	FL	32.000			MHZ	
2	输出方式 Output mode	-	Clipped Sinewave			-	
3	频率偏差 Frequency Tolerance	FT	-0.5	-	0.5	ppm	
4	温度频率稳定性 Temperature frequency stability	TC	-1.5	-	1.5	ppm	T _A =25°C, V _{CC} =3.3V
5	工作温度 Operating Temperature		-40	-	85	°C	
6	储存温度范围 Storage Temperature	T _{stg}	-40	-	125	°C	
7	老化率 Aging rate	F _{age}		±1		ppm	First year
8	供电电压 For the pressure	V _{dd}	1.8~3.3±5%			V	
9	电流 current	I _{cc}			1.5	mA	
10	启动时间 Start-up time	T _{o's'c}			3	ms	More then 90%of final amplitude
11	输出电平 Output Level	-	0.8	-	-	V _{p-p}	Clipped sine wave(DC-coupled)
11	占空比 Duty ratio	TH/T	40	-	60	%	
12	负载变化 Load Variation	-	-	-	±0.2	ppm	Load_R//C=(10kΩ//10pF)±10%
相位噪声 Phase noise			-120dBc/Hz 100Hz offset	-140dBc/Hz 1KHz offset	-150dBc/Hz 10KHz offset	-155dBc/Hz 100KHz offset	

2. 电路测试 CILCUIT TEST

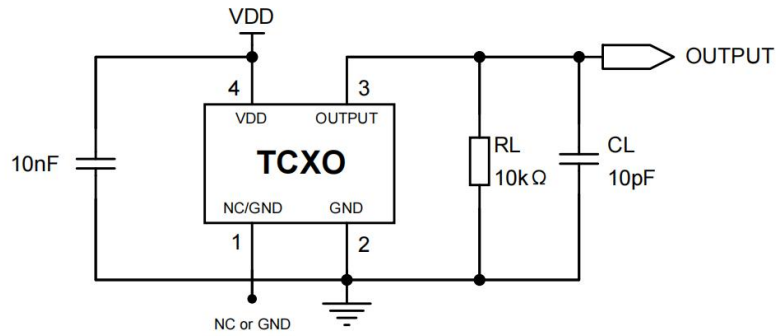

DC Coupled Application

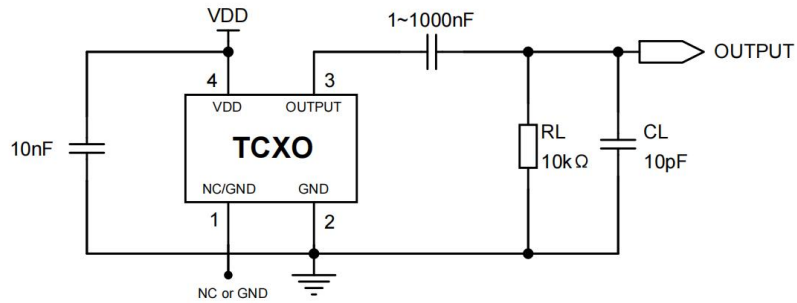

AC Coupled Application

3. 包装数量 NUMBER OF PACKAGES

类型 TYPE	尺寸 SIZE	数量 NUMBER
包装盒 Packaging	180*20*180	3000pcs
包装箱 Packing cases	240*200*200	30000pcs

4. 外形尺寸 BOUNDARY DIMENSION

(单位: mm)

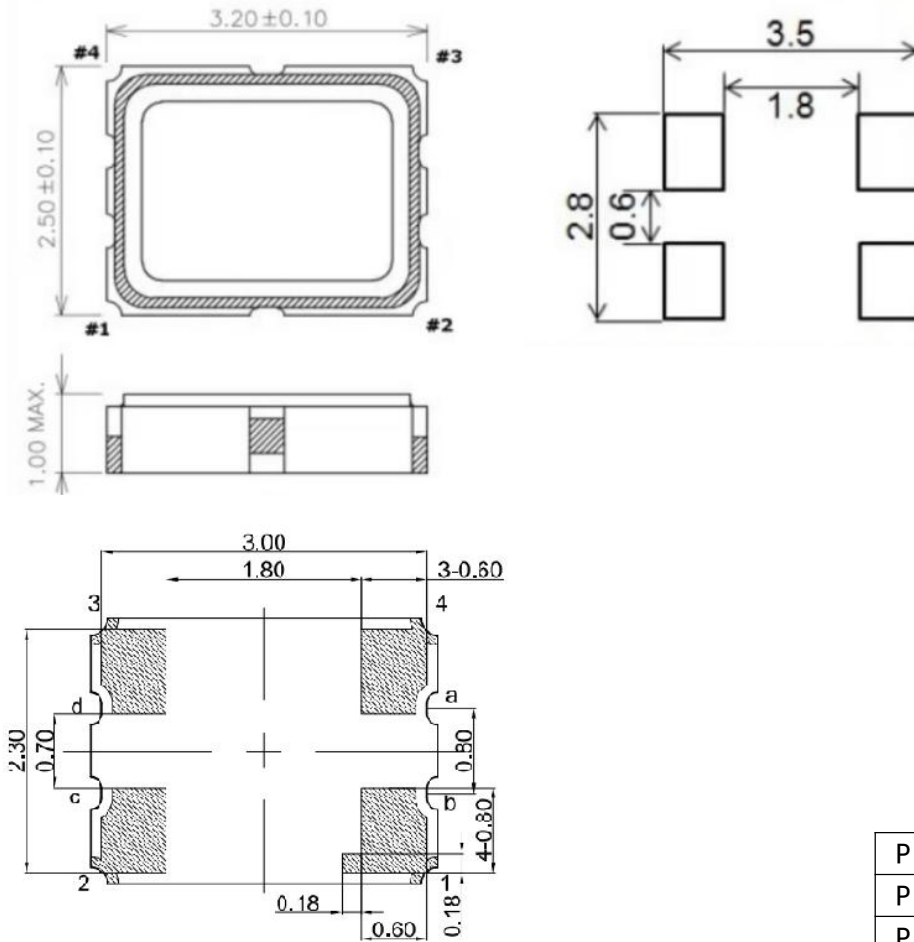

Pin 1	NC or GND
Pin 2	GND
Pin 3	OUTPUT
Pin 4	VDD

5. 印字



HX-C ----- LOGO
32.0 ----- 频率
V ----- 电压
* ----- 周期
. ----- Pin1

6. 编带包装 BRAID PACKAGING

(单位: mm)

1. 载带与编带盘尺寸

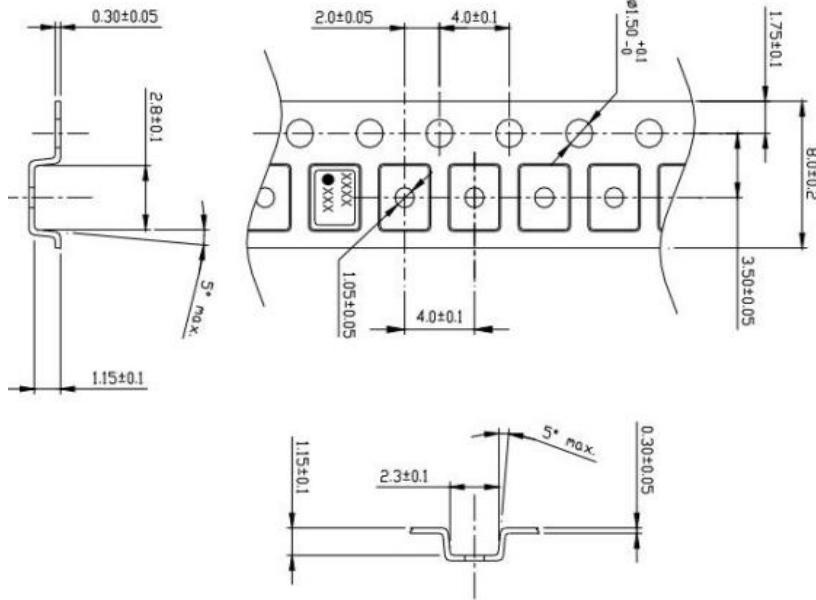

1. Clearance of an embossing tape, and a product unit: mm

Direction	Pocket size	TCXO size	Clearance
L	2.8±0.1	2.5±0.15	0.3±0.25
W	2.3±0.1	2.0±0.15	0.3±0.25
H	1.15±0.1	0.9 max.	0.25 min.

2. Quality : Polystyrene (Conductivity)

3. Tensile strength of an embossing tape : more than 14N

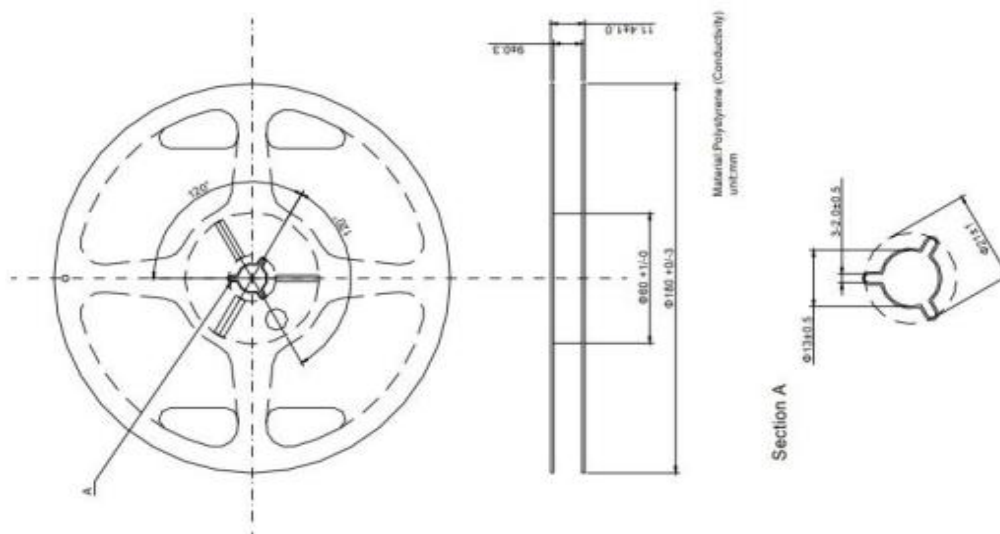

7. 回流焊温度曲线 REFLOW PROFILES

参考标准 REFER: JEDEC J-STD-020D

Profiles Feature	Pb-Free Assembly
Preheat/Soak Temperature Min (Ts min) Temperature Max (Ts max) Time (Ts) from (Ts min to Ts max)	150°C 200°C 60-120 seconds
Ramp-up rate (TL to TP)	3°C/second max.
Liquidous temperature (TL) Time (TL) maintained above TL	217°C 60-150 seconds
Peak/Classification Temperature (TP)	260±5°C
Time within 5°C of actual Peak Temperature (TP)	20~40 seconds
Ramp-down rate (TP to TL)	6°C/second max.
Time 25 °C to peak temperature	8 minutes max.
Suggest reflow times	3 Times max

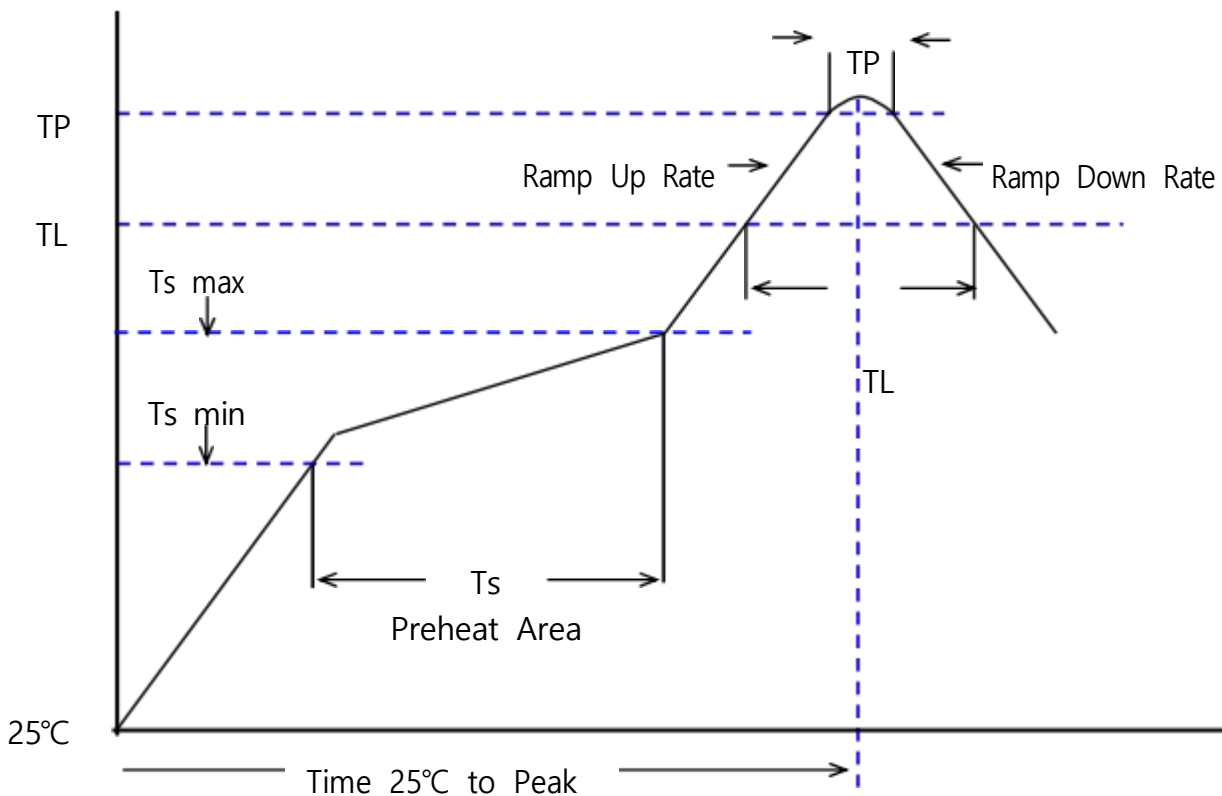

8. 可靠性试验 RELIABILITY SPECIFICATION

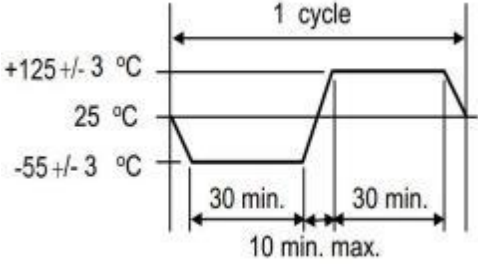
参考标准REFER		JIS C 6701	
NO.	项目 ITEM	测试条件 CONDITIONS	判定标准 Criteria
1	跌落 FREE FALL	从150cm位置高度,自由跌落在木板上,连续3次. FREE DROPPING FROM 150 cm HEIGHT 3 TIMES ON A HARD	电器性能 满足规格要求 THE ELECTRICAL PERFORMAN CE MEET THESPECIFIC ATONN
2	振动 VIBRATION	振动频率： 10~2000 Hz， 振幅： 1.52mm， 时间： 每个方位三面 (X、Y、Z) 各振动2小时 FREQUENCY： 10.2000Hz;AMPLITUDE (TOTAL EXCURSION)： 1.5mm SWEEP TIME： 2-3MIN, 3 DIRECTION(X, Y, Z) EACH FOR 2 Hrs.	
3	温度循环 TEMPERATURE CYCLE	晶体放入试验箱中， 高、低温循环10次 THE CRYSTAL UNIT SHALL BE SUBJECTED TO 10 SUCCESSIVE CHANGE OF TEMPERATURE CYCLE 	
4	冲击 IMOACT	半正弦波冲击 (1000G)： 持续时间： 0.5ms， X,Y,Z三轴各三次时间： 2 小时 HELIUM BOMBING: 3 TIME	
5	可焊性 SOLDERABILI TY	温度： 245±5°C， 浸锡时间： 3±0.5 秒 THE LEAD IS IMMERSIED IN A 245±5°C SOLDER BATH WITHIN 3±0.5 SECONDS.	
6	稳态湿热 HIGH TEMP. & HUMIDITY	温度： 85 ±3°C， 湿度： 85 %， 保持时间： 500个小时 STORED AT 85 ±3°C AND HUMIDITY 85 % FOR 500±12H.	
7	高温存储 HIGH TEMPERATURE STORAGE	高温温度： 125±2°C， 时间： 500±12 个小时 STORED AT 125±2°C FOR 500±12H. 如果客户的温度要求是高于标准,则必须根据客户的要求测试 If Customer's temperature request is higher than the standard, Temperature test must be done for customer requirements	
8	低温存储 LOW TEMPERATURE STORAGE	低温温度： -40±2°C， 时间： 500±12 个小时 STORED AT -40±2°C FOR 500±12H. 如果客户的温度要求是低于标准,则必须根据客户的要求测试 If Customer's temperature request is lower than the standard, Temperature test must be done for customer requirements	