

Description:

This N-Channel MOSFET uses advanced trench technology and design to provide excellent $R_{DS(on)}$ with low gate charge.

It can be used in a wide variety of applications.

Features:

- 1) $V_{DS}=60V, I_D=4A, R_{DS(ON)}<80m\ \Omega @V_{GS}=10V$
- 2) Low gate charge.
- 3) Green device available.
- 4) Advanced high cell density trench technology for ultra low $R_{DS(ON)}$.
- 5) Excellent package for good heat dissipation.

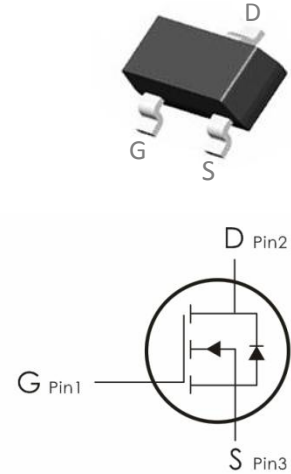

Package Marking and Ordering Information:

Part NO.	Marking	Package	Packing
DO2310AA	2310A	SOT-23-3	3000 pcs/Reel

Absolute Maximum Ratings: ($T_A=25^\circ\text{C}$ unless otherwise noted)

Symbol	Parameter	Ratings	Units
V_{DS}	Drain-Source Voltage	60	V
V_{GS}	Gate-Source Voltage	± 20	V
I_D	Continuous Drain Current	4	A
I_{DM}	Pulsed Drain Current ¹	15.8	
P_D	Power Dissipation	1.46	W
T_J, T_{STG}	Operating and Storage Junction Temperature Range	-55-+150	$^\circ\text{C}$

Thermal Characteristics:

Symbol	Parameter	Max	Units
$R_{\theta JA}$	Thermal Resistance, Junction to Ambient ²	85	$^\circ\text{C}/\text{W}$

Electrical Characteristics: ($T_A=25^{\circ}\text{C}$ unless otherwise noted)

Symbol	Parameter	Conditions	Min	Typ	Max	Units
Off Characteristics						
BV_{DSS}	Drain-Source Breakdown Voltage	$V_{GS}=0V, I_D=250\ \mu\text{A}$	60	---	---	V
I_{DSS}	Zero Gate Voltage Drain Current	$V_{GS}=0V, V_{DS}=60V$	---	---	1	μA
I_{GSS}	Gate-Source Leakage Current	$V_{GS}=\pm 20V, V_{DS}=0A$	---	---	± 100	nA
On Characteristics						
$V_{GS(th)}$	GATE-Source Threshold Voltage	$V_{GS}=V_{DS}, I_D=250\ \mu\text{A}$	1	1.6	2.5	V
$R_{DS(on)}$	Drain-Source On Resistance ³	$V_{GS}=10V, I_D=2A$	---	60	80	$\text{m}\Omega$
		$V_{GS}=4.5V, I_D=1.5A$	---	70	90	$\text{m}\Omega$
Dynamic Characteristics						
C_{iss}	Input Capacitance	$V_{DS}=25V, V_{GS}=0V, f=1\text{MHz}$	---	410	---	pF
C_{oss}	Output Capacitance		---	36	--	
C_{rss}	Reverse Transfer Capacitance		---	34	---	
Switching Characteristics						
$t_{d(on)}$	Turn-On Delay Time	$V_{DS}=30V, I_D=2A,$ $R_{ENG}=3\ \Omega, V_{GS}=10V$	---	5.7	---	ns
t_r	Rise Time		---	11.5	---	ns
$t_{d(off)}$	Turn-Off Delay Time		---	12	---	ns
t_f	Fall Time		---	7.6	---	ns
Q_g	Total Gate Charge	$V_{GS}=10V, V_{DS}=30V,$ $I_D=3A$	---	14.3	---	nc
Q_{gs}	Gate-Source Charge		---	2.9	---	nc
Q_{gd}	Gate-Drain "Miller" Charge		---	2.4	---	nc
Drain-Source Diode Characteristics						
V_{SD}	Diode Forward Voltage ³	$V_{GS}=0V, I_{SD}=2A$	---	---	1.2	V
I_S	Continuous Drain Current	$V_D=V_G=0V$	---	---	4	A
I_{SM}	Pulsed Drain Current		---	---	15.8	A

Notes:

1. Repetitive Rating: Pulse Width Limited by Maximum Junction Temperature.
2. $R_{\theta JA}$ is measured with the device mounted on a 1inch² pad of 2oz copper FR4 PCB
3. Pulse Test: Pulse Width $\leq 300\mu s$, Duty Cycle $\leq 0.5\%$.

Typical Characteristics: ($T_A=25^\circ C$ unless otherwise noted)

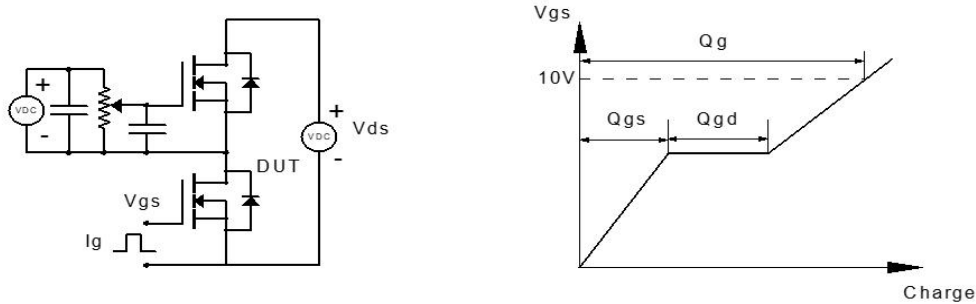

Figure 1: Gate Charge Test Circuit & Waveform

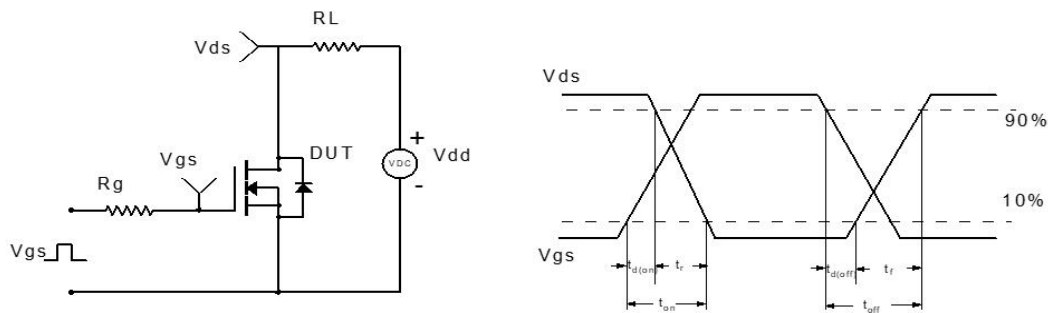

Figure 2: Resistive Switching Test Circuit & Waveform

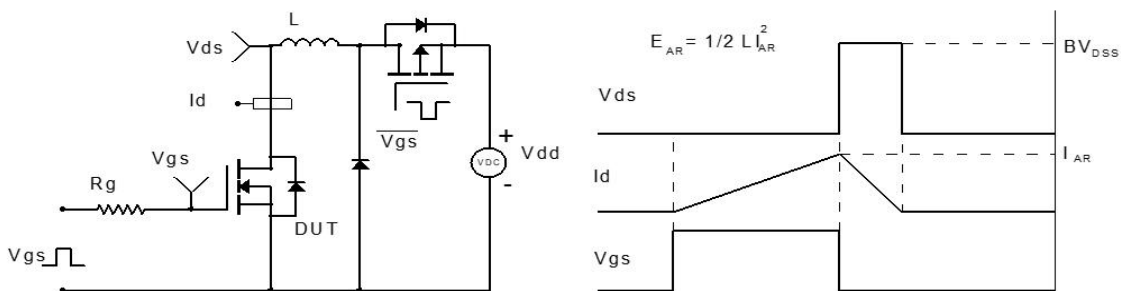

Figure 3: Unclamped Inductive Switching Test Circuit & Waveform

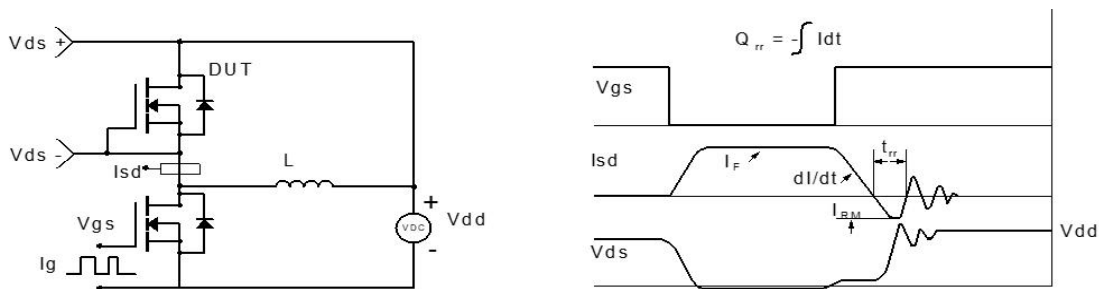
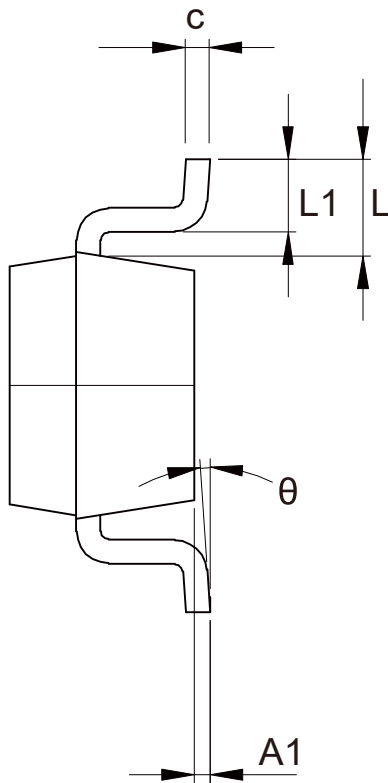
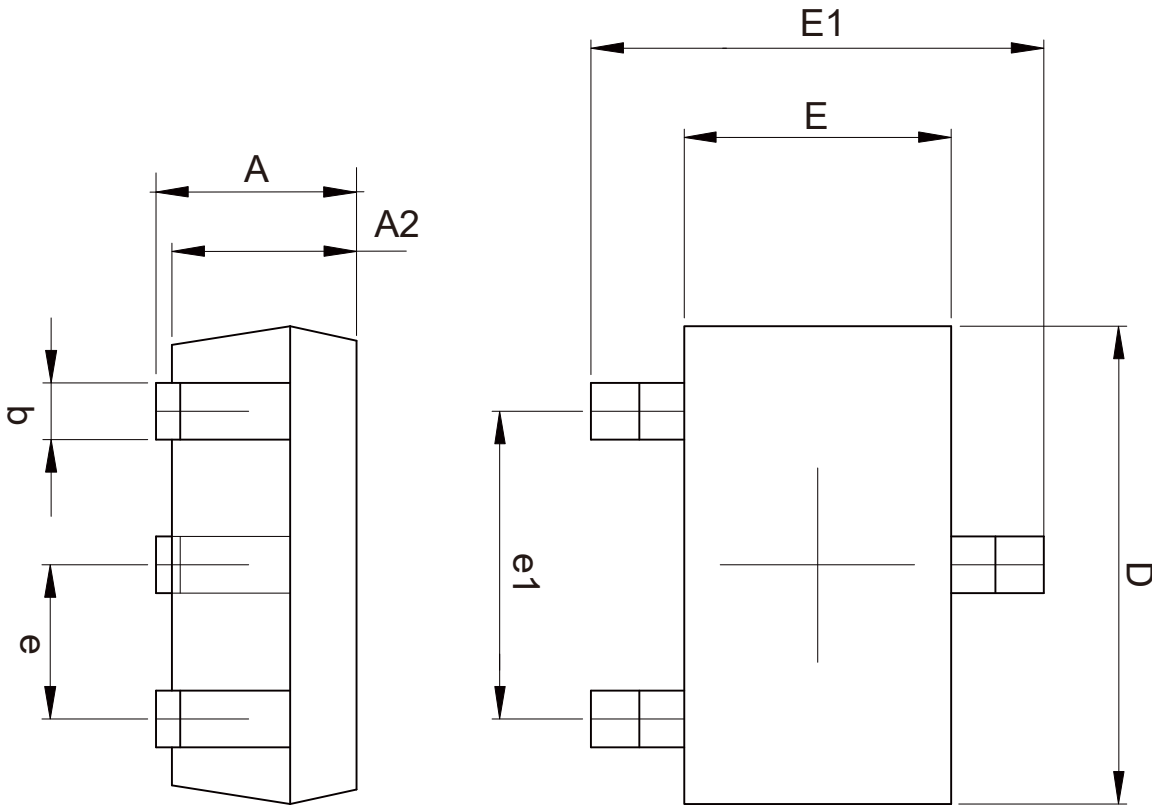

Figure 4: Diode Recovery Test Circuit & Waveform

SOT-23-3 Package Outline Data



COMMON DIMENSIONS			
CUNITS MEASURE=MILLIMETER			
SYMBOL	MIN	NOM	MAX
A	1.050	---	1.300
A1	0.000	---	0.200
A2	1.050	---	1.200
b	0.300	0.400	0.500
c	0.100	---	0.200
D	2.820	2.900	3.020
E	1.500	1.600	1.700
E1	2.650	2.800	2.950
e	0.950TYP		
e1	1.800	1.900	2.000
L	0.6REF		
L1	0.300	0.450	0.600
θ	0°	--	8°

Unit:mm

Marking Information:

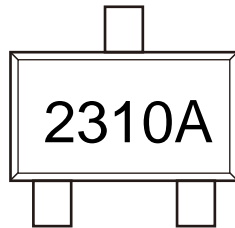

Attention :

- Information furnished in this document is believed to be accurate and reliable. However, Shenzhen Doingter Semiconductor Co.,Ltd. assumes no responsibility for the consequences of use without consideration for such information nor use beyond it.
- Information mentioned in this document is subject to change without notice, apart from that when an agreement is signed, Shenzhen Doingter complies with the agreement. Products and information provided in this document have no infringement of patents.
- Shenzhen Doingter assumes no responsibility for any infringement of other rights of third parties which may result from the use of such products and information. This

document supersedes and replaces all information previously supplied.



Is

a registered trademark of Shenzhen Doingter Semiconductor Co., Ltd. Copyright © 2013

Shenzhen Doingter Semiconductor Co.,Ltd. Printed All rights reserved.