

FEATURES

- Both the DTC144E chip and DTA144E chip in a package
- Mounting possible with SOT-363 automatic mounting machines
- Transistor elements are independent, eliminating interference
- Mounting cost and area be cut in half

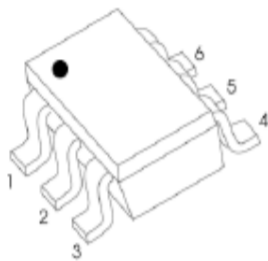

SOT-363

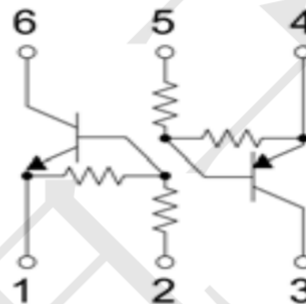

T_{R1} Absolute maximum ratings (Ta=25°C)

Parameter	Symbol	Value	Unit
Supply voltage	V _{CC}	50	V
Input voltage	V _{IN}	-10~+40	V
Output current	I _O	30	mA
	I _{C(MAX)}	100	
Power dissipation	Pd	150	mW
Operation Junction and Storage Temperature Range	T _J , T _{stg}	-55~+150	°C

T_{R1} Electrical characteristics (Ta=25°C)

Parameter	Symbol	Min.	Typ	Max.	Unit	Conditions
Input voltage	V _{I(off)}	0.5			V	V _{CC} =5V, I _O =100μA
	V _{I(on)}			3		V _O =0.3V, I _O =2mA
Output voltage	V _{O(on)}		0.1	0.3	V	I _O /I _I =10mA/0.5mA
Input current	I _I			0.18	mA	V _I =5V
Output current	I _{O(off)}			0.5	μA	V _{CC} =50V, V _I =0
DC current gain	G _I	68				V _O =5V, I _O =5mA
Input resistance	R ₁	32.9	47	61.1	KΩ	-
Resistance ratio	R ₂ /R ₁	0.8	1	1.2		-
Transition frequency	f _T		250		MHz	V _{CE} =10V, I _E =-5mA, f=100MHz

T_{R2} Absolute maximum ratings (Ta=25°C)

Parameter	Symbol	Value	Unit
Supply voltage	V _{CC}	-50	V
Input voltage	V _{IN}	-40~+10	V
Output current	I _O	-30	mA
	I _{C(MAX)}	-100	
Power dissipation	P _d	150	mW
Operation Junction and Storage Temperature Range	T _J , T _{stg}	-55~+150	°C

T_{R2} Electrical characteristics (Ta=25°C)

Parameter	Symbol	Min.	Typ	Max.	Unit	Conditions
Input voltage	V _{I(off)}	-0.5			V	V _{CC} =-5V, I _O =-100μA
	V _{I(on)}			-3		V _O =-0.3V, I _O =-2mA
Output voltage	V _{O(on)}		-0.1	-0.3	V	I _O /I _I =-10mA/-0.5mA
Input current	I _I			-0.18	mA	V _I =-5V
Output current	I _{O(off)}			-0.5	μA	V _{CC} =-50V, V _I =0
DC current gain	G _I	68				V _O =-5V, I _O =-5mA
Input resistance	R ₁	32.9	47	61.1	KΩ	-
Resistance ratio	R ₂ /R ₁	0.8	1	1.2		-
Transition frequency	f _T		250		MHz	V _{CE} =-10V, I _E =5mA, f=100MHz

Typical Characteristics

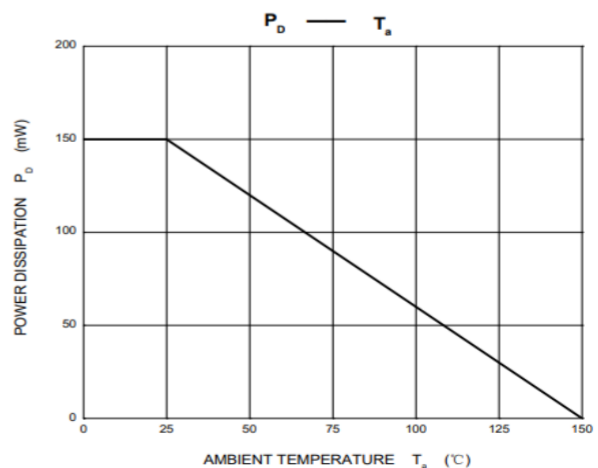
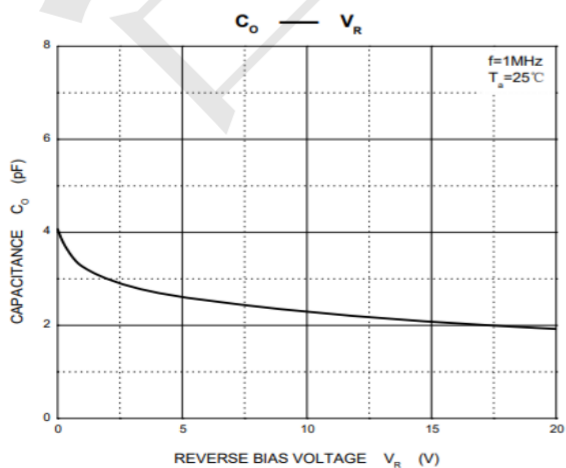
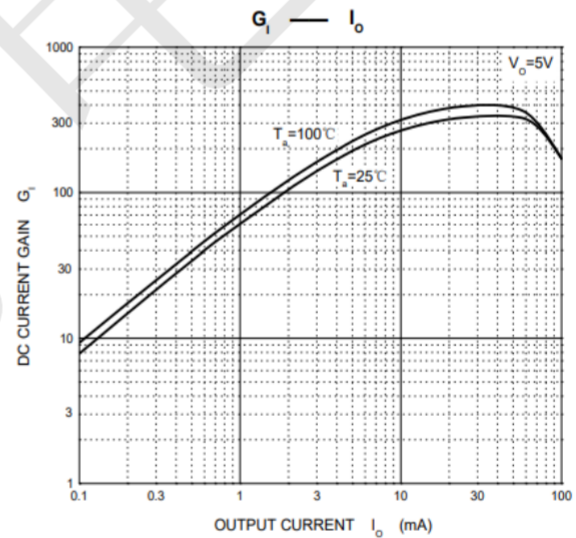
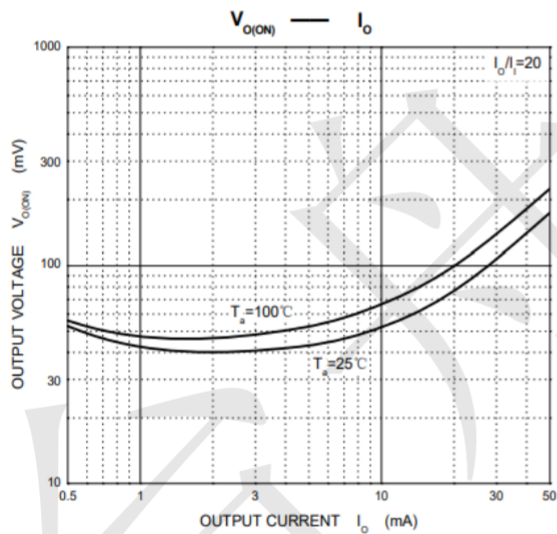
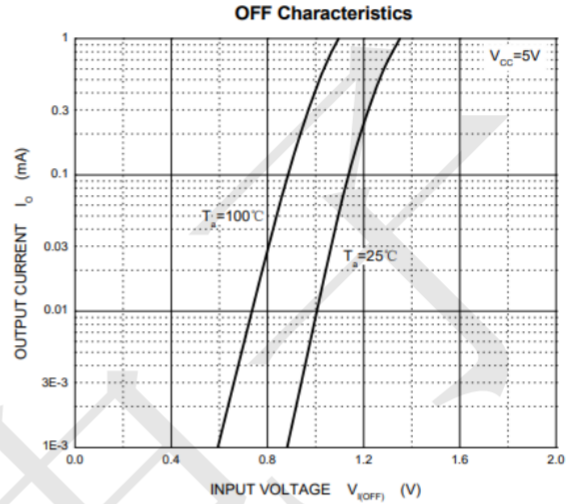
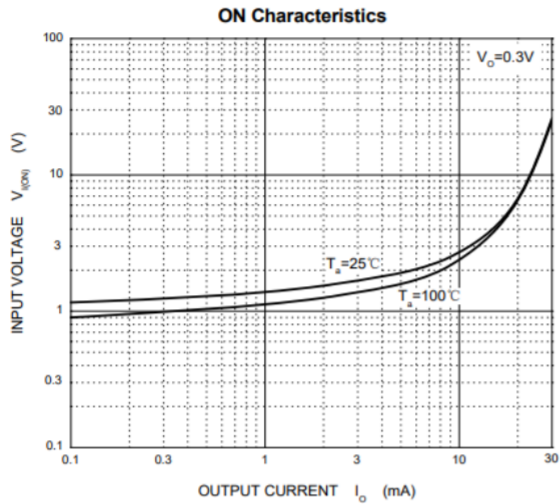

Typical Characteristics

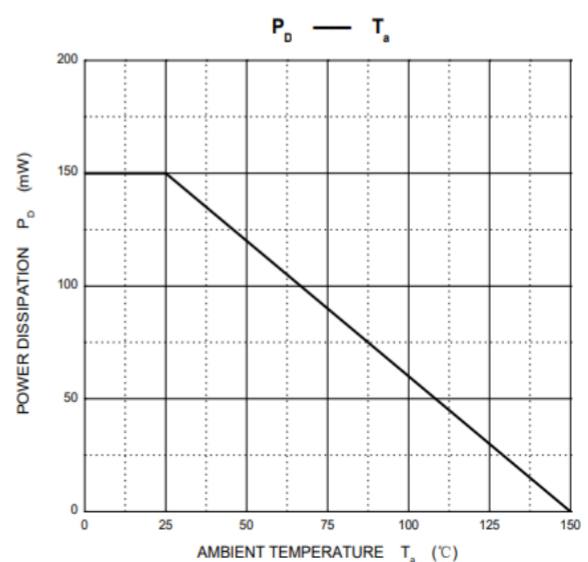
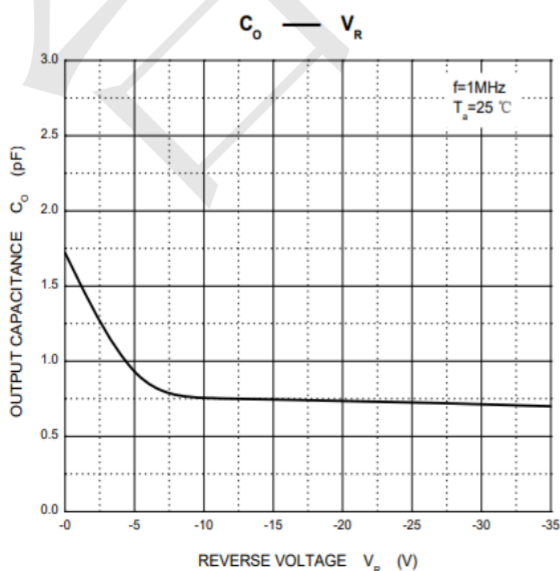
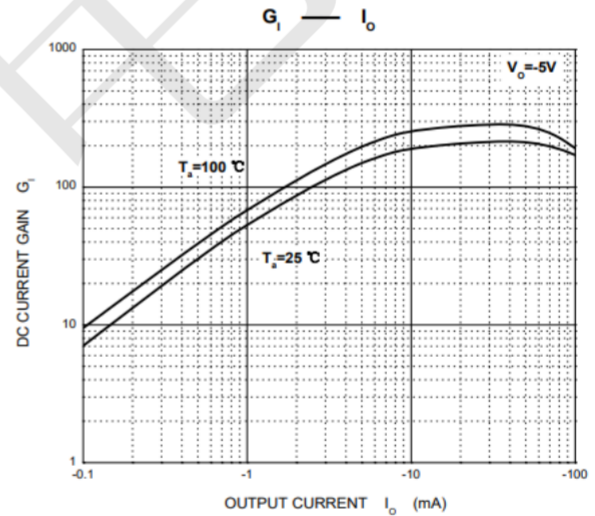
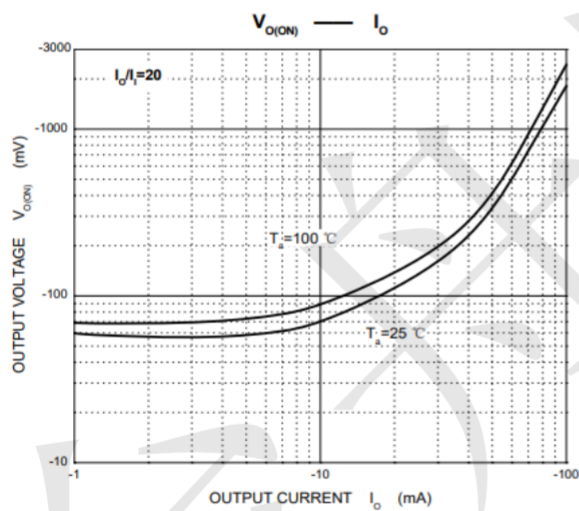
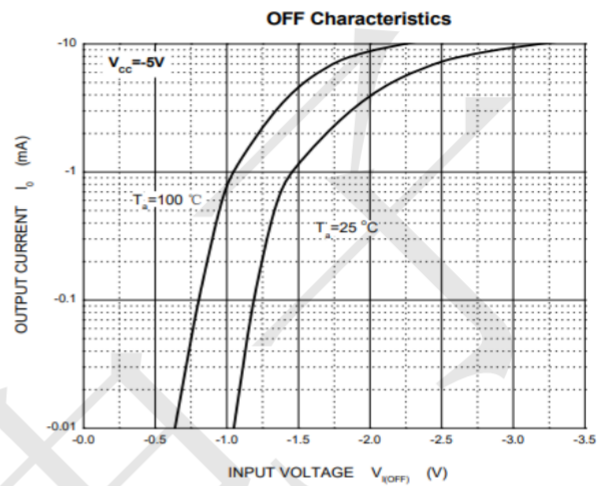
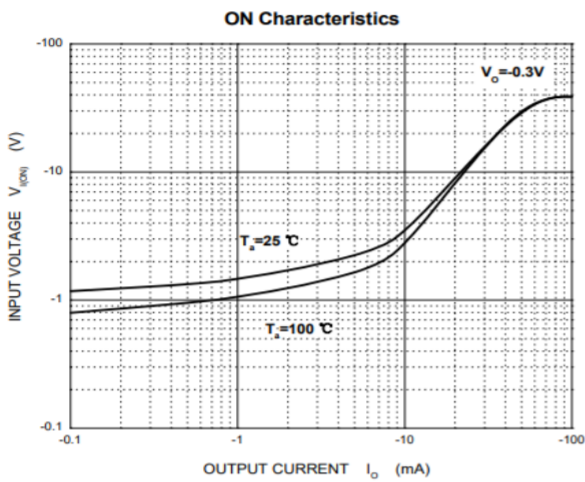

Package information (Unit: mm)

SOT-363

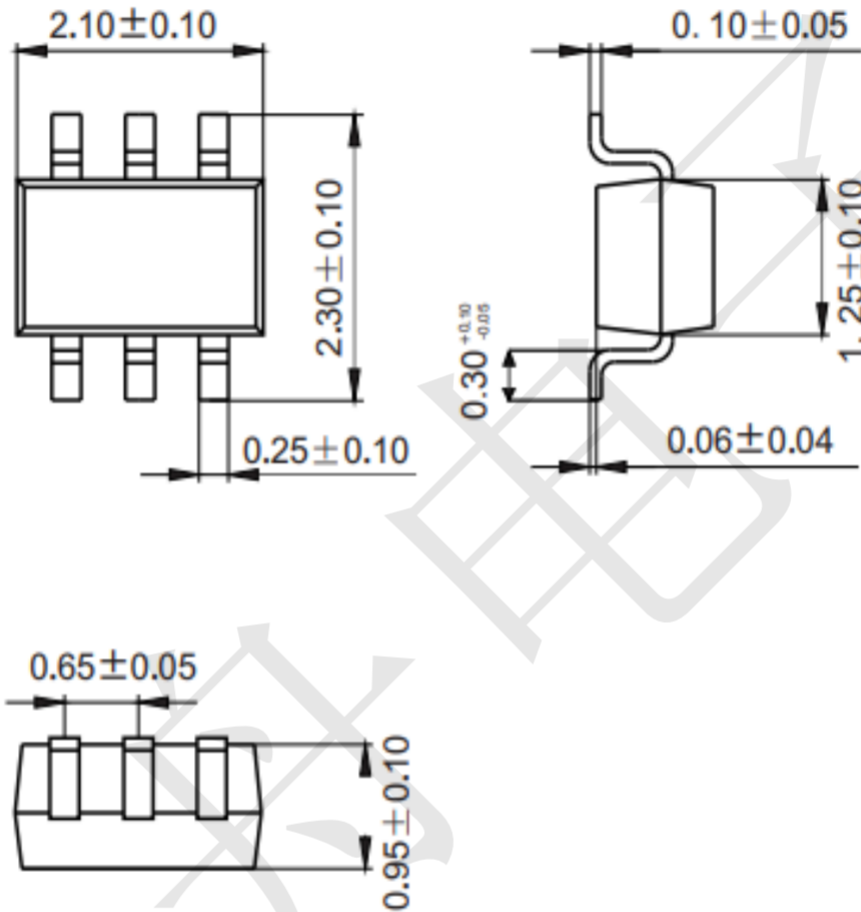

Mounting Pad Layout (Unit: mm)

