

Features

- ◆ 150W peak pulse power(8/20 μ s)
- ◆ Ultra low leakage: nA level
- ◆ Operating voltage: 24V
- ◆ Low clamping voltage
- ◆ Complies with following standards:
 - IEC 61000-4-2 (ESD) immunity test
 - Air discharge: \pm 30kV
 - Contact discharge: \pm 30kV
 - IEC61000-4-4 (EFT) 40A (5/50ns)
 - IEC61000-4-5 (Lightning) 4A (8/20 μ s)
- ◆ RoHS Compliant

Mechanical Characteristics

- ◆ Package: SOT-23
- ◆ Lead Finish: Matte Tin
- ◆ Case Material: "Green" Molding Compound.
- ◆ UL Flammability Classification Rating 94V-0
- ◆ Moisture Sensitivity: Level 3 per J STD 020
- ◆ Shipping Qty : 3000pcs/7Inch Tape & Reel

Applications

- ◆ Cellular Handsets and Accessories
- ◆ Notebooks and Handhelds
- ◆ Portable Instrumentation
- ◆ Set Top Box
- ◆ Industrial Controls
- ◆ CAN Bus Protection
- ◆ Automotive Appllcatrons

Dimensions and Pin Configuration

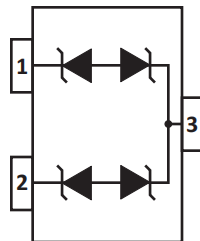

TPESD2IVN24T-QR

2-Line bi-directional TVS Diode

WWW.TECHPUBLIC.COM

Absolute Maximum Ratings (Tamb=25°C unless otherwise specified)

Parameter	Symbol	Value	Unit
Peak Pulse Power (8/20μs)	Ppk	140	W
Peak Pulse Current (8/20μs)	IPP	4	A
ESD per IEC 61000-4-2 (Air)	VESD	± 30	kV
ESD per IEC 61000-4-2 (Contact)		± 30	
Operating Temperature Range	TJ	-55 to +125	°C
Storage Temperature Range	Tstg	-55 to +150	°C

Electrical Characteristics (TA=25°C unless otherwise specified)

Parameter	Symbol	Min	Typ	Max	Unit	Test Condition
Reverse Working Voltage	VRWM			24	V	
Breakdown Voltage	VBR	26.7			V	IT = 1mA
Reverse Leakage Current	IR			0.08	μA	VRWM = 24V
Forward Voltage	VF		0.8	1.2	V	IF = 10mA
Clamping Voltage	VC		32		V	IPP = 1A (8 x 20μs pulse)
Clamping Voltage	VC		35	40	V	IPP = 4A (8 x 20μs pulse)
Junction Capacitance	CJ		10	18	pF	VR=0, f=1MHz, Pin 3to Pin 2, Or Pin 3 to Pin 2
Junction Capacitance	CJ		7		pF	VR=0, f=1MHz, Pin 1 to Pin 2 , Pin 1to Pin 2, Or Pin 2 to Pin1

Typical Performance Characteristics ($T_A=25^\circ\text{C}$ unless otherwise Specified)

Fig1. 8/20 μs Pulse Waveform

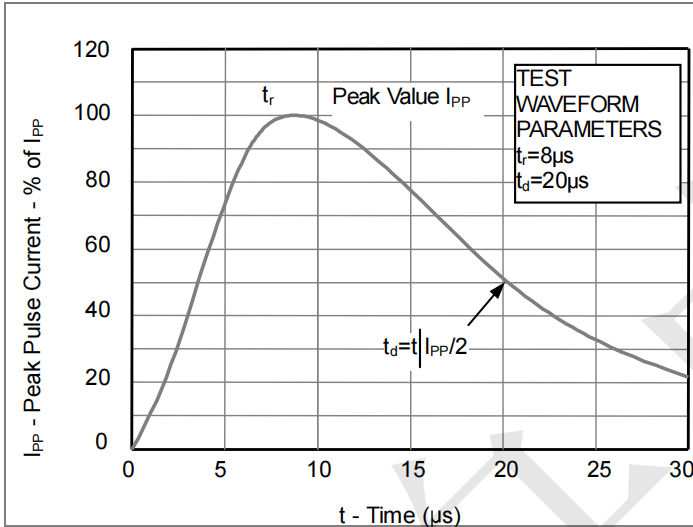

Fig2. ESD Pulse Waveform (according to IEC 61000-4-2)

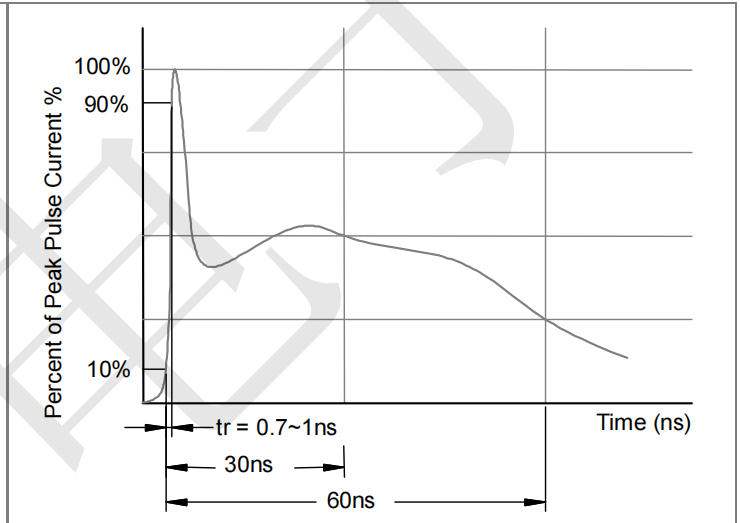
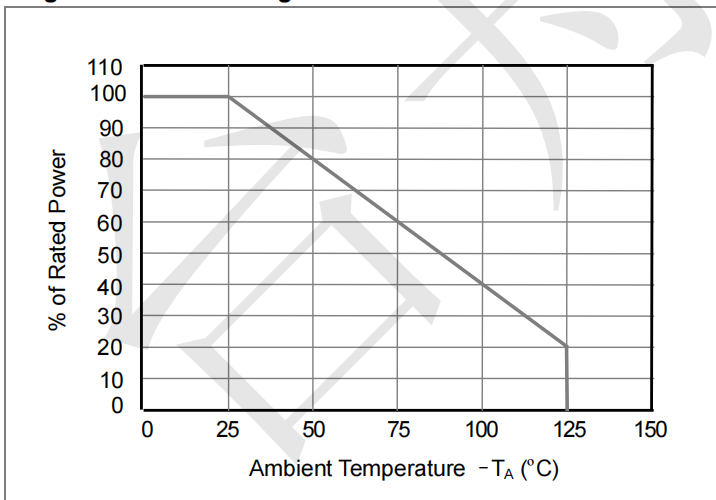
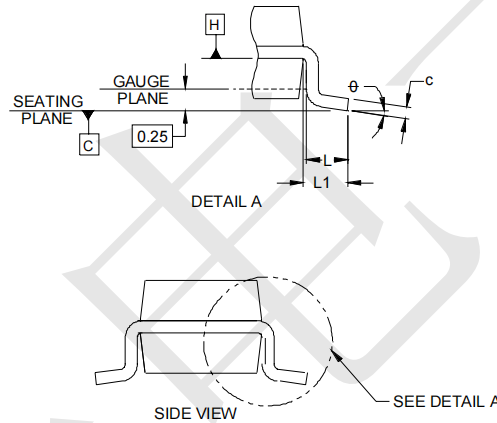
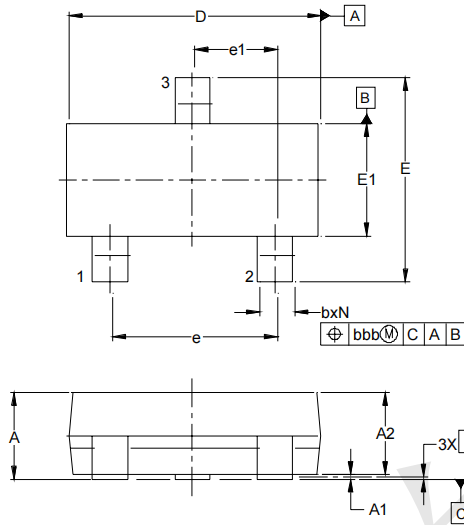

Fig3. Power Derating Curve



Outline Drawing - SOT23



DIM	INCHES			MILLIMETERS		
	MIN	NOM	MAX	MIN	NOM	MAX
A	.035	-	.044	0.89	-	1.12
A1	.000	-	.004	0.01	-	0.10
A2	.035	.037	.040	0.88	0.95	1.02
b	.012	-	.020	0.30	-	0.51
c	.003	-	.007	0.08	-	0.18
D	.110	.114	.120	2.80	2.90	3.04
E	.082	.093	.104	2.10	2.37	2.64
E1	.047	.051	.055	1.20	1.30	1.40
e	.075			1.90 BSC		
e1	.037			0.95 BSC		
L	.015	.020	.024	0.40	0.50	0.60
L1	.022			(0.55)		
N	3			3		
θ	0°	-	8°	0°	-	8°
aaa	.004			0.10		
bbb	.008			0.20		

Land Pattern - SOT23

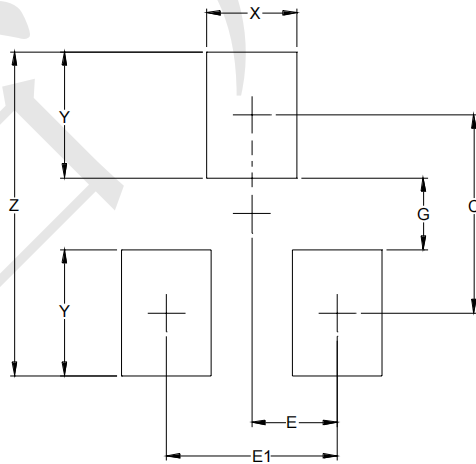

DIM	DIMENSIONS	
	INCHES	MILLIMETERS
C	(.087)	(2.20)
E	.037	0.95
E1	.075	1.90
G	.031	0.80
X	.039	1.00
Y	.055	1.40
Z	.141	3.60