

新品 变更



产品规格书

SPECIFICATION FOR APPROVAL

产品名称 Product Name:	石英晶体谐振器 Quartz crystal unit
产品型号 Product Type:	SMD3225
标称频率 Nominal Freq:	25.000000 MHz
明德亨料号 MDH P/N:	2.3.3.250001849
客户料号 Customer P/N:	

客户承认
Approved By Customer

签章
Signature:

日期
Date:

Date: 2024年2月21日

批准 Accepted	审核 Checked	拟制 Issued
顾至亮	刘德成	温传奇

烟台明德亨电子科技有限公司
YanTai MDH Technology Co.,Ltd
ADD.: 中国山东烟台开发区黑龙江路6号
No.6 Heilongjiang Road Yantai Development Zone,
Shandong, China

TEL: 86-535-6372640 FAX: 86-535-6394876

E-Mail: dynamic@public.ytppt.sd.cn

四川明德亨电子科技有限公司
SiChuan MDH Technology Co.,Ltd
ADD.: 中国四川泸州纳溪区东兴路6号
No.6 Dongxing Road Naxi Zone, Luzhou,
Sichuan,China

TEL: 86-830-2800890

<http://www.mingdeheng.com>

MSL:Level 1

RoHS Compliant

CONTENT

NO.	ITEM	PAGE
1	石英晶体产品规格及特性 Product specification and features	4
2	石英晶体外观尺寸 Product outline dimension	5
3	石英晶体内部结构及印字 Product internal structure and marking	6
4	石英晶体之可靠性 Product reliability	7-9
5	生产商及产地说明 Manufacturer and origin	10

2.0 外形尺寸、外观 / Outline dimensions、Appearances

2.1 产品外形尺寸(mm) / Product outline dimension(mm)

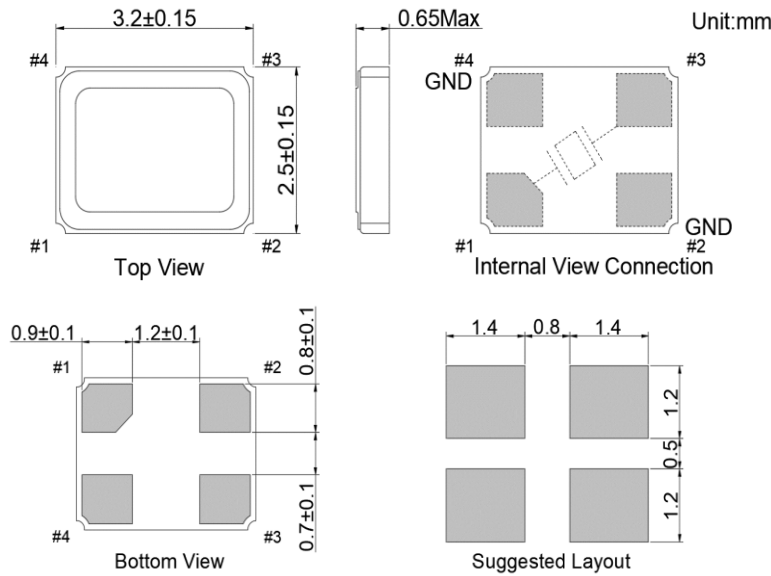

2.2 载带外形尺寸图 (mm) /Carrier Dimensional Drawing (mm)

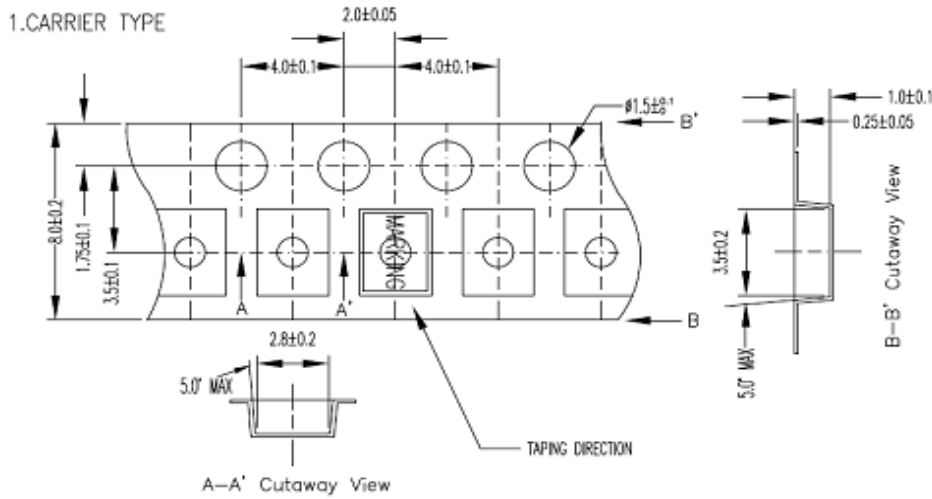

2.3 编带盘外形尺寸图(mm) /Reel Dimensional Drawing (mm)

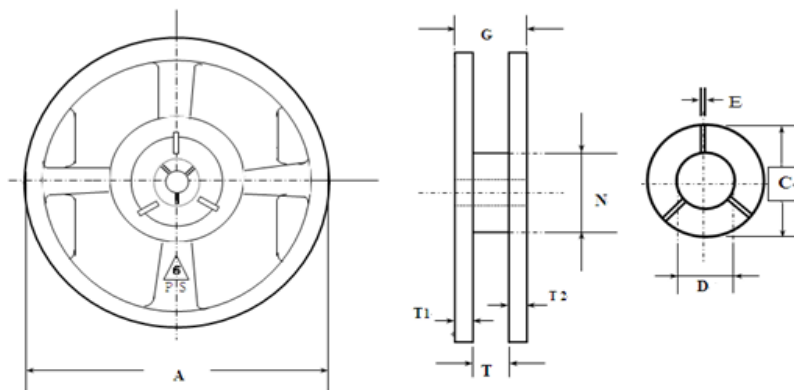

☆图示尺寸及公差 (mm) :

部位	A	T	T1, T2	N	C	D	E	G
尺寸	178	9.0	1.4	60.2	20.2	13.2	2.5	11.5
公差	±2.0	±0.5	±0.2	±0.5	±1.0	±0.5	±0.5	±1.4

2.4 印字 / Marking

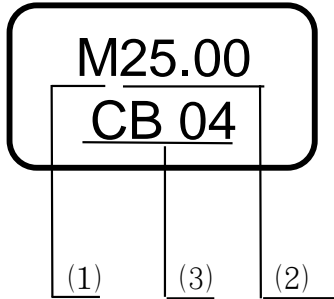

- (1) 代表公司Logo Company Logo
- (2) 代表标称频率 Nominal Freq
- (3) 代表批次号 Batch number

3.0 内部构造图 / Product internal structure

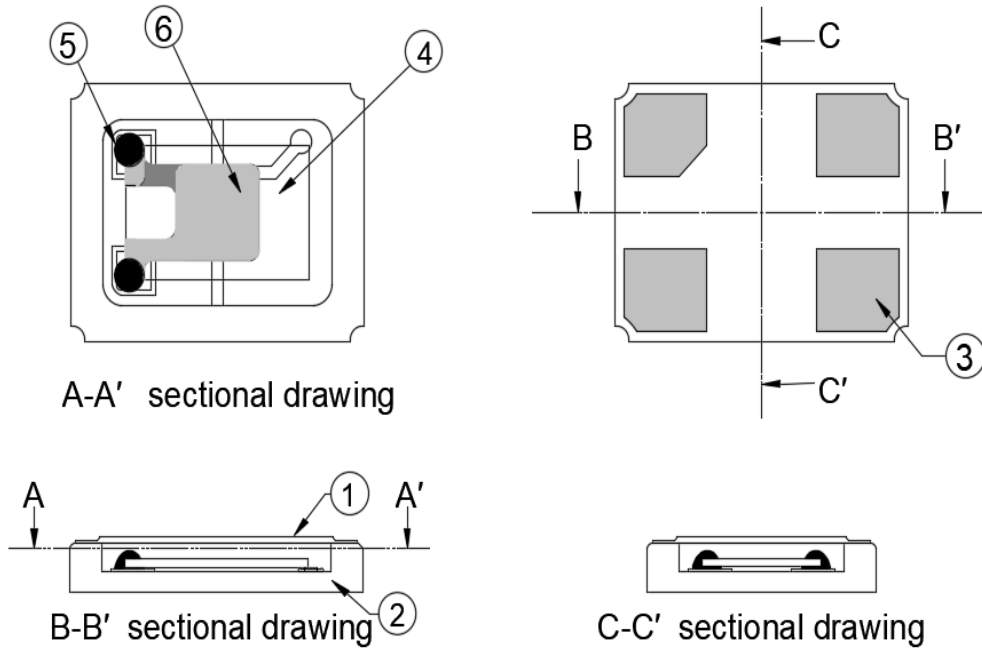

Unit Weight: 0.014±0.002g/pcs			
NO.	COMPONENETS	MATERIALS	SPECIFICATIONS
1	LID	Kovar (Fe/Co/Ni)	-
2	Package	Ceramic (Al ₂ O ₃) + Au/Ni	Ni plating + Au plating
3	Pad	Au/Ni/W	Tungsten metalize + Ni plating + Au plating
4	Crystal blank	SiO ₂	-
5	Conductive adhesive	Resin+Ag	Silicon resin
6	Electrode	Ag	-

4.0 石英晶体之可靠性 / Product reliability

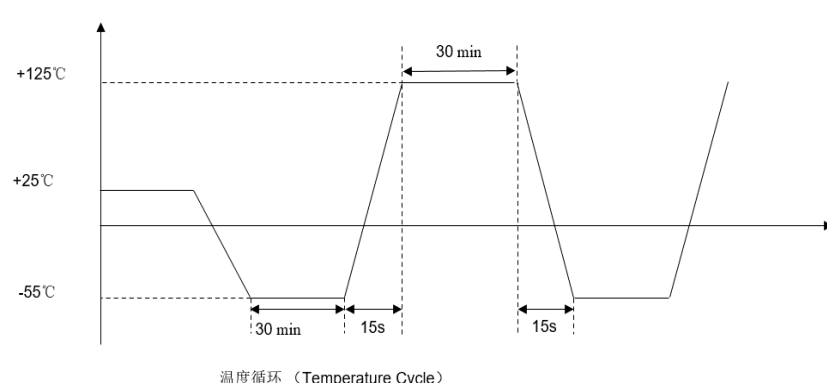
项目 (Item)	条件 (Condition)	结果 (Result)
A.1	耐低温性 (耐寒性) 测试 (Cold resistance)	(I)
	Stored at $-55\pm 2^{\circ}\text{C}$ for 500 ± 2 hrs then $25\pm 2^{\circ}\text{C}$ 2 hrs before testing	
A.2	耐高温性 (耐热性) 测试 (Heat resistance)	(I)
	Stored at $125\pm 2^{\circ}\text{C}$ for 500 ± 2 hrs then $25\pm 2^{\circ}\text{C}$ 2 hrs before testing	
A.3	耐湿热性 (Humidity Resistance Result)	(I)
	稳态温度: $85\pm 2^{\circ}\text{C}$; 湿度: $85\pm 3\% \text{RH}$; 时间: 500 ± 2 hrs Steady temperature: $85\pm 2^{\circ}\text{C}$; humidity: $85\pm 3\% \text{RH}$; time: 500 ± 2 hrs	
A.4	老化测试 (Aging)	(I)
	Stored at $85\pm 2^{\circ}\text{C}$ for 720 ± 2 Hrs then $25\pm 2^{\circ}\text{C}$ 2 Hrs before testing Stored at $25\pm 2^{\circ}\text{C}$ for 1 year	
A.5	气密性 (Leakage)	(IV)
	细漏 Fine leak: Put the product in the Helium pressure tank, 4 ~ 5kgf/cm^2 , 0.5hrs.	
A.6	冷热冲击实验 温度循环 (Temperature Cycle)	(I)
	<p>$-55^{\circ}\text{C} \sim 125^{\circ}\text{C}$, Retain 30Min, 100 cycles</p>  <p>温度循环 (Temperature Cycle)</p>	

4.1 机械性能 / Mechanism characteristics

B.1	跌落测试 (Drop Test) Device are dropped from a height of 150 cm onto 2cm thickness stainless plate executing 3 times of random drops.	(II)
B.2	耐振性 (Resistance of Vibration) Frequency: 10~55Hz, amplitude(total excursion): 1.5mm±15%,3 direction (X,Y,Z) each 2 hrs then 25±2°C 2 hrs before testing	(I)
B.3	可焊性试验 (Solderability) 245±5°C, 5±1s	(III)
B.4	耐焊接热 (Reflow) Resistance to soldering heat (Reflow) 参考曲线图 (Reference Curve) :	(II)
<p>TEMP. (°C)</p> <p>300</p> <p>250</p> <p>200</p> <p>180</p> <p>100</p> <p>50</p> <p>90-120s</p> <p>10-30s</p> <p>260 ± 5° C</p> <p>230 ± 5° C</p> <p>180 ± 10° C</p> <p>≥40s</p> <p>TIME (sec)</p>		

项目 Item	结果编号 Result NO.	规格要求 Specification Requirements
1	(I)	频率变化 $<\pm 10\text{ppm}$; 电阻变化 $<\pm 5\Omega$ 或规格电阻的15%, 取大者 Frequency variation $<\pm 10\text{ppm}$; Resistance variation $<\pm 5\Omega$ or $\pm 15\%$ of RR spec., select the bigger value.
2	(II)	频率变化 $<\pm 5\text{ppm}$; 电阻变化 $<\pm 5\Omega$ 或规格电阻的15%, 取大者 Frequency variation $<\pm 5\text{ppm}$; Resistance variation $<\pm 5\Omega$ or $\pm 15\%$ of RR spec., select the bigger value.
3	(III)	上锡覆盖率高于95% The covering rate of Tin-plating is more than 95%.
4	(IV)	$<1 \times 10^{-9}\text{Pa}\cdot\text{m}^3/\text{s}$ Max

5.0 生产商及产地说明 / Manufacturer and origin

生产商/Manufacturer: 烟台明德亨电子科技有限公司

YanTai MDH Technology Co.,Ltd

四川明德亨电子科技有限公司

SiChuan MDH Technology Co.,Ltd

5.1 包装规格 / Package specification

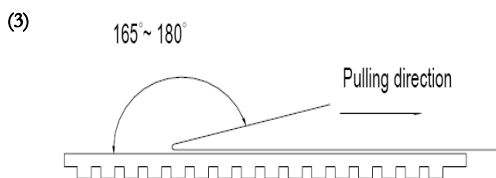
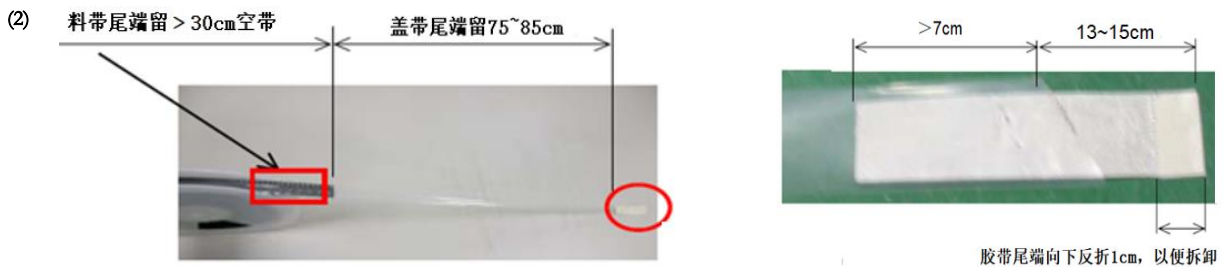
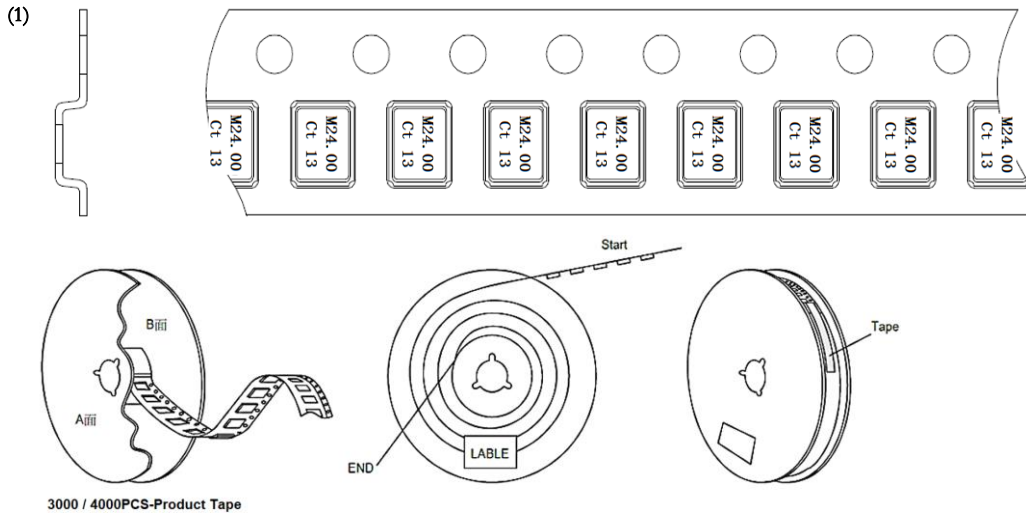

[STORAGE]

1. 未开封状态下的贮存期限为交货后12个月, 请在期限内使用。如果日期已超, 请在使用前对其电气特性再次确认。
The storage period in unopened condition is 12 months after delivery, please use within the period. If the date is over, double-check its electrical characteristics before use.

2. 本产品为电子元件, 请勿在结露状态下储存和使用。
This product is electronic component. Please do not store and use it in Dewy State.

3. 贮存环境温度为5℃~35℃, 相对湿度为30%~75%, 无阳光照射。
The storage environment shall be 5℃~35℃ temperature and 30%~75%RH humidity and free from the sun shine.