

750V, 156A, N-channel SiC power MOSFET
General Description:

NCES075P013D7 is a SiC MOSFET that contributes to miniaturization and low power consumption of applications. This product achieves industry-leading low on-resistance without sacrificing short-circuit withstand time. This is a TO263-7L package type with a driver source terminal that can maximize the high-speed switching performance that is a feature of SiC MOSFETs.

Features

- Low on-resistance
- Fast switching speed
- Fast reverse recovery
- Easy to parallel
- Simple to drive
- Pb-free lead plating ; RoHS compliant

Application

- Solar inverters
- DC/DC converters
- Switch mode power supplies
- Induction heating
- Motor drives

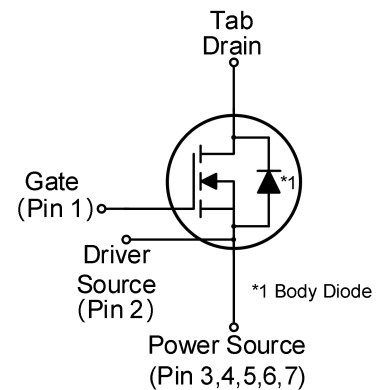
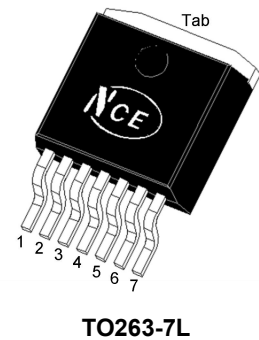
Schematic diagram

Package Marking and Ordering Information

Device	Device Package	Device Marking
NCES075P013D7	TO263-7L	NCES075P013D7

Absolute Maximum Ratings (T_c=25°C unless otherwise noted)

Parameter	Symbol	Limit	Unit
Drain-Source Voltage	V _{DS}	750	V
Gate-Source Voltage,max static voltage	V _{GS}	-10 to +24	V
Gate-Source Voltage,max transient voltage (Note 1)	V _{GS}	-11 to +26	V
Drain Current-Continuous (Note 2)	I _D	156	A
Drain Current-Continuous(T _C =100°C)	I _D (100°C)	110	A
Pulsed Drain Current (Note 3)	I _{DM}	390	A
Maximum Power Dissipation	P _D	T _{vj} = 25°C	500
		T _{vj} = 100°C	250
Recommended turn-on gate - source drive voltage	V _{GS_on}	+15 to +18	V
Recommended turn-off gate - source drive voltage	V _{GS_off}	-4 to 0	V
Virtual junction temperature	T _{vj}	175	°C
Operating Junction and Storage Temperature Range	T _J , T _{STG}	-55 To 175	°C

Thermal Characteristic

Symbol	Parameter	Value	Units
R _{θJC}	Thermal Resistance, Junction to case	0.3	°C/W

Electrical Characteristics (T_c=25°C unless otherwise noted)

Parameter	Symbol	Condition	Min	Typ	Max	Unit	
Off Characteristics							
Drain-Source Breakdown Voltage	BV _{DSS}	V _{GS} =0V, I _D =100μA	750			V	
Zero Gate Voltage Drain Current	I _{DSS}	V _{DS} =750V, V _{GS} =0V	T _{vj} = 25°C	1	80	μA	
			T _{vj} = 175°C	2			
Gate-Body Leakage Current	I _{GSS}	V _{GS} =-10V / +24V, V _{DS} =0V			±100	nA	
On Characteristics (Note 4)							
Gate Threshold Voltage	V _{GS(th)}	V _{DS} =V _{GS} , I _D =17mA	T _{vj} = 25°C	1.9	3.0	4.8	V
			T _{vj} = 175°C		2.1		
Drain-Source On-State Resistance	R _{DS(ON)}	V _{GS} =18V, I _D =60A	T _{vj} = 25°C	13	17	mΩ	
			T _{vj} = 175°C	15			
Drain-Source On-State Resistance	R _{DS(ON)}	V _{GS} =15V, I _D =60A	T _{vj} = 25°C	18	24	mΩ	
			T _{vj} = 175°C	21			
Gate input resistance	R _G	f=1MHZ, open drain		0.5		Ω	
Forward Transconductance	g _{FS}	V _{DS} =20V, I _D =60A		14		S	
Dynamic Characteristics (Note 5)							
Input Capacitance	C _{ISS}	V _{DS} =500V, V _{GS} =0V, f=1MHZ		4980		pF	
Output Capacitance	C _{OSS}			445		pF	
Reverse Transfer Capacitance	C _{RSS}			15.5		pF	
C _{OSS} stored energy	E _{OSS}			61.5		μJ	
Output charge	Q _{OSS}	Calculated by C _{OSS} (f)V _{DS} @1MHZ		340		nC	
Effective output capacitance, energy related	C _{O(er)}	V _{DS} =0-500V, V _{GS} =0V		493		pF	
Effective output capacitance, time related	C _{O(tr)}	I _C =constant, V _{DS} =0-500V, V _{GS} =0V		680		pF	
Switching Characteristics (Note 5)							
Turn-on Delay Time	t _{d(on)}	V _{DD} =500V, I _D =60A, V _{GS} =+18V / -3V, R _G =2.7Ω, L=200μH		20.8		ns	
Turn-on Rise Time	t _r			31.2		ns	
Turn-Off Delay Time	t _{d(off)}			41.4		ns	
Turn-Off Fall Time	t _f			10.8		ns	
Turn-on energy	E _{on}	V _{DD} =500V, I _D =60A, V _{GS} =+18V / -3V, R _G =2.7Ω, L=200μH	T _{vj} = 25°C	317		μJ	
			T _{vj} = 175°C	276		μJ	
Turn-off energy	E _{off}	R _G =2.7Ω, L=200μH	T _{vj} = 25°C	206		μJ	
			T _{vj} = 175°C	263		μJ	
Total Gate Charge	Q _g	V _{DS} =500V, I _D =60A, V _{GS} =-3/18V		186		nC	
Gate-Source Charge	Q _{gs}			54		nC	
Gate-Drain Charge	Q _{gd}			57		nC	

Electrical Characteristics (T_C=25°C unless otherwise noted)

Parameter	Symbol	Condition	Min	Typ	Max	Unit
Drain-Source Diode Characteristics						
Diode Forward Voltage (Note 4)	V _{SD}	V _{GS} =0V, I _{SD} =60A	T _{vj} = 25°C		3.4	V
			T _{vj} = 175°C		3.0	
Reverse Recovery Time	t _{rr}	T _J = 25°C, I _F =60A, V _R =500V, di/dt = 3930A/μs (Note3)		22.4		ns
Reverse Recovery Charge	Q _{rr}			597		nC
Peak reverse recovery current	I _{rrm}			46.5		A

Notes:

1. t_p < 500ns, D < 0.01
2. Repetitive Rating: Pulse width limited by maximum junction temperature.
3. PW ≤ 10μs, Duty cycle ≤ 1%
4. Pulse Test: Pulse Width ≤ 300μs, Duty Cycle ≤ 2%.
5. Guaranteed by design, not subject to production

Test Circuit

Fig.1-1 Gate Charge Measurement Circuit

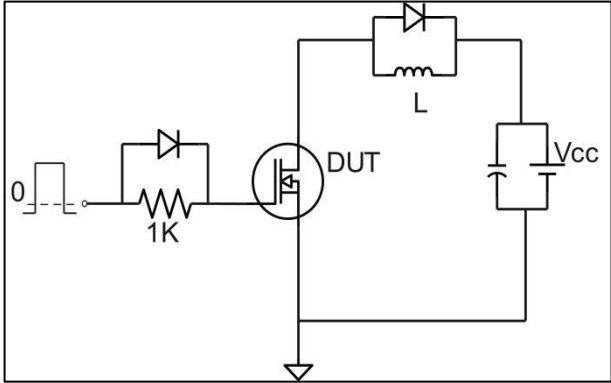

Fig.1-2 Gate Charge Waveform

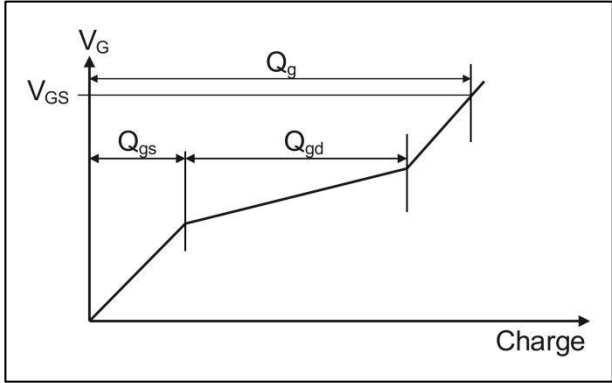

Fig.2-1 Switching Characteristics Measurement Circuit

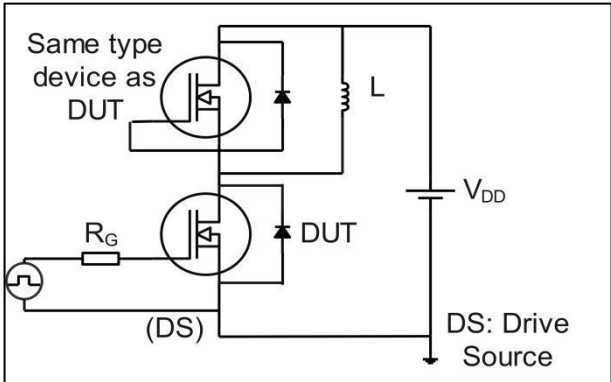
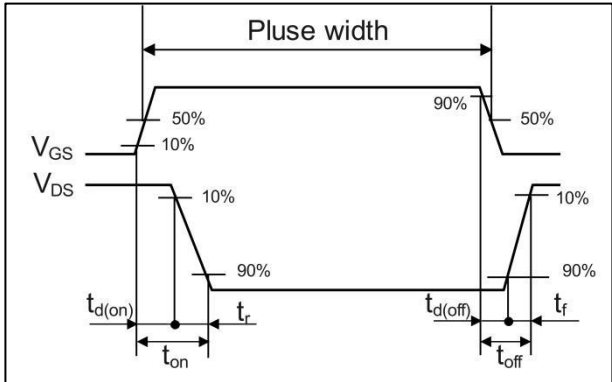

Fig.2-2 Waveforms for Switching Time



Typical Electrical and Thermal Characteristics

Fig.1 Power Dissipation Derating Curve

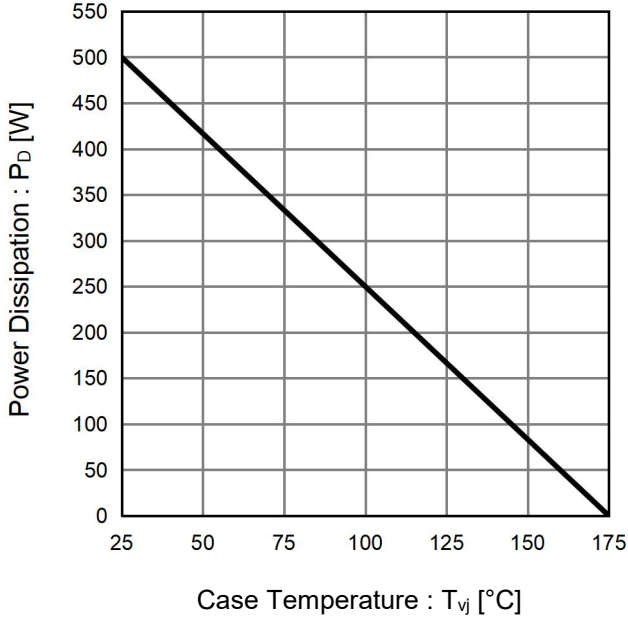

Fig.2 Maximum Safe Operating Area

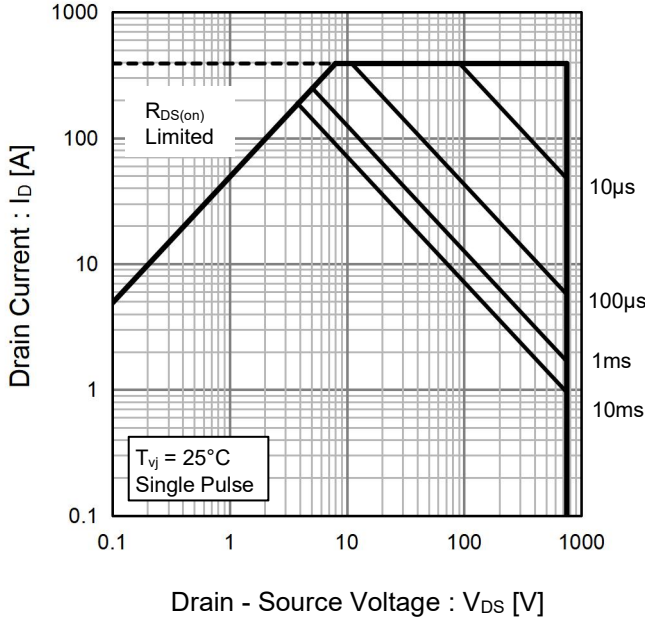

Fig.3 Typical Transient Thermal Impedance vs. Pulse Width

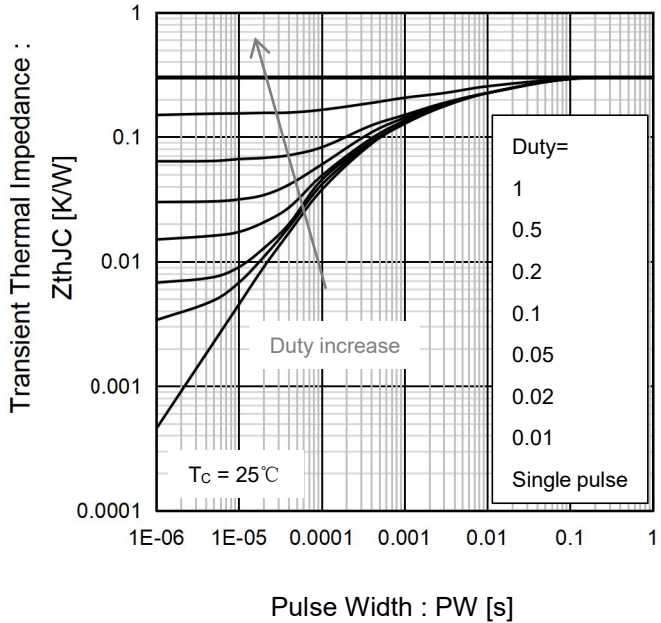

Fig.4 $T_{vj} = 25^{\circ}\text{C}$ Typical Output Characteristics

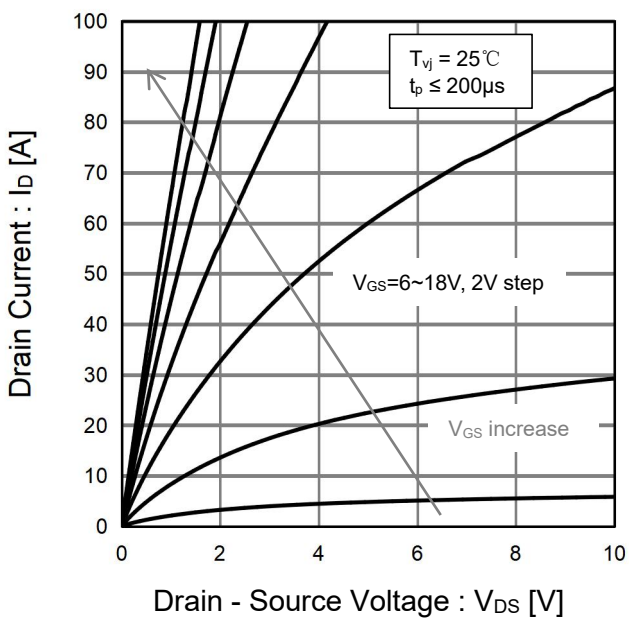

Fig.5 $T_{vj} = 25^{\circ}\text{C}$ 3rd Quadrant Characteristics

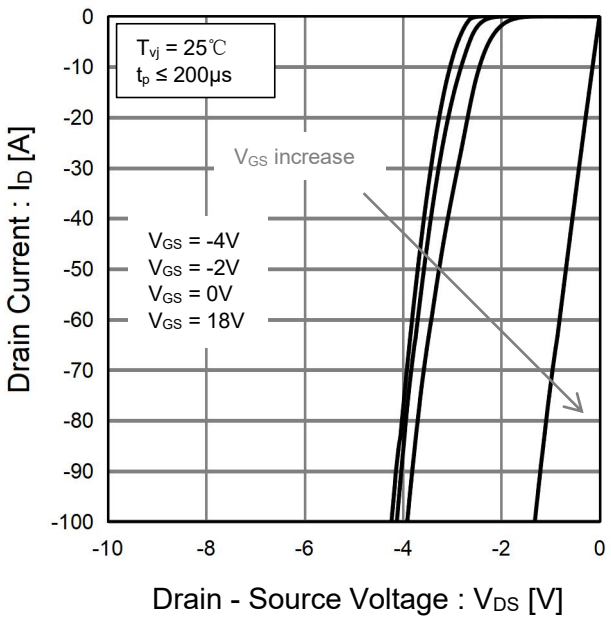

Fig.6 $T_{vj} = 175^{\circ}\text{C}$ Typical Output Characteristics

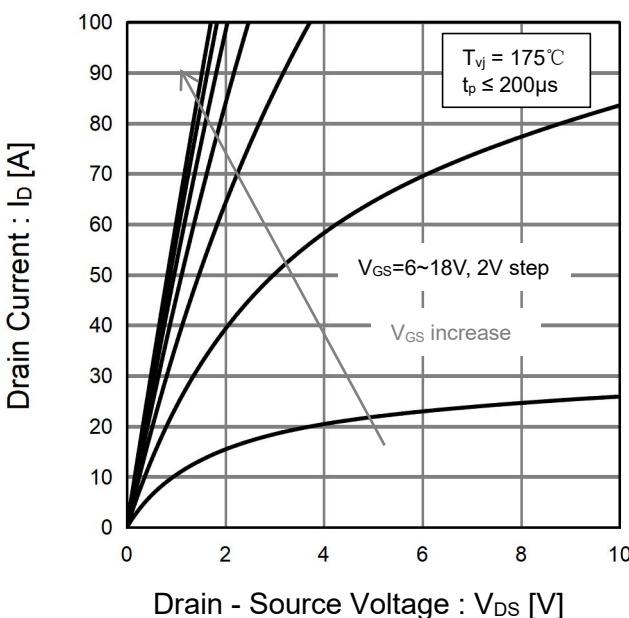

Fig.7 $T_{vj} = 175^{\circ}\text{C}$ 3rd Quadrant Characteristics

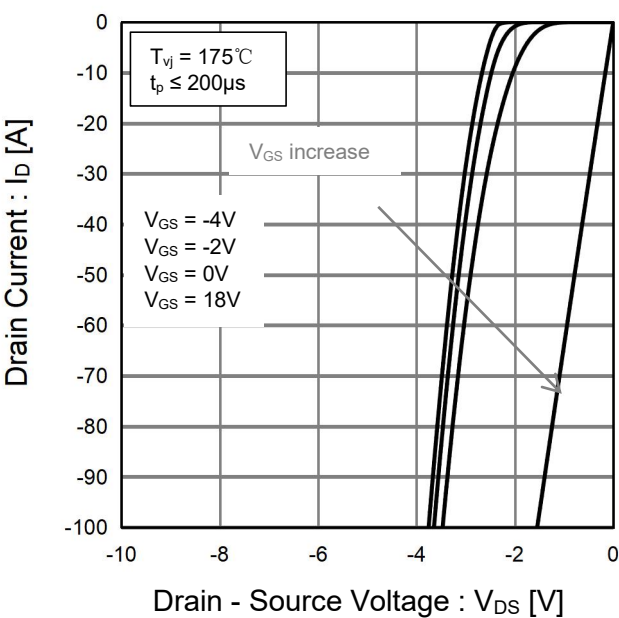

Fig.8 Typical Transfer Characteristics

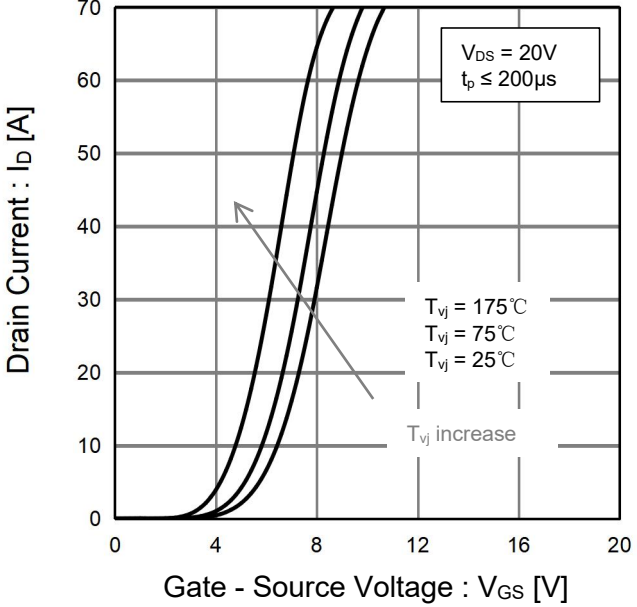

Fig.9 Static Drain - Source On - State Resistance vs. Gate - Source Voltage

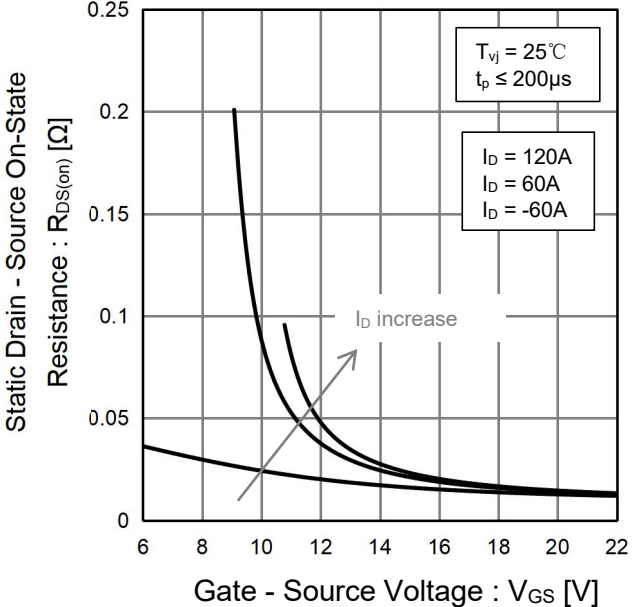

Fig.10 Static Drain - Source On - State Resistance vs. Drain Current

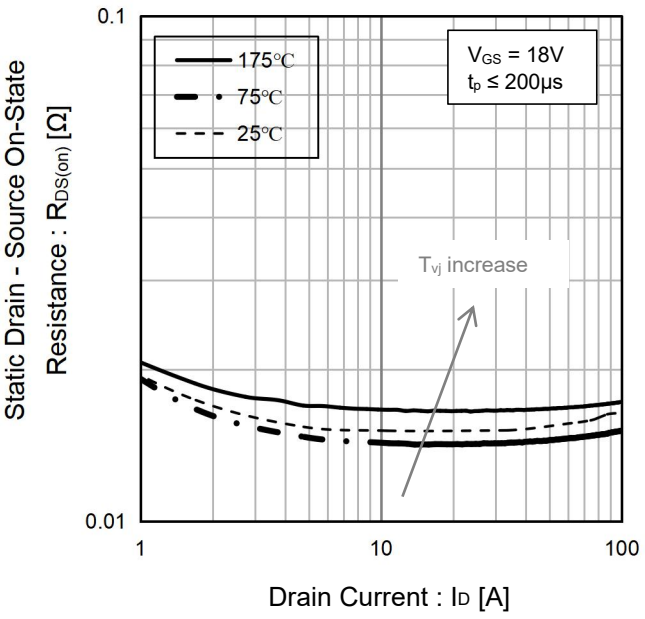

Fig.11 Static Drain - Source On - State Resistance vs. Virtual Junction Temperature

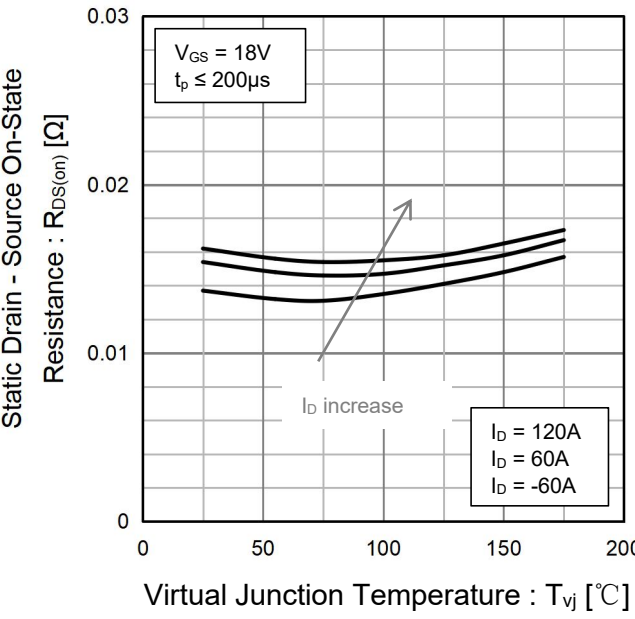

Fig.12 Body Diode Forward Voltage vs. Gate - Source Voltage

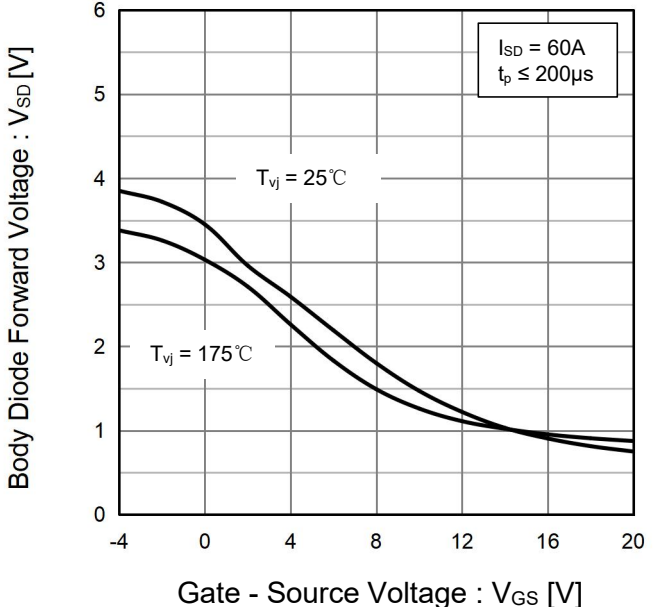

Fig.13 Gate Threshold Voltage vs. Virtual Junction Temperature

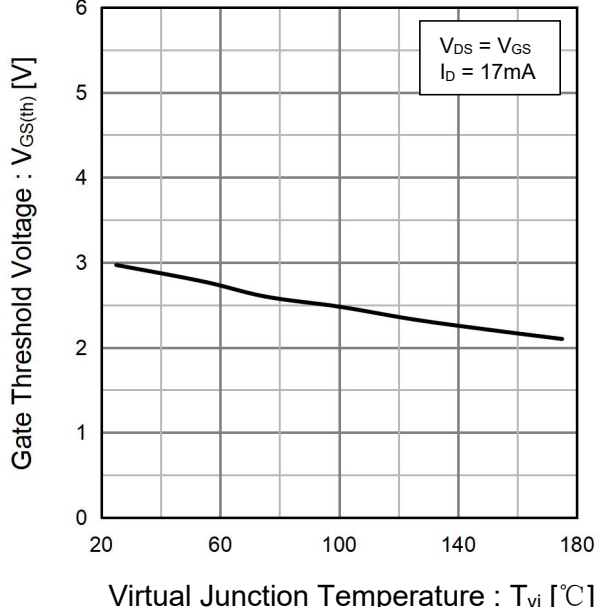

Fig.14 Typical Capacitance vs. Drain - Source Voltage

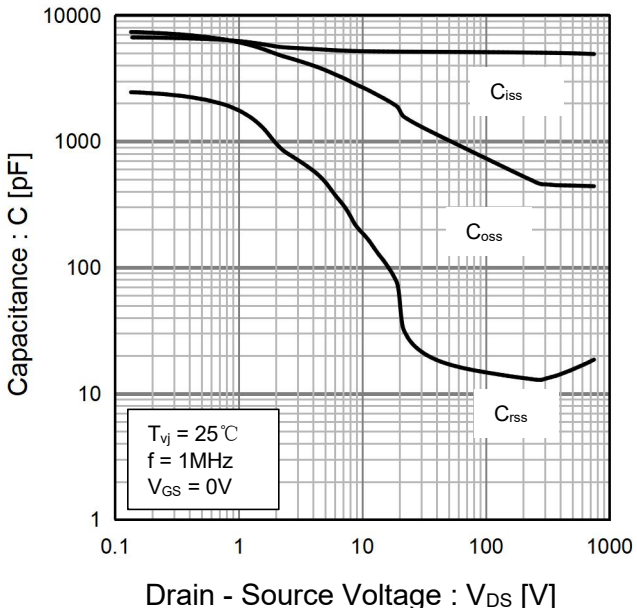

Fig.15 Coss Stored Energy

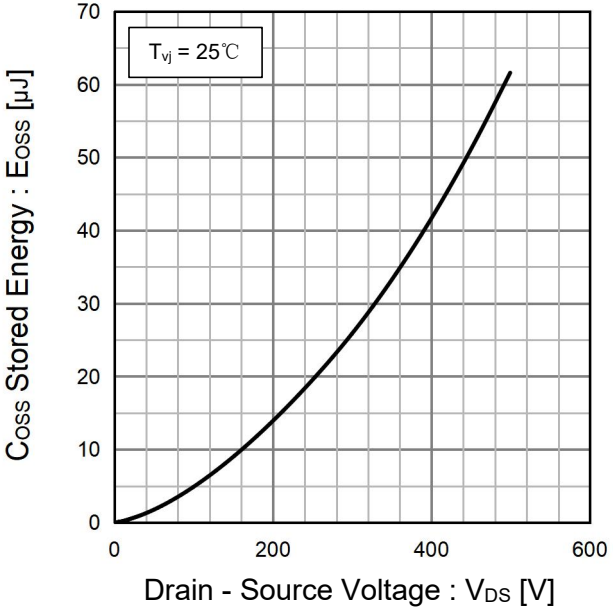

Fig.16 Dynamic Input Characteristics

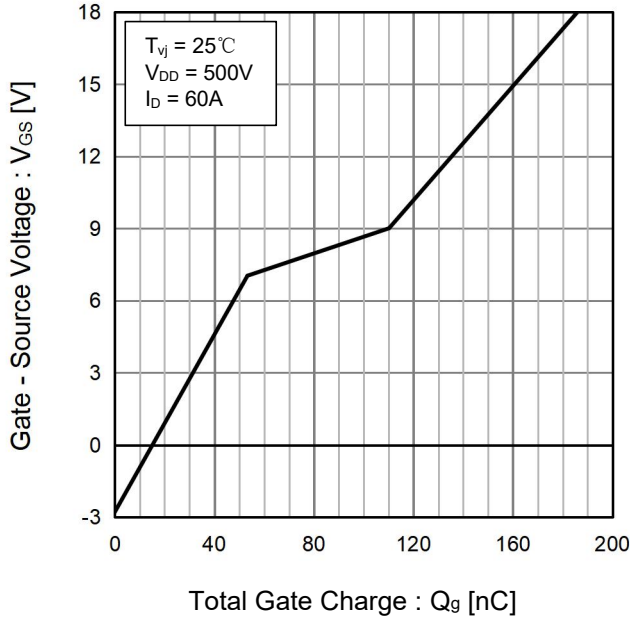

Fig.17 Typical Switching Time vs. External Gate Resistance

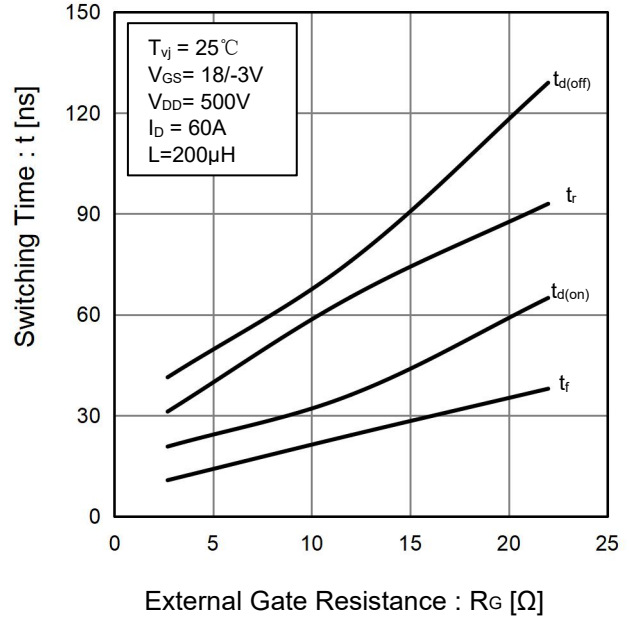

Fig.18 Typical Switching Energy vs. External Gate Resistance

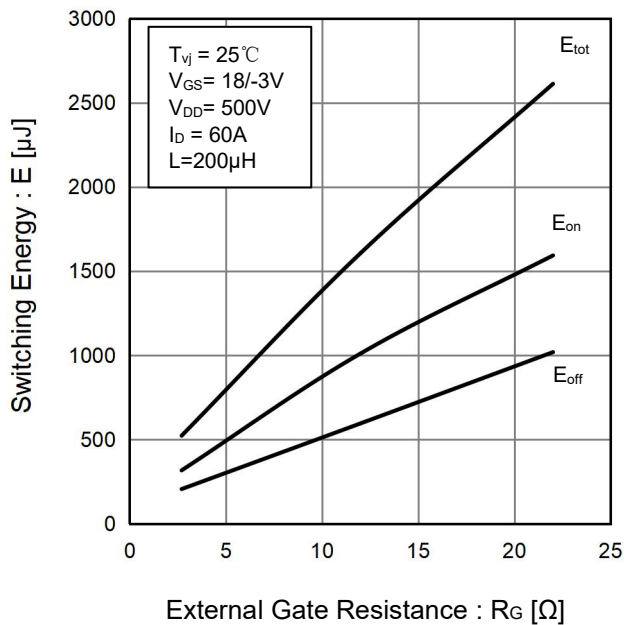

Fig.19 Typical Switching Energy vs. Drain Current

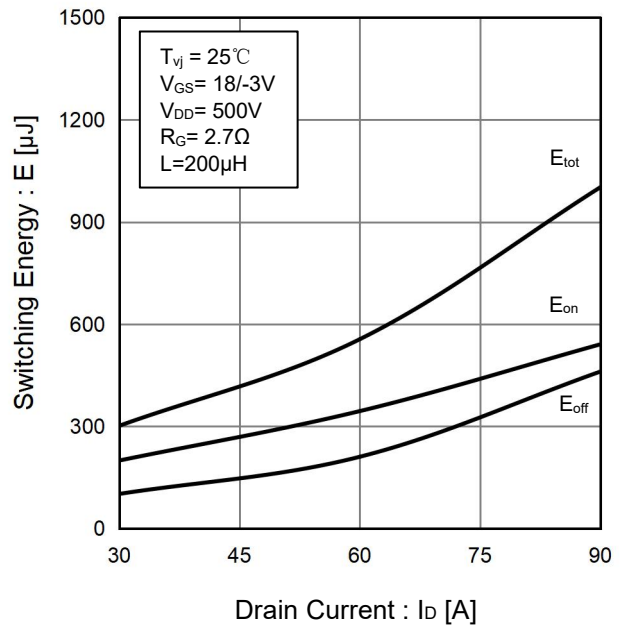
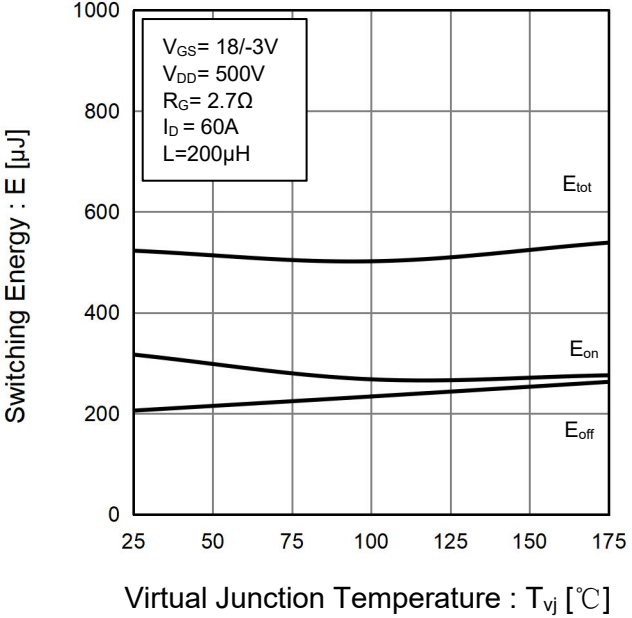
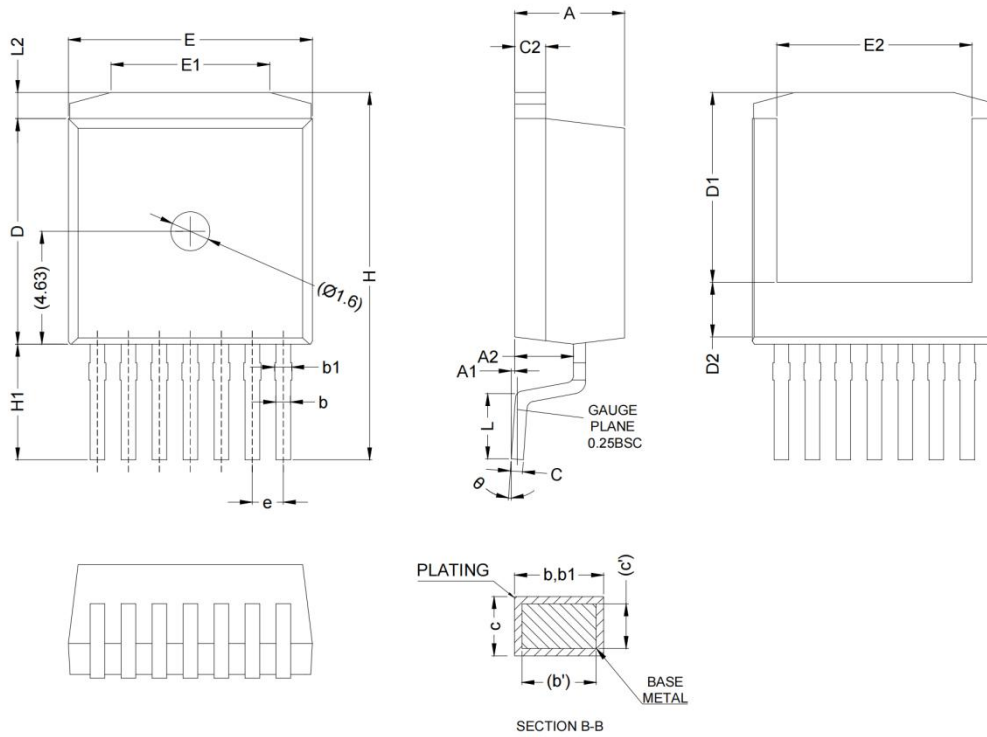

Fig.20 Typical Switching Energy vs. Virtual Junction Temperature



TO263-7L Package Information



Items	Min	Max
A	4.30	4.70
A1	-	0.25
A2	2.20	2.60
b	0.52	0.72
b'	0.50	0.70
b1	0.60	0.80
c	0.42	0.62
c'	0.40	0.60
c2	1.07	1.47
D	9.05	9.45
D1	7.58	7.98
D2	2.05	2.45
e	1.27 BSC	
E	9.80	10.20
E1	6.30	6.70
E2	7.80	8.20
L	2.48	2.88
L2	0.87	1.27
H	14.87	15.27
H1	4.55	4.95
θ	0°	8°

Attention:

- Any and all NCE power products described or contained herein do not have specifications that can handle applications that require extremely high levels of reliability, such as life-support systems, aircraft's control systems, or other applications whose failure can be reasonably expected to result in serious physical and/or material damage. Consult with your NCE power representative nearest you before using any NCE power products described or contained herein in such applications.
- NCE power assumes no responsibility for equipment failures that result from using products at values that exceed, even momentarily, rated values (such as maximum ratings, operating condition ranges, or other parameters) listed in products specifications of any and all NCE power products described or contained herein.
- Specifications of any and all NCE power products described or contained herein stipulate the performance, characteristics, and functions of the described products in the independent state, and are not guarantees of the performance, characteristics, and functions of the described products as mounted in the customer's products or equipment. To verify symptoms and states that cannot be evaluated in an independent device, the customer should always evaluate and test devices mounted in the customer's products or equipment.
- NCE power Semiconductor CO.,LTD. strives to supply high-quality high-reliability products. However, any and all semiconductor products fail with some probability. It is possible that these probabilistic failures could give rise to accidents or events that could endanger human lives, that could give rise to smoke or fire, or that could cause damage to other property. When designing equipment, adopt safety measures so that these kinds of accidents or events cannot occur. Such measures include but are not limited to protective circuits and error prevention circuits for safe design, redundant design, and structural design.
- In the event that any or all NCE power products(including technical data, services) described or contained herein are controlled under any of applicable local export control laws and regulations, such products must not be exported without obtaining the export license from the authorities concerned in accordance with the above law.
- No part of this publication may be reproduced or transmitted in any form or by any means, electronic or mechanical, including photocopying and recording, or any information storage or retrieval system, or otherwise, without the prior written permission of NCE power Semiconductor CO.,LTD.
- Information (including circuit diagrams and circuit parameters) herein is for example only ; it is not guaranteed for volume production. NCE power believes information herein is accurate and reliable, but no guarantees are made or implied regarding its use or any infringements of intellectual property rights or other rights of third parties.
- Any and all information described or contained herein are subject to change without notice due to product/technology improvement, etc. When designing equipment, refer to the "Delivery Specification" for the NCE power product that you intend to use.
- This catalog provides information as of Sep.2010. Specifications and information herein are subject to change without notice.