

SUNWAY MLCC DATASHEET



MH0603A106M6R3N8RN

Size : 0603

TC Char. : X5R

Capacitance: 10 μ F (\pm 20%)

Rated Voltage: 6.3 V

RoHS compliant & Halogen free



CATALOGUE

1. ORDERING INFORMATION	2
2. STRUCTURE AND DIMENSION	3
3. THICKNESS CLASSES AND QUANTITY	3
4. TESTS AND REQUIREMENTS	3
5. SOLDERING	9
6. PRECAUTION	9
7. PACKING	23
8. SUNWAY CONTACT	24

1. ORDERING INFORMATION

1.1 SCOPE

This specification describes 0603-X5R-106-6.3V chip capacitor with lead-free terminations.

1.2 FEATURES

- Supplied in paper on reel
- Nickel-barrier end termination
- RoHS compliant
- Halogen Free compliant

1.3 ORDERING INFORMATION-GLOBAL PART NUMBER

All part numbers are identified by the series, size, tolerance, TC characteristic, capacitance, tolerance, rated voltage, control code, thickness, packing code, size tolerance.

1.4 GLOBAL PART NUMBER

MH	0603	A	106	M	6R3	N	8	R	N
(1)	(2)	(3)	(4)	(5)	(6)	(7)	(8)	(9)	(10)

SERIAL NUMBER	PROEKT	CODE	CODE MEANING
(1)	SERIES	MH	High capacitance(> =1 μ F)
(2)	SIZE	0603	L:0.06 inch W:0.03 inch
(3)	TEMPERATURE CHARACTERISTIC	A	X5R:-55~+85 $^{\circ}$ C Δ C/C: \pm 15%
(4)	CAPACITANCE	106	10 μ F
(5)	TOLERANCE	M	\pm 20%
(6)	RATED VOLTAGE	6R3	6.3 V
(7)	CONTROL CODE	N	Normal
(8)	THICKNESS	8	0.8mm
(9)	PACKING CODE	R	07" Paper tape
(10)	SIZE TOLERANCE	N	\pm 0.10mm

2. CONSTRUCTION AND DIMENSION

Table 1 For outlines see Fig. 2

P/N	Size(inch)	L1(mm)	W(mm)	T(mm)	L2/L3(mm)		L4(mm)
					min	Max	min
MH0603A106M6R3N8RN	0603	1.6 ± 0.1	0.8 ± 0.1	0.8 ± 0.1	0.2	0.6	0.4

OUTLINES

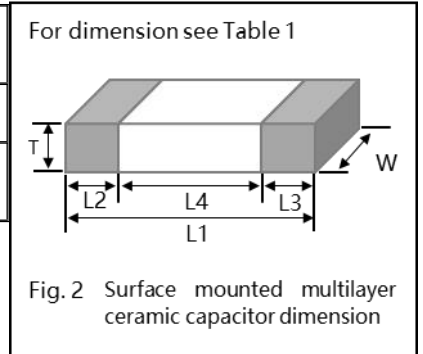

3. THICKNESS CLASSES AND QUANTITY

THICKNESS CLASSES AND QUANTITY

SIZE CODE	THICKNESS CLASSIFICATION	TAPE WIDTH QUANTITY PER REEL	Ø 180 MM / 7 INCH		Ø 330 MM / 13 INCH	
			Paper	Blister	Paper	Blister
0603	0.8±0.1 mm	8 mm	4,000	---	15,000	---

4. TESTS AND REQUIREMENTS

TESTS AND REQUIREMENTS

Test procedures and requirements

TEST	TEST METHOD	PROCEDURE	REQUIREMENTS
Mounting	IEC 60384-21/22	4.1 The capacitors may be mounted on printed-circuit boards or ceramic substrates	No visible damage
Visual Inspection and Dimension Check		4.2 Any applicable method using × 10 magnification	No defects or abnormalities.
Capacitance(1)		4.3.1 Class 2 Preconditioning: Perform a heat treatment at 150+0/-10°C for 1hour and then let sit for 24±2hours at room temperature, then measure.	Within specified tolerance
Dissipation Factor (D.F.)(1)		4.3.2 Measurement Temperature at 25°C Measurement Frequency : 1.0±0.1KHz Measurement Voltage : 1.0±0.2Vrms	D.F: ≤0.1
Insulation Resistance		4.4 Measurement Temperature at 25°C Measurement Voltage Rated Voltage At Ur (DC) for 1 minute Charge/discharge current 50mA max.	IR ≥ 10 GΩ Or IR × C ≥ 50s whichever is less

TESTS AND REQUIREMENTS

Test procedures and requirements

TEST	TEST METHOD	PROCEDURE	REQUIREMENTS												
Temperature Characteristic	IEC 60384-21/22 4.5	<p>Preconditioning:</p> <p>Perform a heat treatment at 150+0/-10°C for 1hour and then let sit for 24±2hours at room temperature, then measure.</p> <p>Capacitance shall be measured by the steps shown in the following table.</p> <p>The capacitance change should be measured after 5 min at each specified temperature stage</p> <table border="1" data-bbox="582 593 1129 891"> <thead> <tr> <th>Step</th> <th>Temperature(°C)</th> </tr> </thead> <tbody> <tr> <td>a</td> <td>25±2</td> </tr> <tr> <td>b</td> <td>Lower temperature±3°C</td> </tr> <tr> <td>c</td> <td>25±2</td> </tr> <tr> <td>d</td> <td>Upper temperature±3°C</td> </tr> <tr> <td>e</td> <td>25±2</td> </tr> </tbody> </table> <p>Class II</p> <p>Capacitance Change shall be calculated from the formula as below</p> $\Delta C = \frac{C2 - C1}{C1} \times 100\%$ <p>C1: Capacitance at step c C2: Capacitance at step b or d</p> <p>Measuring at voltage ≤1Vrms (Measurement Condition : Refer to the individual data sheet)</p>	Step	Temperature(°C)	a	25±2	b	Lower temperature±3°C	c	25±2	d	Upper temperature±3°C	e	25±2	Δ C/C: Within±15%
Step	Temperature(°C)														
a	25±2														
b	Lower temperature±3°C														
c	25±2														
d	Upper temperature±3°C														
e	25±2														
Adhesion	4.6	<p>Mounting method Solder the capacitor on the test substrate</p> <p>Applied Force : 5N</p> <p>Holding Time: 10±1s</p> <p>Applied Direction In parallel with the test substrate and vertical with the capacitor side</p>	<p>Criteria:</p> <p>No removal of the terminations and no visible damage upon appearance inspection.</p>												
Vibration	4.7	<p>Mounting method solder the capacitor on the test substrate.</p> <p>Kind of Vibration A simple harmonic motion 10Hz to 55Hz to 10Hz.</p> <p>Vibration Time: 1min.</p> <p>Total amplitude: 1.5mm.</p> <p>Vibration directions and time: This motion should be applied for a period of 2hours in each 3 mutually perpendicular directions (total of 6hours).</p>	<p>ΔC/C: Within±15%</p> <p>D.F.: Within the specified initial value.</p> <p>I.R: Within the specified initial value.</p>												

TESTS AND REQUIREMENTS

Test procedures and requirements

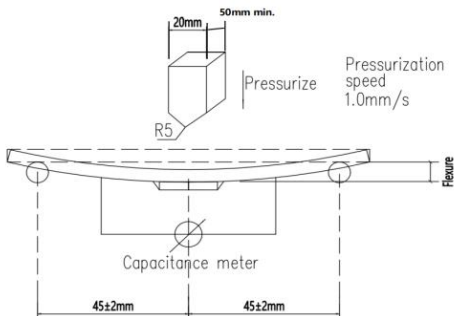
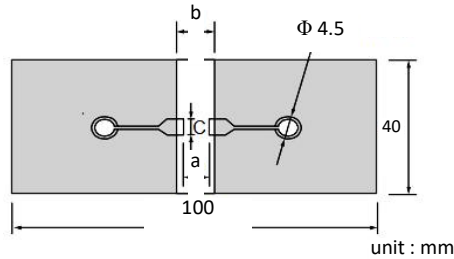
TEST	TEST METHOD	PROCEDURE	REQUIREMENTS									
Bond Strength	4.8	Mounting in accordance with IEC 60384-22 paragraph 8.9	No visible damage									
		<p>Conditions: bending 1 mm at a rate of 1 mm/s, radius jig 5 mm</p> <p>Keep the test board at the limit point in 5 sec. Then Measure Capacitance</p> <p>Pressurization Method:</p> 	<p>$\Delta C/C$: Within $\pm 10\%$</p> <table border="1" data-bbox="1157 515 1452 660"> <thead> <tr> <th rowspan="2">Type</th> <th colspan="3">Dimension(mm)</th> </tr> <tr> <th>a</th> <th>b</th> <th>c</th> </tr> </thead> <tbody> <tr> <td>0603</td> <td>1.0</td> <td>3.0</td> <td>1.2</td> </tr> </tbody> </table>	Type	Dimension(mm)			a	b	c	0603	1.0
Type	Dimension(mm)											
	a	b	c									
0603	1.0	3.0	1.2									
		Test Substrate:										
		 <p>unit : mm</p>										
Resistance to Soldering Heat	4.9	<p>Preconditioning:</p> <p>Perform a heat treatment at 150+0/-10°C for 1hour and then let sit for 24±2hours at room temperature, then measure.</p> <p>Preheating: for size ≤1206: 120°C to 150°C for 1 Minute</p> <p>Preheating: for size >1206: 100°C to 120°C for 1 minute and 170°C to 200°C for 1 minute</p> <p>Solder bath temperature: 270±5°C</p> <p>Dipping time: 10±0.5 seconds</p> <p>Recovery time: 24±2 hours</p>	<p>Dissolution of the end face plating shall not exceed 25% of the length of the edge concerned</p> <p>$\Delta C/C$: Within $\pm 15\%$</p> <p>D.F: within initial specified value</p> <p>IR: within initial specified value</p>									

TESTS AND REQUIREMENTS

Test procedures and requirements

TEST	TEST METHOD	PROCEDURE	REQUIREMENTS															
Solderability	IEC 60384-21/22	4.10 Preheated to a temperature of 80°C to 140°C and maintained for 30 seconds to 60 seconds. Temperature: 245±5°C / Dipping time: 3±0.5 s Depth of immersion: 10mm	The solder should cover over 95% of the critical area of each termination															
Rapid Change of Temperature	4.11	Preconditioning: Perform a heat treatment at 150+0/-10°C for 1hour and then let sit for 24±2hours at room temperature, then measure. 5 cycles with following detail: <table border="1"> <thead> <tr> <th>Step</th> <th>Temp(°C)</th> <th>Time</th> </tr> </thead> <tbody> <tr> <td>1</td> <td>Min Operating Temp: -55°C</td> <td>30±3min</td> </tr> <tr> <td>2</td> <td>Room Temp: 25°C</td> <td>2 ~3min</td> </tr> <tr> <td>3</td> <td>Max. Operating Temp: 85°C</td> <td>30±3min</td> </tr> <tr> <td>4</td> <td>Room Temp: 25°C</td> <td>2~ 3min</td> </tr> </tbody> </table> Recovery time after test: 24±2h	Step	Temp(°C)	Time	1	Min Operating Temp: -55°C	30±3min	2	Room Temp: 25°C	2 ~3min	3	Max. Operating Temp: 85°C	30±3min	4	Room Temp: 25°C	2~ 3min	No visual damage ΔC/C: Within±15% D.F. meet initial specified value IR meet initial specified value
Step	Temp(°C)	Time																
1	Min Operating Temp: -55°C	30±3min																
2	Room Temp: 25°C	2 ~3min																
3	Max. Operating Temp: 85°C	30±3min																
4	Room Temp: 25°C	2~ 3min																
Damp Heat with Ur Load	IEC 60384-21/22	4.12 1. Preconditioning: Perform a heat treatment at 150+0/-10°C for 1hour and then let sit for 24±2hours at room temperature, then measure. 2. Initial measure : spec: refer to initial spec C, D, IR 3. Damp heat test:500±12 hours at 40±2°C;90 to 95% R.H. 1.0 Ur applied 4. Recovery : Class 2: 24 ± 2 hours 5. Final measure: C, D, IR P.S. If the capacitance value is less than the minimum value permitted, then after the other measurements have been made the capacitor shall be preconditioned according to "IEC 60384 4.1" and then the requirement shall be met	No visual damage after recovery ΔC/C: Within±12.5% D.F.: ≤0.2 IR: 500 MΩ or IR x C ≥12. 5s whichever is less															

TESTS AND REQUIREMENTS

Test procedures and requirements

TEST	TEST METHOD	PROCEDURE	REQUIREMENTS
Endurance	IEC 60384-21/22 4.13	<ol style="list-style-type: none"> Preconditioning: Perform a heat treatment at $150+0/-10^{\circ}\text{C}$ for 1hour and then let sit for 24 ± 2hours at room temperature, then measure. Initial measure : spec: refer to initial spec C, D.F, IR Endurance test: <ul style="list-style-type: none"> Temperature: X5R:85°C Specified rated voltage applied for 1,000 hours. Applied $1.0 \times U_r$ for high cap. Products Recovery time: 24 ± 2 hours Final measure: C, D.F, IR <p>P.S. If the capacitance value is less than the minimum value permitted, then after the other measurements have been made the capacitor shall be preconditioned according to "IEC 60384 4.1" and then the requirement shall be met</p>	<p>No visual damage</p> <p>$\Delta C/C$: Within $\pm 12.5\%$</p> <p>D.F.: ≤ 0.2</p> <p>IR: $500 \text{ M}\Omega$ or $\text{IR} \times C \geq 25\text{s}$ whichever is less</p>
Voltage Proof	IEC 60384-1 4.14	<p>Specified stress voltage applied for 1~5 seconds</p> <p>$U_r \leq 100 \text{ V}$: series applied $2.5 U_r$</p> <p>$100 \text{ V} < U_r \leq 200 \text{ V}$ series applied $(1.5 U_r + 100)$</p> <p>$200 \text{ V} < U_r \leq 500 \text{ V}$ series applied $(1.3 U_r + 100)$</p> <p>$U_r > 500 \text{ V}$: $1.3 U_r$</p> <p>$U_r \geq 1000 \text{ V}$: $1.2 U_r$</p> <p>Charge/Discharge current is less than 50 mA</p>	No breakdown or flashover

5. SOLDERING

5.1 REFLOW SOLDERING

MLCC is in a direct contact with the dissolved solder during soldering, which may be exposed to potential mechanical stress caused by the sudden temperature change. Therefore, MLCC may be contaminated by the location movement and flux. For the reason, the mounting process must be closely monitored.

Method		Classification
Reflow soldering	Overall heating	Infrared rays
		Hot plate
		VPS(Vapor phase)
	Local heating	Air heater
		Laser
		Light beam

1. Reflow Profile

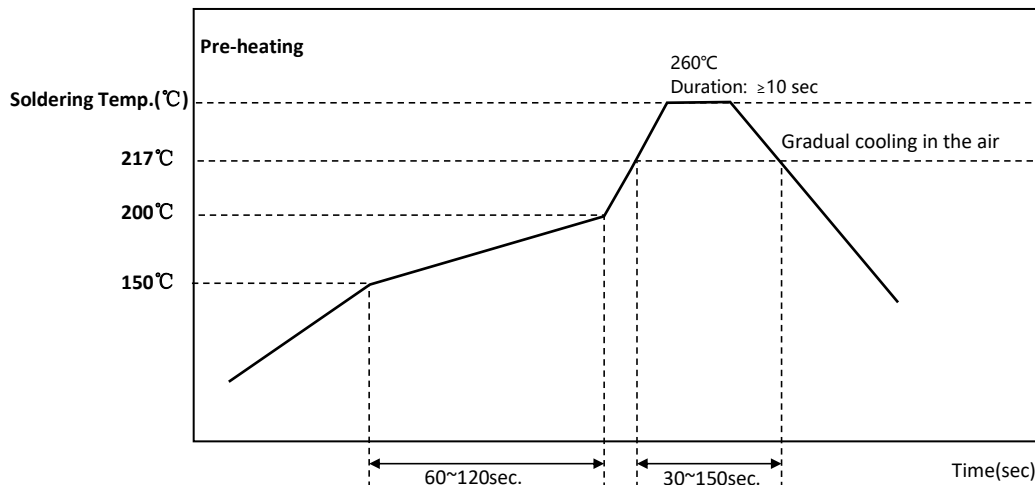

[Reflow Soldering Conditions]

Use caution not to exceed the peak temperature as shown. Pre-heating is necessary for all constituents including the PCB to prevent the mechanical damages on MLCC. The temperature difference between the PCB and the component surface must be kept to the minimum. As for reflow soldering, it is recommended to keep the number of reflow soldering to less than three times. Please check with us when the number of reflow soldering needs to exceed three times. Care must be exercised especially for the ultra-small size, thin film and high capacitance MLCC as they can be affected by thermal stress more easily.

2. Reflow temperature

The following quality problem may occur when MLCC is mounted with a lower temperature than the reflow temperature recommended by a solder manufacturer. The specified peak temperature must be maintained after taking into consideration the factors such as the placement of peripheral constituent and the reflow temperature.

- Drop in solder wettability
- Solder voids
- Potential occurrence of whisker
- Drop in adhesive strength
- Drop in self-alignment properties
- Potential occurrence of tombstones

3. Cooling

Natural cooling with air is recommended.

4. Optimum solder flux for reflow soldering

- Overly the thick application of solder pastes results in an excessive solder fillet height.
- This makes MLCC more vulnerable to the mechanical and thermal stress from the board, which may cause cracks in MLCC.
- Too little solder paste results in a lack of the adhesive strength, which may cause MLCC to isolate from PCB
- Check if solder has been applied uniformly after soldering is completed

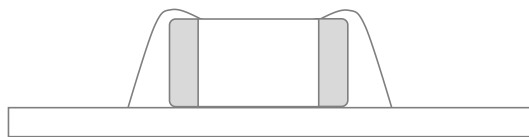

Too Much Solder
large stress may cause cracks

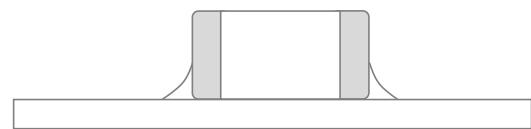

Not enough solder
Weak holding force may cause bad connections or detaching of the capacitor

- It is required to design a PCB with consideration of a solder land pattern and its size to apply an appropriate amount of solder to MLCC. The amount of the solder at the edge may impact directly on cracks in MLCC.
- The design of a suitable solder land is necessary since the more the solder amount is, the larger the force MLCC experiences and the higher the chance MLCC cracks.

5.2 FLOW SOLDERING

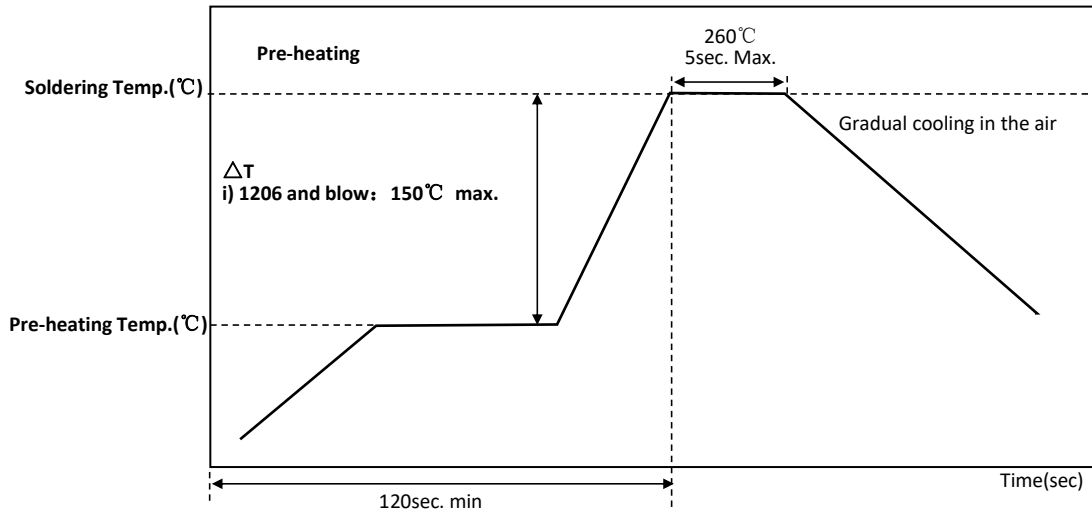

[Flow Soldering Conditions]

Take caution not to exceed peak temperature and time (5sec) as shown.

Please contact us before use the type of high capacitance and thin film MLCC for some exceptions that may be caused.

1. Caution before Flow soldering

- When a sudden heat is applied to MLCC, the mechanical rigidity of MLCC is deteriorated by the internal deformation of MLCC. Preheating all the constituents including PCB is required to prevent the mechanical damages on MLCC. The temperature difference between the solder and the surface of MLCC must be kept to the minimum.
- If the flow time is too long or the flow temperature is too high, the adhesive strength with PCB may be deteriorated by the leaching phenomenon of the outer termination, or the capacitance value may be dropped by weak adhesion between the internal termination and the outer termination.

5.3 SOLDERING IRON

Manual soldering can pose a great risk on creating thermal cracks in MLCC. The high temperature soldering iron tip may come into a direct contact with the ceramic body of MLCC due to the carelessness of an operator. Therefore, the soldering iron must be handled carefully, and close attention must be paid to the selection of the soldering iron tip and to temperature control of the tip.

2. How to use a soldering Iron

- In order to minimize damages on MLCC, preheating MLCC and PCB is necessary.
- A hot plate and a hot air type preheater should be used for preheating Do not cool down MLCC and PCB rapidly after soldering.
- Keep the contact time between the outer termination of MLCC and the soldering iron as short as possible. Long soldering time may cause problems such as adhesion deterioration by the leaching phenomenon of the outer termination.

Case size (inch)	Variation of Temp.	Soldering Temp.(°C)	Pre-heating Time(sec)	Soldering Time(sec)
0201~1206	$\Delta T \leq 190$	350°C max	≥ 60	≤ 3
1210~2220	$\Delta T \leq 130$	280°C max	≥ 60	≤ 3

※ Control ΔT in the solder iron and preheating temperature

Condition of Iron facilities

Wattage	Tip diameter	Soldering time
20W max	3mm max	3sec max

※ Caution - Iron tip should not contact with ceramic body directly
Lead-free solder: Sn-3.0Ag-0.5Cu

2. How to use a spot heater

Compared to local heating using a solder iron, heat by a spot heater heats the overall MLCC and the PCB, which is likely to lessen the thermal shocks.

For a high density PCB, a spot heater can prevent the problem to connect between a solder iron and MLCC directly.

- If the distance from the air nozzle outlet to MLCC is too close, MLCC may be cracked due to the thermal stress. Follow the conditions set in the table below to prevent this problem.
- The spot heater application angle as shown in the figure is recommended to create a suitable solder fillet shape.
- In case that heat of higher than 350°C is applied to MLCC containing epoxy material, the epoxy material in MLCC may be damaged by heat.

Distance	$\geq 5\text{mm}$
Hot Air Application angle	45°C
Hot Air Temperature Nozzle Outlet	$\leq 400^\circ\text{C}$
Application Time	$\leq 10\text{s}$

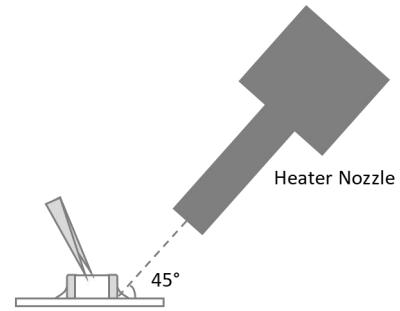

3. Cautions for re-work

- Too much solder amount will increase the risk of PCB bending or cause other damages.
- Too little solder amount will result in MLCC breaking loose from the PCB due to the inadequate adhesive strength.
- Check if the solder has been applied properly and ensure the solder fillet has a proper shape.

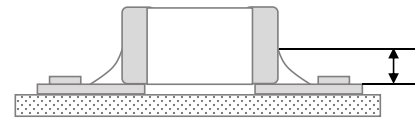

※ Soldering wire below $\varnothing 0.5\text{mm}$ is required for soldering

5.4 CLEANING

1. In general, cleaning is unnecessary if rosin flux is used.

When acidic flux is used strongly, chlorine in the flux may dissolve into some types of leaning fluids, thereby affecting the performance of MLCC. This means that the cleansing solution must be carefully selected and should always be new.

2. Cautions for cleaning

MLCC or solder joint may be cracked with the vibration of PCB, if ultrasonic vibration is too strong during cleaning. When high pressure cleaning equipment is used, test should be done for the cleaning equipment and its process before the cleaning in order to avoid damages on MLCC.

6. PRECAUTION

6.1 VIBRATION AND SHOCK

1. Please confirm the kind of vibration and/or shock, its condition, and any generation of resonance. Please mount the capacitor so as not to generate resonance, and do not allow any impact on the terminals.
2. Mechanical shock due to being dropped may cause damage or a crack in the dielectric material of the capacitor. Do not use a dropped capacitor because the quality and reliability may be deteriorated.
3. When printed circuit boards are piled up or handled, the corner of another printed circuit board should not be allowed to hit the capacitor, in order to avoid a crack or other damage to the capacitor.

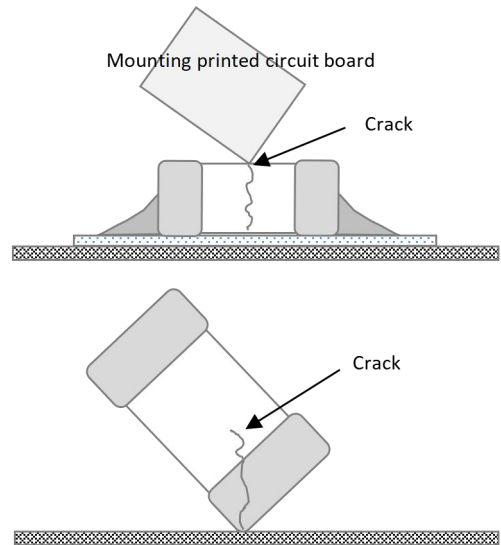

6.2 MOUNTING

Confirm the best mounting position and direction that minimizes the stress imposed on the capacitor during flexing or bending the printed circuit board

1. Mounting position

It is recommended to locate the major axis of MLCC in parallel to the direction in which the stress is applied.

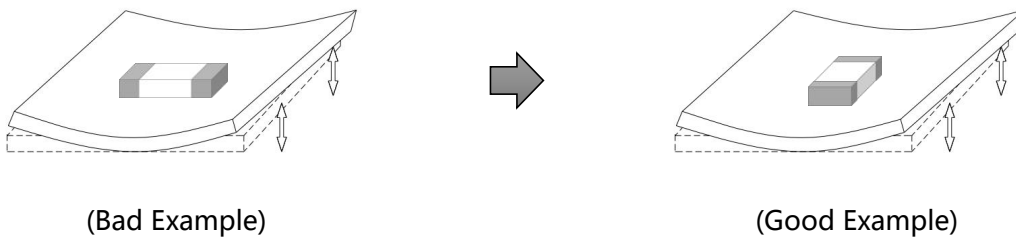

2. Cautions during mounting near the cutout

Please take the following measures to effectively reduce the stress generated from the cutting of PCB. Select the mounting location shown below, since the mechanical stress is affected by a location and a direction of MLCC mounted near the cutting line.

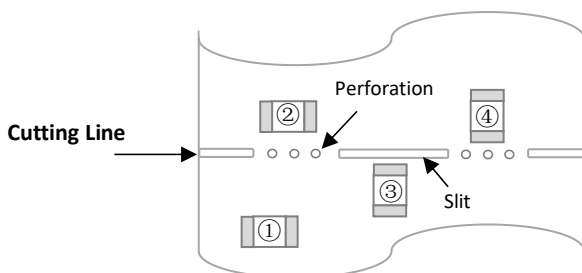

※ Relative mechanical stress

- ② > ①
- ③ > ①
- ④ > ①

3. Cautions during mounting near screw

If MLCC is mounted near a screw hole, the board deflection may be occurred by screw torque. Mount MLCC as far from the screw holes as possible

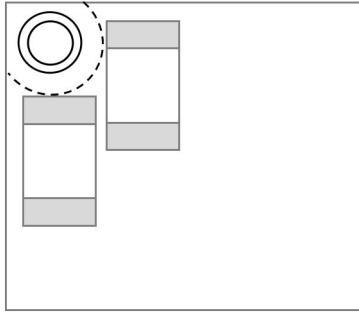

(Bad Example)

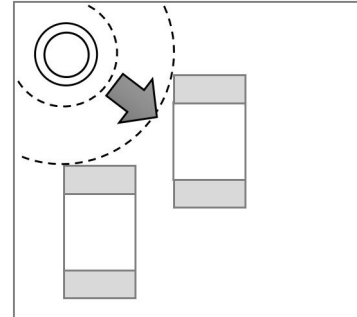

(Good Example)

6.3 CAUTION BEFORE MOUNTING

1. It is recommended to store and use MLCC in a reel. Do not re-use MLCC that was isolated from the reel.
2. Check the capacitance characteristics under actual applied voltage.
3. Check the mechanical stress when actual process and equipment is in use.
4. Check the rated capacitance, rated voltage and other electrical characteristics before assembly. Heat treatment must be done prior to measurement of capacitance.
5. Check the solderability of MLCC that has passed shelf life before use.
6. The use of Sn-Zn based solder may deteriorate the reliability of MLCC.

6.4 CAUTIONS DURING MOUNTING WITH MOUNTING(PICK-AND-PICK)MACHINES

1. Mounting Head Pressure

Excessive pressure may cause cracks in MLCC. It is recommended to adjust the nozzle pressure within the maximum value of 300g.f. Additional conditions must be set for both thin film and special purpose MLCC.

2. Bending Stress

When using a two-sided substrate, it is required to mount MLCC on one side first before mounting on the other side due to the bending of the substrate caused by the mounting head.

Support the substrate as shown in the picture below when MLCC is mounted on the other side.

If the substrate is not supported, bending of the substrate may cause cracks in MLCC.

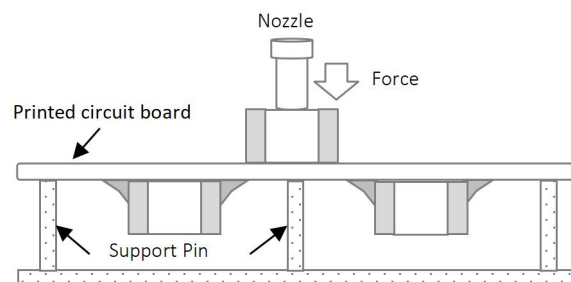

3. Suction nozzle

Dust accumulated in a suction nozzle and suction mechanism can impede a smooth movement of the nozzle. This may cause cracks in MLCC due to the excessive force during mounting.

If the mounting claw is worn out, it may cause cracks in MLCC due to the uneven force during positioning. A regular inspection such as maintenance, monitor and replacement for the suction nozzle and mounting claw should be conducted.

6.5 CAUTIONS FOR USING ELECTRICAL MEASURING PROBES

- Confirm the position of the support pin or jig when checking the electrical performance of MLCC after mounting on the PCB.
- Watch for PCB bending caused by the pressure of a test-probe or other equipment.
- If the PCB is bent by the force from the test probe, MLCC may be cracked or the solder joint may be damaged.
- Avoid PCB flexing by using the support pin on the back side of the PCB.
- Place equipment with the support pin as close to the test-probe as possible.
- Prevent shock vibrations of the board when the test-probe contacts a PCB.

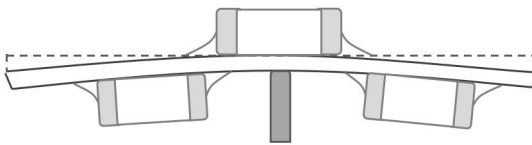

(Bad Example)

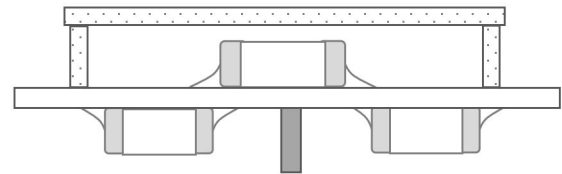

(Good Example)

6.6 PRINTED CIRCUIT BOARD CROPPING

1. Do not apply any stress to MLCC such as bending or twisting the board after mounting MLCC on the PCB.

The stress as shown may cause cracks in MLCC when cutting the board.

Cracked MLCC may cause degradation to the insulation resistance, thereby causing short circuit.

Avoid these types of stresses applied to MLCC.

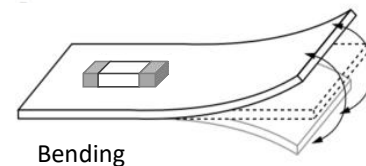

Bending

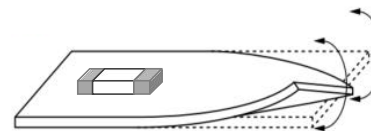

Twisting

2. Cautions for cutting PCB

Check a cutting method of PCB in advance.

The high density board is separated into many individual boards after the completion of soldering. If the board is bent or deformed during separation, MLCC may be cracked.

Carefully select a separation method that minimizes the deformation of the PCB.

6.7 ASSEMBLY HANDLING

1. Cautions for PCB handling

Hold the edges of the board mounted with MLCC with both hands since holding with one hand may bend the board.

Do not use dropped boards, which may degrade the quality of MLCC.

2. Mounting other components

Pay attention to the following conditions when mounting other components on the back side of The board after MLCC has been mounted on the front side.

When the suction nozzle is placed too close to the board, board deflection stress may be applied to MLCC on the back side, resulting in cracks in MLCC.

Check if proper value is set on each chip mounter for a suction location, a mounting gap and a suction gap by the thickness of components.

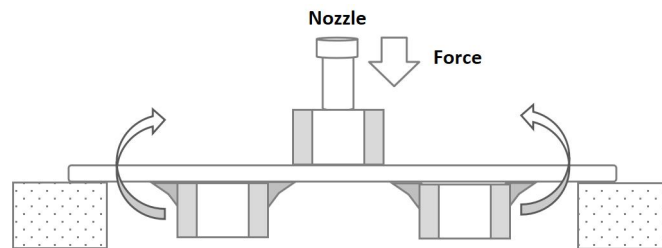

3. Board mounting components with leads

If the board is bent when inserting components (transformer, IC, etc.) into it, MLCC or solder joint may be cracked.

Pay attention to the following:

- Reduce the stress on the board during insertion by increasing the size of the lead insertion hole.
- Insert components with leads into the board after fixing the board with support pins or a dedicated jig.
- Support the bottom side of the board to avoid bending the board.
- Check the status of the height of each support pin regularly when the support pins are used.

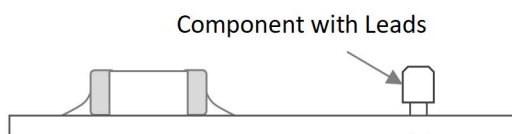

(Bad Example)

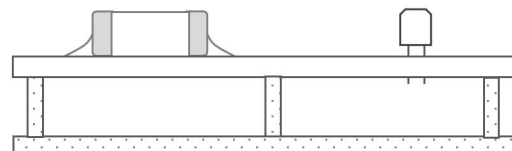

(Good Example)

4. Socket and / or connector attach / detach

Since the insertion or removal from sockets and connectors may cause the board to bend, make sure that MLCC mounted on the board should not be damaged in this process.

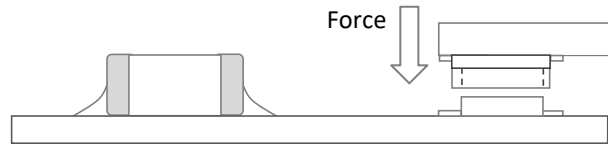

5. Fastening screw

When attaching a shield on a board, the board may be bent during a screw tightening work.

Pay attention to the following conditions before performing the work.

- Plan the work to prevent the board from bending.
- Use a torque driver to prevent over-tightening of the screw.
- Since the board may be bent by soldering, use caution in tightening the screw.

6.8 ADHESIVE SELECTION

Pay attention to the following if an adhesive is used to position MLCC on the board before soldering.

1. Requirements for Adhesives

- They must have enough adhesive strength to prevent MLCC from slipping or moving during the handling the board.
- They must maintain their adhesive strength when exposed to soldering temperatures.
- They should not spread when applied to the PCB.
- They should have a long pot life.
- They should be hardened quickly.
- They should not corrode the board or MLCC materials.
- They should be an insulator type that does not affect the characteristic of MLCC.
- They should be non-toxic, not harmful, and particularly safe when workers touch the adhesives

2. Caution before Applying Adhesive

Check the correct application conditions before attaching MLCC to the board with an adhesive.

If the dimension of land, the type of adhesives, the amount of coating, the contact surface areas, the curing temperature, or other conditions are not appropriate, it may degrade the MLCC performance.

3. Cautions for selecting Adhesive

Depending on the type of the chosen adhesive, MLCC insulation resistance may be degraded.

In addition, MLCC may be cracked by the difference in contractile stress caused by the different contraction rate between MLCC and the adhesive.

4. Cautions for the amount of applied adhesive and curing temperature

- The inappropriate amount of the adhesive cause the weak adhesive strength, resulting in the mounting defect in MLCC.
- Excessive use of the adhesive may cause a soldering defect, loss of electrical connection, incorrect curing, or slippage of a mounting position, thereby an inflow of the adhesive onto the land section should be avoided.
- If the curing temperature is too high or the curing time is too long, the adhesive strength will be degraded. In addition, oxidation both on the outer termination (Sn) of MLCC and the surface of the board may deteriorate the solderability

6.9 FLUX

1. The excessive amount of flux generates excessive flux gases which may deteriorate solderability. Therefore, apply the flux thin and evenly as a whole.
2. Flux with a high ratio of halogen may oxidize the outer termination of MLCC, if cleaning is not done properly. Therefore, use flux with a halogen content of 0.1% max.
3. Strong acidic flux can degrade the MLCC performance.
4. Check the solder quality of MLCC and the amount of remaining flux surrounding MLCC after the mounting process.

6.10 COATING

1. Crack caused by Coating

A crack may be caused in the MLCC due to amount of the resin and stress of thermal contraction of the resin during coating process.

During the coating process, the amount of resin and the stress of thermal contraction of the resin may cause cracks in MLCC.

The difference of thermal expansion coefficient between the coating, or a molding resin may cause destruction, deterioration of insulation resistance or dielectric breakdown of MLCC such as cracks or detachment, etc.

2. Recommended Coating material

- A thermal expansion coefficient should be as close to that of MLCC as possible.
- A silicone resin can be used as an under-coating to buffer the stress.
- The resin should have a minimum curing contraction rate.
- The resin should have a minimum sensitivity (ex. Epoxy resin).
- The insulation resistance of MLCC can be deteriorated if a high hygroscopic property resin is used in a high humidity condition.
- Do not use strong acid substances due to the fact that coating materials inducing a family of halogen substances and organic acid may corrode MLCC.

6.11 LAND DIMENSIONS

The recommended land dimension is determined by evaluating the actual SET and a board

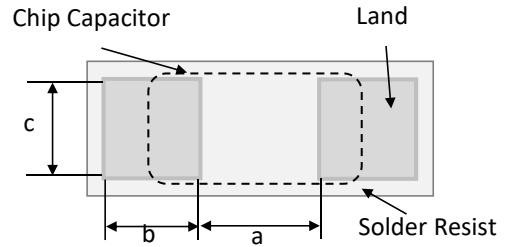
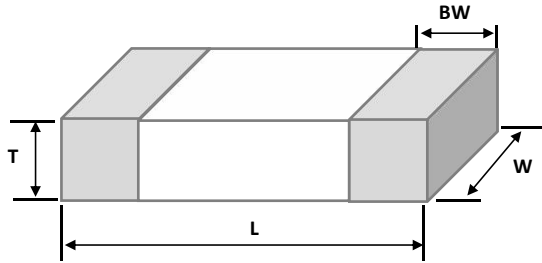

6.12 REFLOW FOOTPRINT

Size (inch)	L (mm)	W (mm)	SIZE TOLERANCE (mm)	a(mm)	b(mm)	c(mm)
0603	1.6	0.8	±0.10	0.63 ~ 0.73	0.71 ~ 0.81	0.80 ~ 0.90
	1.6	0.8	±0.15	0.65 ~ 0.75	0.73 ~ 0.83	0.90 ~ 1.00
	1.6	0.8	±0.20	0.67 ~ 0.77	0.74 ~ 0.84	0.95 ~ 1.05
	1.6	0.8	±0.25	0.69 ~ 0.79	0.76 ~ 0.86	1.00 ~ 1.10
	1.6	0.8	±0.30	0.71 ~ 0.81	0.77 ~ 0.87	1.05 ~ 1.15

6.13 OTHERS

Storage environment

1. Recommendation for temperature/humidity

Even taping and packaging materials are designed to endure a long-term storage, they should be stored with a temperature of 5~40°C and an RH of 20~70% otherwise, too high temperatures or humidity may deteriorate the quality of the product rapidly.

As oxidization is accelerated when relative humidity is above 70%RH, the lower the humidity is, the better the solderability is. As the temperature difference may cause dew condensation during the storage of the product, it is a must to maintain a temperature control environment.

2. Shelf Life

An allowable storage period should be within 6 months from the outgoing date of delivery in consideration of solderability.

As for products in storage over 6 months, please check solderability before use.

3. Moisture Sensitivity Level

MSL : Equal to LEVEL 1

Note : Baking is not required.

Caution for corrosive environment

As corrosive gases may deteriorate the solderability of MLCC outer termination, it is a must to store MLCC in an environment without gases. MLCC that is exposed to corrosive gases may cause its quality issues due to the corrosion of plating layers and the penetration of moisture.

Equipment in operation

1. Do not touch MLCC directly with bare hands to prevent an electric shock or damage.

2. The termination of MLCC shall not be contacted with a conductive object (short –circuit).
Do not expose MLCC to conductive liquid containing acidic or alkaline material.

3. Do not use the equipment in the following conditions.

- Exposure to water or oil
- Exposure to direct sunlight
- Exposure to Ozone or ultra-violet radiation.
- Exposure to corrosive gas (e.g. hydrogen sulfide, sulfur dioxide, chlorine, ammonia gas)
- Exposure to vibration or mechanical shock exceeding specified limit
- Exposure to high humidity

4. If the equipment starts generating any smoke, fire or smell, immediately switch it off or unplug from the power source.

If the equipment is not switched off or unplugged, serious damage may occur due to the continuous power supply. Please be careful with the high temperature in this condition.

6.14 WASTE TREATMENT

In case of scrapping MLCC, it is incinerated or buried by a licensed industrial waste company. When scrapping MLCC, it is recommended to incinerate or bury the scrapping by a licensed industrial waste company.

6.15 OPERATING TEMPERATURE

The operating temperature limit is determined by the specification of each models.

1. Do not use MLCC over the maximum operating temperature.

Pay attention to equipment' s temperature distribution and the seasonal fluctuation of ambient temperature.

2. The surface temperature of MLCC cannot exceed the maximum operating temperature including self-heating effects.

6.16 TRANSPORTATIONS

The performance of MLCC may be affected by transportation conditions.

1. MLCC shall be protected from excessive temperature, humidity and a mechanical force during transportation. During transportation, the cartons shall not be deformed and the inner packaging shall be protected from excessive external forces.

2. Do not apply excessive vibrations, shocks or excessive forces to MLCC.

- If excessive mechanical shock or stress are applied, MLCC' s ceramic body may crack.
- When the surface of MLCC is hit with the sharp edge of an air driver, a soldering iron, or a tweezer, etc, MLCC may crack or become short-circuited.

3. MLCC may crack and become non-functional due to the excessive shocks or dropping during transportation

7. PACKING

Dimensions of paper/PE tape for relevant chip capacitor size

PRODUCT SIZE CODE	SYMBOL										Unit: mm
	A0	B0	W	E	F	P0	P1	P2	ØD0	T	
0603	1.05±0.15	1.90±0.15	8.0±0.30	1.75±0.10	3.5±0.05	4.0±0.10	4.0±0.05	2.0±0.05	1.5+0.1/-0	1.00±0.10	

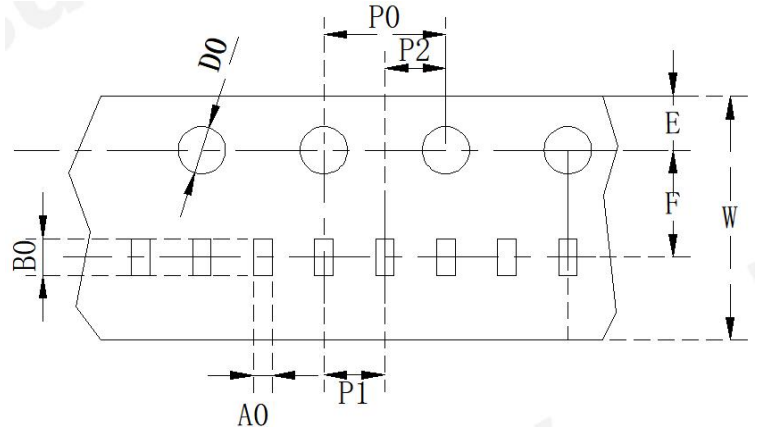
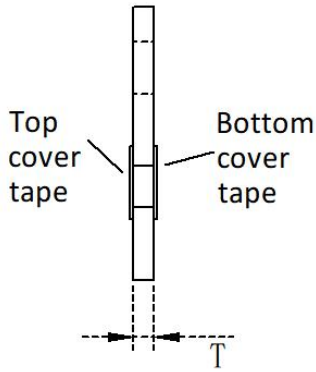

7.1 REEL SPECIFICATION

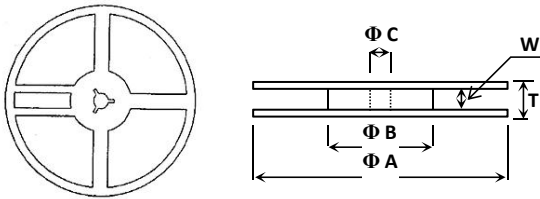

Reel	ψA	ψB	ψC	W	T
7" Reel	178±2.0	60±1.0	13.0±1.0	9.0±1.0	11.5±1.5

7.2 PEEL-OFF FORCE

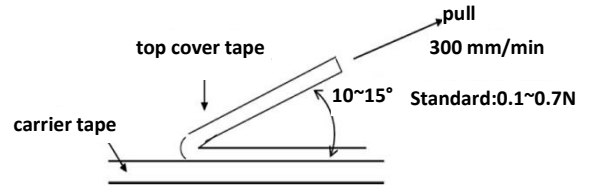

Unless otherwise specified, the cover tape shall be peeled from the carrier tape at a speed of 300 mm/min and an angle of 10° to 15°. The peel strength under these conditions shall be 0.1 ~ 0.7 N.

8. SUNWAY CONTACT

Asia

HQ Shenzhen China

No. 1013, Xihuan Road, Shajing Town,
Bao'an District, Shenzhen, China
Tel: +86-755-81773388
E-mail: Sales-south@sz-sunway.com

Shenzhen China

North third floor, block A, Tefa
information port, No. 2 Kefeng Road,
Science Park, Nanshan District,
Shenzhen, China
E-mail: Sales-south@sz-sunway.com

Beijing china

No.14, Jinxiu Street, Business
Development Area, Beijing, China
E-mail: Sales-east@sz-sunway.com

Shanghai China

Floor 1, Building 1, No. 2653 Hunan
Road, Pudong New Area, Shanghai,
China
E-mail: Sales-east@sz-sunway.com

Changzhou China

No.369 Jinlong Road, Jintan District,
Changzhou, China
E-mail: Sales-east@sz-sunway.com

Yiyang China

Yiyang High-tech Zone East Industrial
Park Standardized Plant, Yiyang, China
E-mail: Sales-east@sz-sunway.com

Mianyang china

No.268 Binhe North Road West Section,
High-tech Zone, Mianyang, China

Taiwan China

Floor 2, NO 637 Ruiguang Road, Neihu
District, Taipei City 114, Taiwan

Shin-Yokohama Japan

3rd floor-A, INTELLEX-Shin-Yokohama
building 1-17-12, Shin-yokohama,
Kohoku-ku, Yokohama-shi, Kanagawa,
Janpan

Suwon South Korea

101-801, Digital Empire 2, #88
Sinwon-road, Yeongtong-gu, Suwon-Si,
Gyeonggi-do, Korea

Vinh Phuc Vietnam

CNO8-2, Binh Xuyen 2 IP, Ba Hien, Binh
Xuyen, Vinh Phuc, Vietnam

Northern America

Cupertino USA

20040 Stevens Creek Blvd, Suite 100,
Cupertino, CA 95014, USA

San Diego USA

10180 Telesis Ct Suite 165/220, San
Diego, CA 92121, USA

Europe

Stockholm Sweden

Kistagangen 20BS-164 40 Kista, Sweden
Email: europe@sz-sunway.com