

VOLTAGE RANGE

20 to 100 Volts

CURRENT

2.0 Ampere

FEATURES

- * Ideal for surface mount applications
- * Easy pick and place
- * Built-in strain relief
- * Low forward voltage drop

MECHANICAL DATA

- * Case: Molded plastic
- * Epoxy: UL 94V-0 rate flame retardant
- * Terminals: Solder plated, solderable per MIL-STD-202F method 208 guaranteed
- * Polarity: Color band denotes cathode end
- * Mounting position: Any

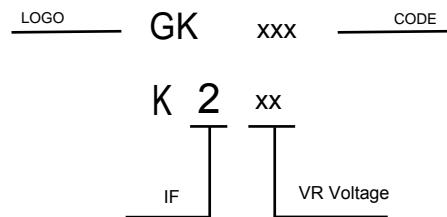

MAXIMUM RATINGS AND ELECTRICAL CHARACTERISTICS

Rating 25°C ambient temperature unless otherwise specified.
Single phase half wave, 60Hz, resistive or inductive load.
For capacitive load, derate current by 20%.

TYPE NUMBER	DSS22	DSS23	DSS24	DSS25	DSS26	DSS28	DSS29	DSS210	UNITS
Maximum Recurrent Peak Reverse Voltage	20	30	40	50	60	80	90	100	V
Maximum RMS Voltage	14	21	28	35	42	56	63	70	V
Maximum DC Blocking Voltage	20	30	40	50	60	80	90	100	V
Maximum Average Forward Rectified Current See Fig. 1	2.0								A
Peak Forward Surge Current, 8.3 ms single half sine-wave superimposed on rated load (JEDEC method)	50								A
Maximum Instantaneous Forward Voltage at 2.0A	0.55		0.70		0.85				V
Maximum DC Reverse Current Ta=25°C	0.1			0.02				mA	
at Rated DC Blocking Voltage Ta=100°C	5			2				mA	
Typical Junction Capacitance (Note1)	170								pF
Typical Thermal Resistance R _{JA} (Note 2)	80								°C/W
Operating Temperature Range T _J	-65 — +150								°C
Storage Temperature Range T _{STG}	-65 — +150								°C

NOTES:

1. Measured at 1MHz and applied reverse voltage of 4.0V D.C.
2. Thermal Resistance Junction to Ambient.

RATING AND CHARACTERISTIC CURVES

FIG.1-TYPICAL FORWARD CURRENT DERATING CURVE

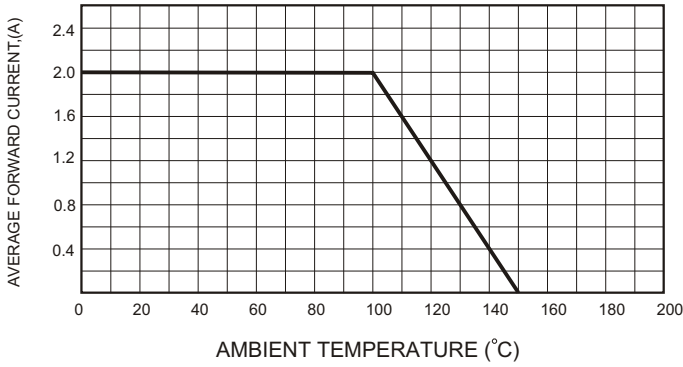

FIG.2-TYPICAL FORWARD CHARACTERISTICS

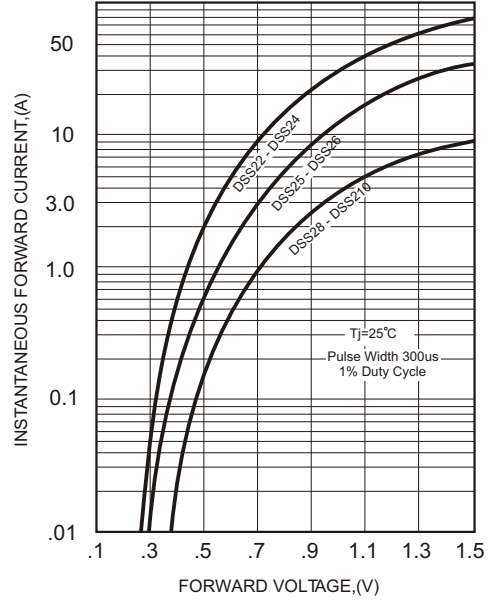

FIG.3 - TYPICAL REVERSE CHARACTERISTICS

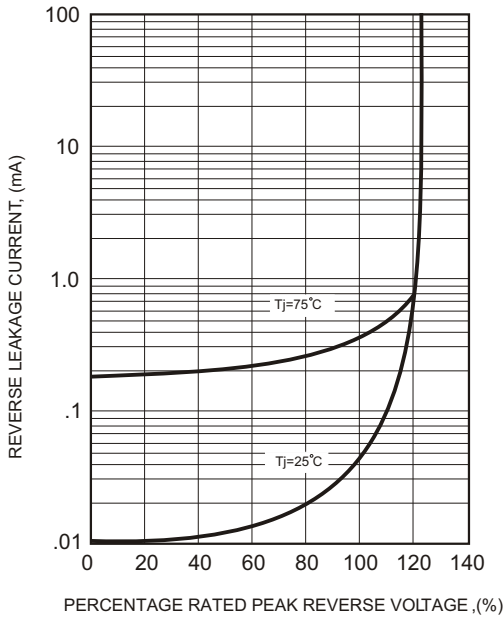

FIG.4-MAXIMUM NON-REPETITIVE FORWARD SURGE CURRENT

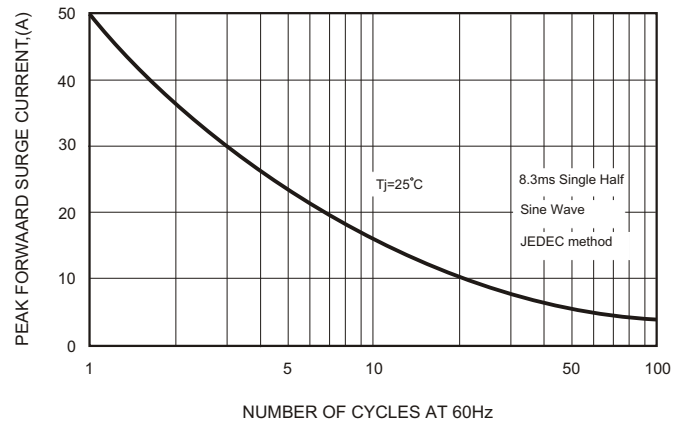
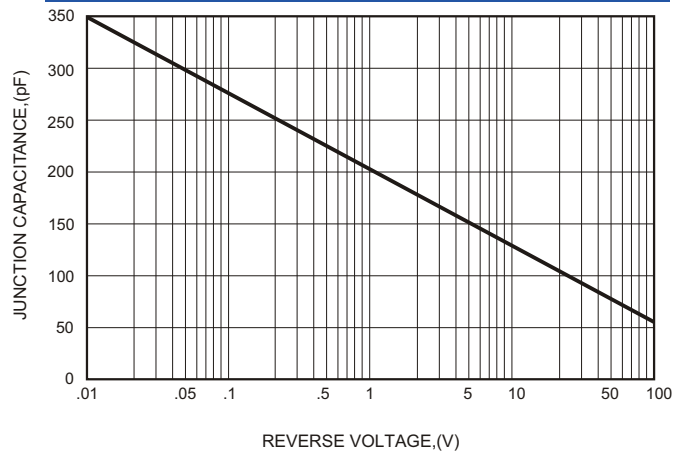

FIG.5-TYPICAL JUNCTION CAPACITANCE



Soldering parameters

Reflow Condition		Pb-Free assembly (see as below)
Pre Heat	-Temperature Min ($T_{s(min)}$)	+150 °C
	-Temperature Max($T_{s(max)}$)	+200 °C
	-Time (Min to Max) (ts)	60-180 secs.
Average ramp up rate (Liquid us Temp (T_L) to peak)		3 °C/sec. Max
$T_{s(max)}$ to T_L - Ramp-up Rate		3 °C/sec. Max
Reflow	-Temperature(T_L)(Liquid us)	+217 °C
	-Temperature(t_L)	60-150 secs.
Peak Temp (T_P)		+260(+0/-5) °C
Time within 5 °C of actual Peak Temp (t_p)		30 secs. Max
Ramp-down Rate		6 °C/sec. Max
Time 25 °C to Peak Temp (T_P)		8 min. Max
Do not exceed		+260 °C



Package Dimensions & Suggested Pad Layout

SOD123FL

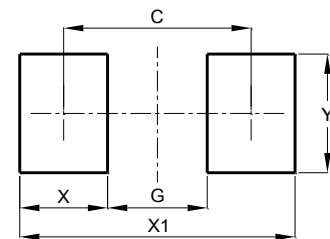
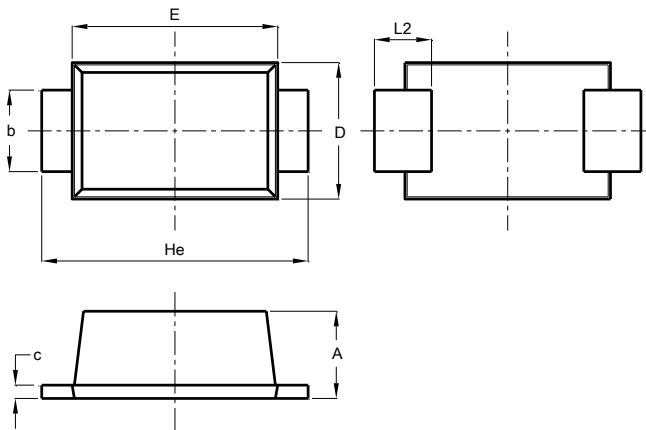

SOD123FL		
Dim	Min	Max
A	1.00	1.20
b	0.80	1.10
c	0.12	0.20
D	1.75	1.95
E	2.60	2.90
He	3.55	3.80
L2	0.50	0.85

All Dimensions in mm

Dimensions	Value (in mm)
C	3.25
G	2.00
X	1.25
X1	4.50
Y	1.50

Tape & reel specification

Tape

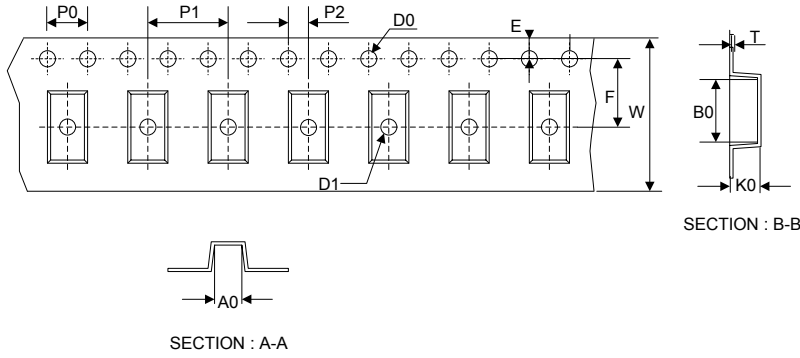

7" Reel

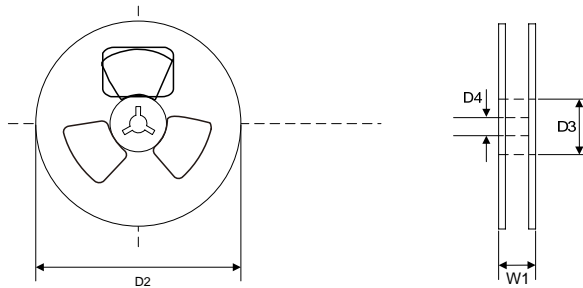

Symbol	Dimension (mm)
--------	----------------

P0	4.00±0.20
----	-----------

P1	4.00±0.20
----	-----------

P2	2.00±0.20
----	-----------

D0	1.55±0.15
----	-----------

D1	1.00±0.20
----	-----------

E	1.75±0.20
---	-----------

F	3.50±0.25
---	-----------

W	8.00±0.20
---	-----------

A0	1.85±0.20
----	-----------

B0	3.95±0.20
----	-----------

K0	1.30±0.20
----	-----------

T	0.21±0.10
---	-----------

D2	178.0±5.0
----	-----------

D3	55.0Min.
----	----------

D4	10.0±2.5
----	----------

W1	11.5±2.5
----	----------

Quantity: 3000PCS