

REV.	REVISION DESCRIPTION	DATE	APPD

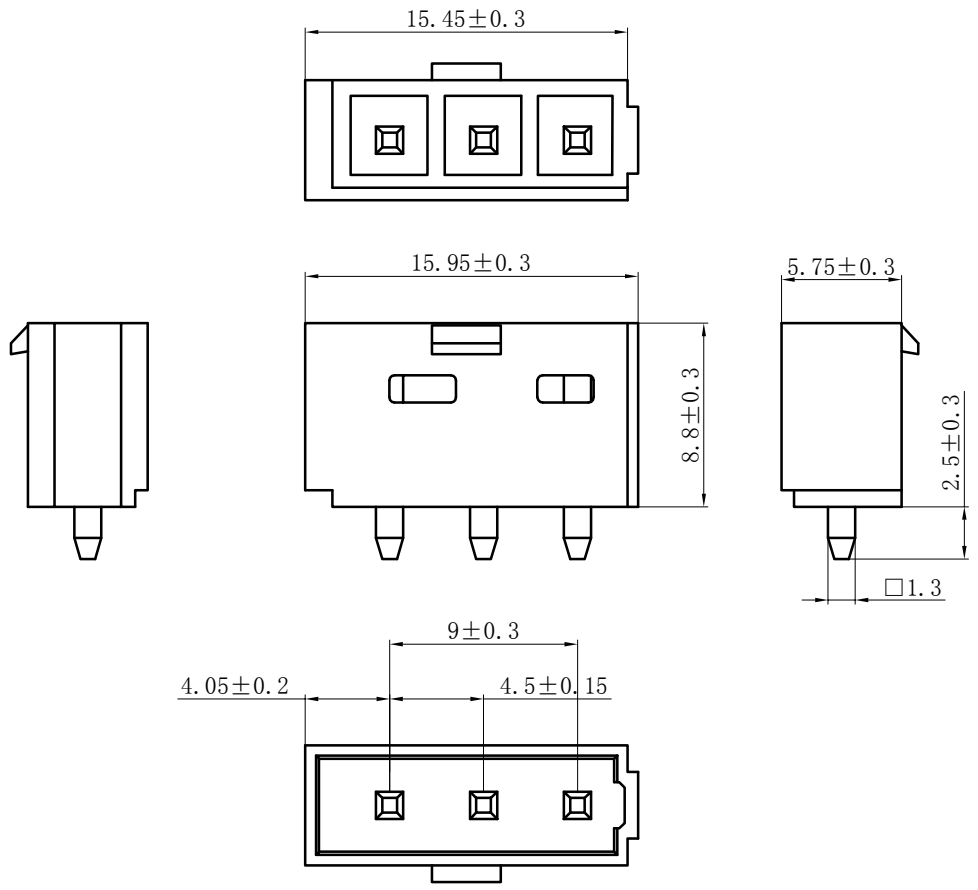

NOTES:

- Rated voltage: 250V AC/DC
- Rated current: 20A AC/DC (AWG#16)
- Contact resistance: ≤ 5 m Ω
- Insulation resistance: ≥ 800 M Ω
- Withstand voltage: 800V AC/minute
- Ambient temperature: $-40^{\circ}\text{C} \sim +105^{\circ}\text{C}$
- Material: LCP UL94V-0.
- Pin Materials: Copper alloy / Gold-Plated.

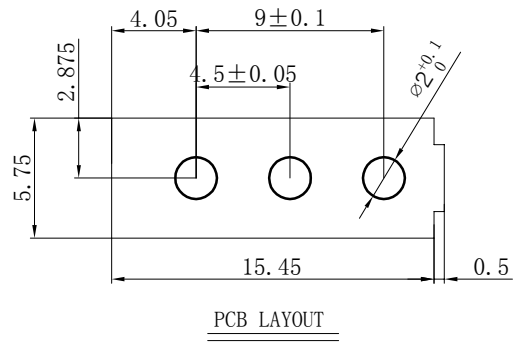

GENERAL TOLERANCES (UNLESS SPECIFIED)		ZHE JIANG DELI CONNECTORS CO., LTD	
.X: ± 0.25	X°: $\pm 3.0^{\circ}$	PRODUCT NAME: QADC-3AK	TITLE: 4.5mm Pitch Wire To Board Wafer
.XX: ± 0.15	.X°: $\pm 2.0^{\circ}$	DR:Chen Quan Long	DATE:26/01/23
.XXX: ± 0.01	.XX°: $\pm 1.0^{\circ}$	CHKD: Wu Hui	DATE:26/01/23
DRAWING NO:		APPD:Ren An De	DATE:26/01/23
		SCALE: N/A	PAGE: 1/1
		UNITS: mm	REV.: A

REV.	REVISION DESCRIPTION	DATE	APPD

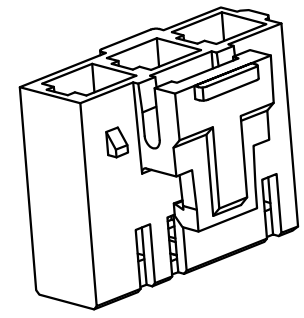
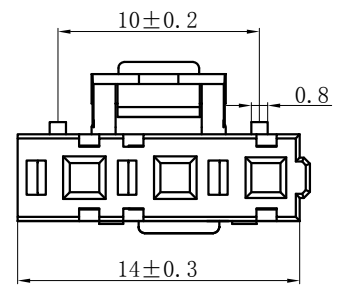

- NOTES:
1. Rated voltage: 250V AC. DC
 2. Rated current: 20A AC DC (AWG#16)
 3. Contact resistance: $\leq 5 \text{ m}\Omega$
 4. Insulation resistance: $\geq 800 \text{ M}\Omega$
 5. Withstand voltage: 800V AC/minute
 6. Ambient temperature: $-40^\circ\text{C} \sim +105^\circ\text{C}$
 7. Material : PA66 UL94V-0 750°C.
 8. Matched RoHS criteria

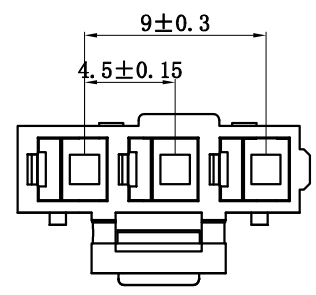
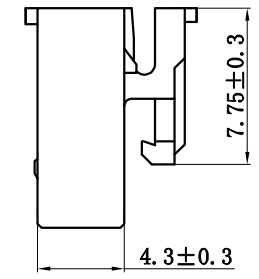
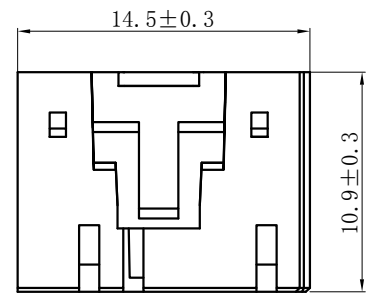
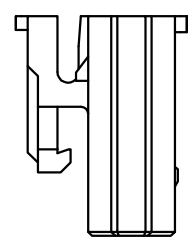

GENERAL TOLERANCES (UNLESS SPECIFIED)		ZHE JIANG DELI CONNECTORS CO., LTD	
.X: ± 0.25	X°: $\pm 3.0^\circ$	PRODUCT NAME: QADC-3YK	TITLE: 4.5mm Pitch Housing
.XX: ± 0.15	.X°: $\pm 2.0^\circ$	DR: Chen Quan Long	DATE: 26/01/23
.XXX: ± 0.01	.XX°: $\pm 1.0^\circ$	CHKD: Wu Hui	DATE: 26/01/23
FINISH:		APPD: Ren An De	DATE: 26/01/23
DRAWING NO:		SCALE: N/A	PAGE: 1/1
		UNITS: mm	REV.: A

REV.	REVISION DESCRIPTION	DATE	APPD

NOTES:

1. Rated voltage: 250V AC.DC
2. Rated current: 20A AC DC(AWG#16)
3. Contact resistance: $\leq 5 \text{ m}\Omega$
4. Insulation resistance: $\geq 800 \text{ M}\Omega$
5. Withstand voltage: 800V AC/minute
6. Ambient temperature: $-40^{\circ}\text{C} \sim +105^{\circ}\text{C}$
7. Material : PA66 UL94V-0 750°C
8. Matched RoHS criteria

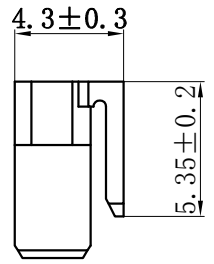
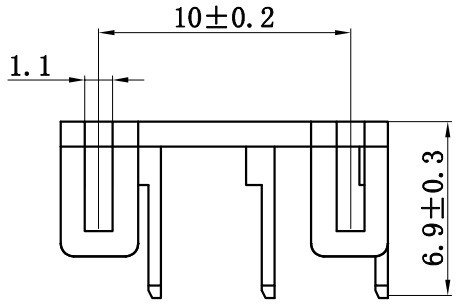
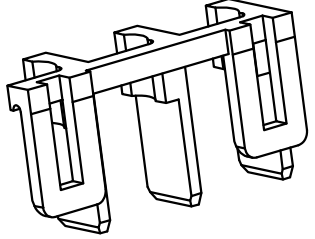
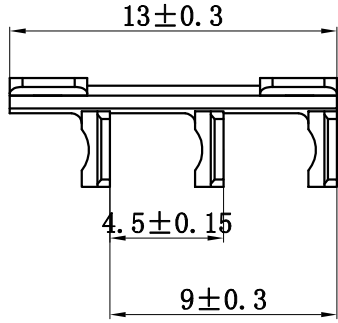

GENERAL TOLERANCES (UNLESS SPECIFIED)		ZHE JIANG DELI CONNECTORS CO., LTD	
.X: ± 0.25	X° : $\pm 3.0^{\circ}$	PRODUCT NAME: QADC-3S	TITLE: 4.5mm Pitch Housing
.XX: ± 0.15	.X° : $\pm 2.0^{\circ}$	DR: Chen Quan Long	DATE:26/01/23
.XXX: ± 0.01	.XX° : $\pm 1.0^{\circ}$	CHKD: Wu Hui	DATE:26/01/23
FINISH:		APPD: Ren An De	DATE:26/01/23
DRAWING NO:		SCALE: N/A	PAGE: 1/1
		UNITS: mm	REV.: A

REV.	REVISION DESCRIPTION	DATE	APPD

NOTES:
 Rated voltage: 250V AC.DC
 Rated current: 20A AC DC(AWG#16)
 Contact resistance: $\leq 5 \text{ m}\Omega$
 Insulation resistance: $\geq 800 \text{ M}\Omega$
 Withstand voltage: 800V AC/minute
 Ambient temperature: $-40^{\circ}\text{C} \sim +105^{\circ}\text{C}$
 Wire range: AWG#20~#16
 Materials: Copper alloy, Gold plated

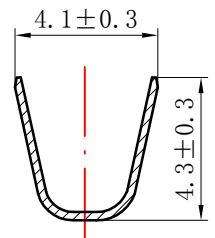
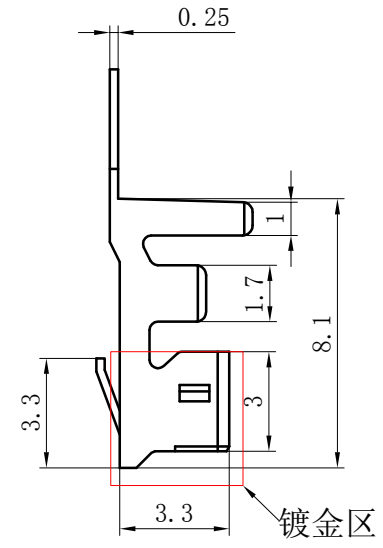
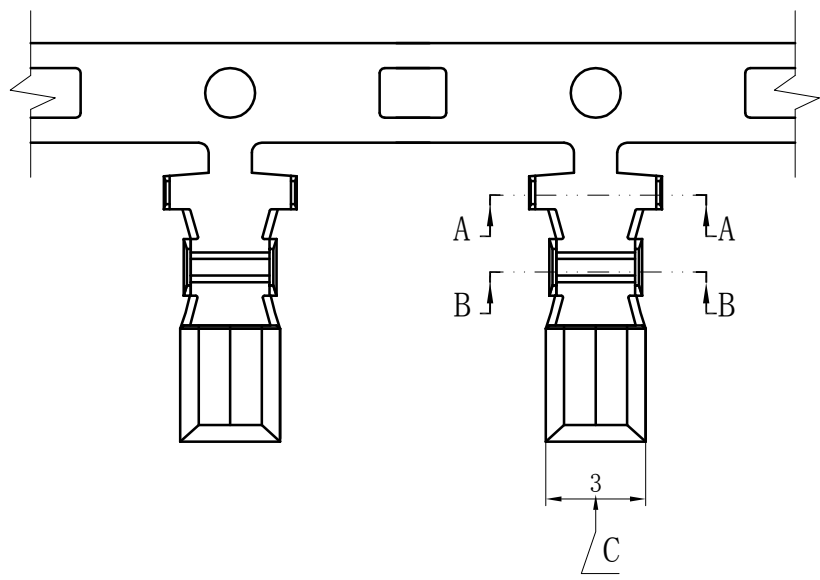

SECTION A-A

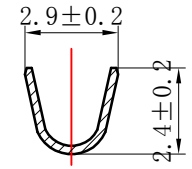

SECTION B-B

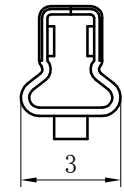

C向

GENERAL TOLERANCES (UNLESS SPECIFIED)		ZHE JIANG DELI CONNECTORS CO., LTD	
.X: ± 0.25	X°: $\pm 3.0^{\circ}$	PRODUCT NAME: QADC-T	TITLE: 4.5 mm Pitch Crimp Terminal
.XX: ± 0.15	.X°: $\pm 2.0^{\circ}$	DR: Chen Quan Long	DATE: 25/08/01
.XXX: ± 0.01	.XX°: $\pm 1.0^{\circ}$	APPD: Ren An De	DATE: 25/08/01
FINISH:		CHKD: Wu Hui	DATE: 25/08/01
DRAWING NO:		SCALE: N/A	PAGE: 1/1
		UNITS: mm	REV.: A