

相邻端子指尖处歪斜不大于 0.10mm

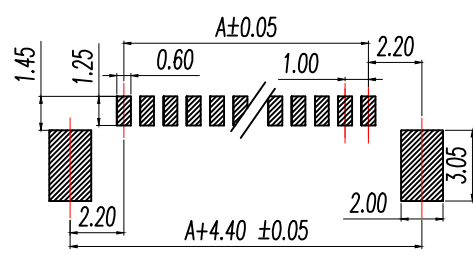
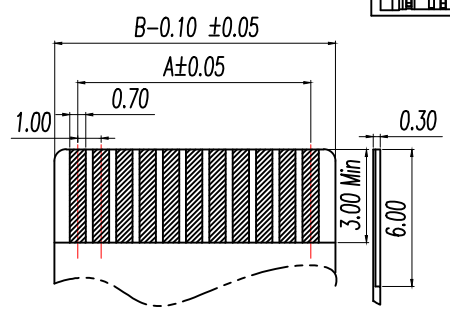
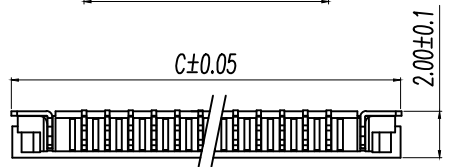
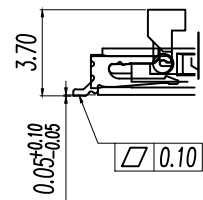
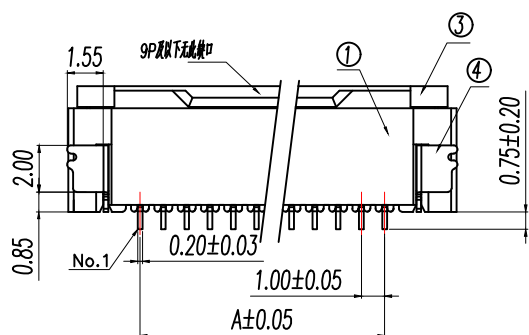
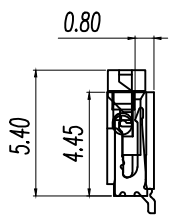
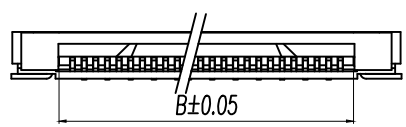
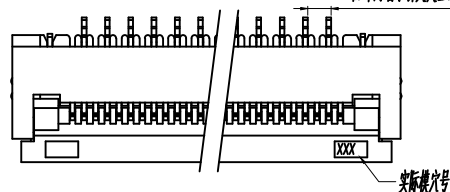

适用FFC长度  
Applicable FFC

PCB 长度  
PCB Layout 公差: ±0.05mm

NOTES:  
额定电流 Current rating: 0.5A  
额定电压 Voltage rating: 50V  
耐电压 Withstand voltage: 500V AC/minute  
接触电阻 Contact resistance: <40mΩ  
绝缘电阻 Insulation resistance: 100MΩ MIN  
工作温度 Working temperature: -25℃ ~ +85℃  
插针间距 PIN间距0.05mm.

4	1.0mm间距C型插盖式下接—焊片	PhosphorBronze T=0.20MM	镀锡	1 PCS	左/右插
3	1.0mm间距C型插盖式下接—焊钉	LCP	镀银	1 PCS	
2	1.0mm间距C型插盖式下接—PIN	PhosphorBronze T=0.20MM	镀锡/镀金/镀银	N PCS	
1	1.0mm间距C型插盖式下接—基座	LCP	镀银	1 PCS	n*2+1 P
序号	品名	材料规格	电镀方式/颜色	使用数量	备注

Part No	Pin	A	B	C
BX-FPC1.0-2H2PX	2	1.00	3.10	7.20
BX-FPC1.0-2H3PX	3	2.00	4.10	8.20
BX-FPC1.0-2H4PX	4	3.00	5.10	9.20
BX-FPC1.0-2H5PX	5	4.00	6.10	10.20
BX-FPC1.0-2H6PX	6	5.00	7.10	11.20
BX-FPC1.0-2H7PX	7	6.00	8.10	12.20
BX-FPC1.0-2H8PX	8	7.00	9.10	13.20
BX-FPC1.0-2H9PX	9	8.00	10.10	14.20
BX-FPC1.0-2H10PX	10	9.00	11.10	15.20
BX-FPC1.0-2H11PX	11	10.00	12.10	16.20
BX-FPC1.0-2H12PX	12	11.00	13.10	17.20
BX-FPC1.0-2H13PX	13	12.00	14.10	18.20
BX-FPC1.0-2H14PX	14	13.00	15.10	19.20
BX-FPC1.0-2H15PX	15	14.00	16.10	20.20
BX-FPC1.0-2H16PX	16	15.00	17.10	21.20
BX-FPC1.0-2H17PX	17	16.00	18.10	22.20
BX-FPC1.0-2H18PX	18	17.00	19.10	23.20
BX-FPC1.0-2H19PX	19	18.00	20.10	24.20
BX-FPC1.0-2H20PX	20	19.00	21.10	25.20
BX-FPC1.0-2H21PX	21	20.00	22.10	26.20
BX-FPC1.0-2H22PX	22	21.00	23.10	27.20
BX-FPC1.0-2H23PX	23	22.00	24.10	28.20
BX-FPC1.0-2H24PX	24	23.00	25.10	29.20
BX-FPC1.0-2H25PX	25	24.00	16.10	30.20
BX-FPC1.0-2H26PX	26	25.00	27.10	31.20
BX-FPC1.0-2H27PX	27	26.00	28.10	33.20
BX-FPC1.0-2H28PX	28	27.00	29.10	34.20
BX-FPC1.0-2H29PX	29	28.00	30.10	35.20
BX-FPC1.0-2H30PX	30	29.00	31.10	36.20
BX-FPC1.0-2H31PX	31	30.00	32.10	37.20

制图 DRAWN	标题栏 DESCRIPTION	日期 DATE	GENERAL TOLERANCE		制图 DRAWING	EMMA		料号 PART NO.	BX-FPC1.0-2HNPX	版次 REV.	A								
			X.±0.38	X.'±5°		审核 CHECK	EVA					品名 TITLE	1.0mm间距C型插盖式下接	页次 SHEET	1/1				
			.X±0.20	.X'±3°			批准 APPROVAL									JADE		料号 CUTM.NO.	
			.XX±0.05	.XX'±1°												UNIT	比例 SCALE		