

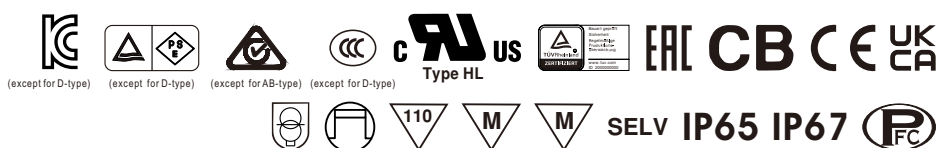

185W Constant Voltage + Constant Current LED Driver

# HLG-185H series

User's Manual



## ■ Features

- Constant Voltage + Constant Current mode output
- Metal housing with class I design
- IP67 / IP65 rating for indoor or outdoor installations
- Function options: output adjustable via potentiometer; 3 in 1 dimming
- Typical lifetime > 62000 hours
- 7 years warranty

## ■ Applications

- LED street lighting
- LED high-bay lighting
- Parking space lighting
- LED fishing lamp
- LED greenhouse lighting
- Type "HL" for use in Class I , Division 2 hazardous (Classified) location.

## ■ Description

HLG-185H series is a 185W AC/DC LED driver featuring the dual mode constant voltage and constant current output. HLG-185H operates from 90 ~ 305VAC and offers models with different rated voltage ranging between 12V and 54V. Thanks to the high efficiency up to 94%, with the fanless design, the entire series is able to operate for -40°C ~ +90°C case temperature under free air convection. The design of metal housing and IP67/IP65 ingress protection level allows this series to fit both indoor and outdoor applications. HLG-185H is equipped with various function options, such as dimming methodologies, so as to provide the optimal design flexibility for LED lighting system.

## ■ GTIN CODE

MW Search: <https://www.meanwell.com/serviceGTIN.aspx>

## ■ Model Encoding

**HLG - 185H - 24 A**

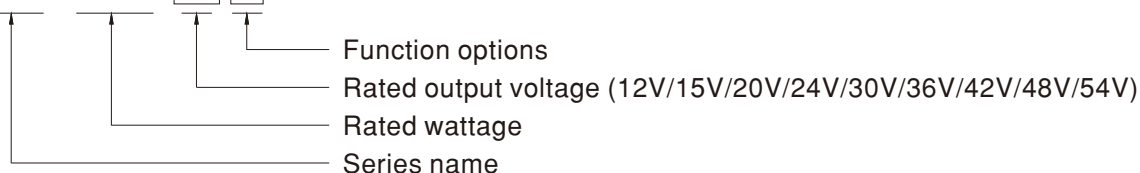

| Type  | IP Level | Function   | Note       |
|-------|----------|--|------------|
| Blank | IP67     | Io and Vo fixed  | In Stock   |
| A     | IP65     | Io and Vo adjustable through built-in potentiometer  | In Stock   |
| B     | IP67     | 3 in 1 dimming function (1~10VDC, 10V PWM signal and resistance)   | In Stock   |
| AB    | IP65     | Io and Vo adjustable through built-in potentiometer & 3 in 1 dimming function (1~10Vdc, 10V PWM signal and resistance) | In Stock   |
| D     | IP67     | Timer dimming function, contact MEAN WELL for details(safety pending).   | By request |

**SPECIFICATION**

| MODEL  |   | HLG-185H-12  | HLG-185H-15   | HLG-185H-20   | HLG-185H-24   | HLG-185H-30 | HLG-185H-36 | HLG-185H-42 | HLG-185H-48 | HLG-185H-54  |  |
|--|---|--|---------------|---------------|---------------|-------------|-------------|-------------|-------------|--------------|--|
| OUTPUT   | DC VOLTAGE  | 12V  | 15V           | 20V           | 24V           | 30V         | 36V         | 42V         | 48V         | 54V          |  |
|  | CONSTANT CURRENT REGION <small>Note.4</small>   | 6 ~ 12V  | 7.5 ~ 15V     | 10 ~ 20V      | 12 ~ 24V      | 15 ~ 30V    | 18 ~ 36V    | 21 ~ 42V    | 24 ~ 48V    | 27 ~ 54V     |  |
|  | RATED CURRENT   | 13A  | 11.5A         | 9.3A          | 7.8A          | 6.2A        | 5.2A        | 4.4A        | 3.9A        | 3.45A        |  |
|  | RATED POWER   | 156W   | 172.5W        | 186W          | 187.2W        | 186W        | 187.2W      | 184.8W      | 187.2W      | 186.3W       |  |
|  | RIPPLE & NOISE (max.) <small>Note.2</small>   | 150mVp-p   | 150mVp-p      | 150mVp-p      | 150mVp-p      | 200mVp-p    | 200mVp-p    | 200mVp-p    | 200mVp-p    | 200mVp-p     |  |
|  | VOLTAGE ADJ. RANGE  | Adjustable for A/AB-Type only (via built-in potentiometer)   |               |               |               |             |             |             |             |              |  |
|  |   | 10.8 ~ 13.5V   | 13.5 ~ 17V    | 17 ~ 22V      | 22 ~ 27V      | 27 ~ 33V    | 33 ~ 40V    | 38 ~ 46V    | 43 ~ 53V    | 49 ~ 58V     |  |
|  | CURRENT ADJ. RANGE  | Adjustable for A/AB-Type only (via built-in potentiometer)   |               |               |               |             |             |             |             |              |  |
|  |   | 6.5 ~ 13A  | 5.75 ~ 11.5A  | 4.65 ~ 9.3A   | 3.9 ~ 7.8A    | 3.1 ~ 6.2A  | 2.6 ~ 5.2A  | 2.2 ~ 4.4A  | 1.95 ~ 3.9A | 1.72 ~ 3.45A |  |
|  | VOLTAGE TOLERANCE <small>Note.3</small>   | ± 2.5%   | ± 2.0%        | ± 1.0%        | ± 1.0%        | ± 1.0%      | ± 1.0%      | ± 1.0%      | ± 1.0%      | ± 1.0%       |  |
|  | LINE REGULATION   | ± 0.5%   | ± 0.5%        | ± 0.5%        | ± 0.5%        | ± 0.5%      | ± 0.5%      | ± 0.5%      | ± 0.5%      | ± 0.5%       |  |
| LOAD REGULATION  | ± 2.0%  | ± 1.5%   | ± 1.0%        | ± 0.5%        | ± 0.5%        | ± 0.5%      | ± 0.5%      | ± 0.5%      | ± 0.5%      |              |  |
| SETUP, RISE TIME <small>Note.6</small>   | 1000ms,200ms/115VAC 500ms,200ms/230VAC  |  |               |               |               |             |             |             |             |              |  |
| HOLD UP TIME (Typ.)  | 16ms / 115VAC, 230VAC   |  |               |               |               |             |             |             |             |              |  |
| INPUT  | VOLTAGE RANGE <small>Note.5</small>   | 90 ~ 305VAC 127 ~ 431VDC<br>(Please refer to "STATIC CHARACTERISTIC" section)  |               |               |               |             |             |             |             |              |  |
|  | FREQUENCY RANGE   | 47 ~ 63Hz  |               |               |               |             |             |             |             |              |  |
|  | POWER FACTOR (Typ.)   | PF ≥ 0.98/115VAC, PF ≥ 0.95/230VAC, PF ≥ 0.92/277VAC @ full load<br>(Please refer to "POWER FACTOR (PF) CHARACTERISTIC" section)   |               |               |               |             |             |             |             |              |  |
|  | TOTAL HARMONIC DISTORTION   | THD < 20% (@ load ≥ 50% / 115VAC, 230VAC; @ load ≥ 75% / 277VAC)<br>(Please refer to "TOTAL HARMONIC DISTORTION (THD)" section)  |               |               |               |             |             |             |             |              |  |
|  | EFFICIENCY (Typ.)   | 91.5%  | 92%           | 93%           | 93.5%         | 93.5%       | 93.5%       | 94%         | 94%         | 94%          |  |
|  | AC CURRENT (Typ.)   | 12V  | 1.8A / 115VAC | 0.8A / 230VAC | 0.7A / 277VAC |             |             |             |             |              |  |
|  |   | 15V ~ 54V  | 2.1A / 115VAC | 0.9A / 230VAC | 0.8A / 277VAC |             |             |             |             |              |  |
|  | INRUSH CURRENT (Typ.)   | COLD START 65A (width=445μs measured at 50% I <sub>peak</sub> ) at 230VAC; Per NEMA 410  |               |               |               |             |             |             |             |              |  |
|  | MAX. No. of PSUs on 16A CIRCUIT BREAKER   | 4 units (circuit breaker of type B) / 7 units (circuit breaker of type C) at 230VAC  |               |               |               |             |             |             |             |              |  |
|  | LEAKAGE CURRENT   | < 0.75mA / 277VAC  |               |               |               |             |             |             |             |              |  |
| PROTECTION   | OVER CURRENT  | 95 ~ 108%<br>Constant current limiting, recovers automatically after fault condition is removed  |               |               |               |             |             |             |             |              |  |
|  | SHORT CIRCUIT   | Constant current limiting, recovers automatically after fault condition is removed   |               |               |               |             |             |             |             |              |  |
|  | OVER VOLTAGE  | 14 ~ 17V   | 18 ~ 21V      | 23 ~ 27V      | 28 ~ 34V      | 34 ~ 38V    | 41 ~ 46V    | 47 ~ 53V    | 54 ~ 63V    | 59 ~ 65V     |  |
|  |   | Shut down o/p voltage with auto-recovery or re-power on to recovery  |               |               |               |             |             |             |             |              |  |
|  | OVER TEMPERATURE <small>Note.9</small>  | Shut down o/p voltage, recovers automatically after temperature goes down  |               |               |               |             |             |             |             |              |  |
| ENVIRONMENT  | WORKING TEMP.   | T <sub>case</sub> = -40 ~ +90°C (Please refer to "OUTPUT LOAD vs TEMPERATURE" section)   |               |               |               |             |             |             |             |              |  |
|  | MAX. CASE TEMP.   | T <sub>case</sub> = +90°C  |               |               |               |             |             |             |             |              |  |
|  | WORKING HUMIDITY  | 20 ~ 95% RH non-condensing   |               |               |               |             |             |             |             |              |  |
|  | STORAGE TEMP., HUMIDITY   | -40 ~ +80°C, 10 ~ 95% RH   |               |               |               |             |             |             |             |              |  |
|  | TEMP. COEFFICIENT   | ± 0.03%/°C (0 ~ 60°C)  |               |               |               |             |             |             |             |              |  |
| SAFETY & EMC   | VIBRATION   | 10 ~ 500Hz, 5G 12min./1cycle, period for 72min. each along X, Y, Z axes  |               |               |               |             |             |             |             |              |  |
|  | SAFETY STANDARDS  | UL8750(type"HL"), CSA C22.2 No. 250.0-08; BS EN/EN 61347-1, BS EN/EN 61347-2-13, AS/NZS 61347-1(except for AB-type), AS/NZS 61347-2-13(except for AB-type) independent; GB/T19510.1, GB/T19510.213 (except for D-type); IP65 or IP67; J61347-1, J61347-2-13(except for D-type), EAC TP TC 004, KC61347-1, KC61347-2-13(except for D-type) approved |               |               |               |             |             |             |             |              |  |
|  | WITHSTAND VOLTAGE   | I/P-O/P: 3.75KVAC I/P-FG: 2KVAC O/P-FG: 1.5KVAC  |               |               |               |             |             |             |             |              |  |
|  | ISOLATION RESISTANCE  | I/P-O/P, I/P-FG, O/P-FG: 100M Ohms / 500VDC / 25°C / 70% RH  |               |               |               |             |             |             |             |              |  |
|  | EMC EMISSION  | Compliance to BS EN/EN55015, BS EN/EN55032 (CISPR32) Class B, BS EN/EN61000-3-2 Class C (@ load ≥ 50%); BS EN/EN61000-3-3, GB/T 17743, GB17625.1(except for D-type), EAC TP TC 020, KSC 9815(except for D-type)  |               |               |               |             |             |             |             |              |  |
| OTHERS   | EMC IMMUNITY  | Compliance to BS EN/EN61000-4-2, 3, 4, 5, 6, 8, 11, BS EN/EN61547, BS EN/EN55024, light industry level (surge immunity Line-Earth 4KV, Line-Line 2KV), EAC TP TC 020, KSC 9547(except for D-type)  |               |               |               |             |             |             |             |              |  |
|  | MTBF  | 2184.8K hrs min. Telcordia SR-332 (Bellcore); 197.3K hrs min. MIL-HDBK-217F (25°C)   |               |               |               |             |             |             |             |              |  |
|  | DIMENSION   | 228*68*38.8mm (L*W*H)  |               |               |               |             |             |             |             |              |  |
|  | PACKING   | 1.15Kg; 12pcs/14.8Kg/0.8CUFT   |               |               |               |             |             |             |             |              |  |
| NOTE   | <ol style="list-style-type: none"> <li>All parameters NOT specially mentioned are measured at 230VAC input, rated current and 25°C of ambient temperature.</li> <li>Ripple &amp; noise are measured at 20MHz of bandwidth by using a 12" twisted pair-wire terminated with a 0.1uF &amp; 47uF parallel capacitor.</li> <li>Tolerance : includes set up tolerance, line regulation and load regulation.</li> <li>Please refer to "DRIVING METHODS OF LED MODULE".</li> <li>De-rating may be needed under low input voltages. Please refer to "STATIC CHARACTERISTIC" sections for details.</li> <li>Length of set up time is measured at first cold start. Turning ON/OFF the driver may lead to increase of the set up time.</li> <li>The driver is considered as a component that will be operated in combination with final equipment. Since EMC performance will be affected by the complete installation, the final equipment manufacturers must re-qualify EMC Directive on the complete installation again. (as available on <a href="https://www.meanwell.com/Upload/PDF/EMI_statement_en.pdf">https://www.meanwell.com/Upload/PDF/EMI_statement_en.pdf</a>)</li> <li>To fulfill requirements of the latest ErP regulation for lighting fixtures, this LED driver can only be used behind a switch without permanently connected to the mains.</li> <li>For OTP which triggered at light load/no load condition, proceed AC repower on to recovery.</li> <li>This series meets the typical life expectancy of &gt;62,000 hours of operation when T<sub>case</sub>, particularly (T<sub>c</sub>) point (or TMP, per DLC), is about 75°C or less.</li> <li>Please refer to the warranty statement on MEAN WELL's website at <a href="http://www.meanwell.com">http://www.meanwell.com</a>.</li> <li>The ambient temperature derating of 3.5°C/1000m with fanless models and of 5°C/1000m with fan models for operating altitude higher than 2000m(6500ft).</li> <li>For any application note and IP water proof function installation caution, please refer our user manual before using. <a href="https://www.meanwell.com/Upload/PDF/LED_EN.pdf">https://www.meanwell.com/Upload/PDF/LED_EN.pdf</a></li> <li>For A/AB type need to consider build in using to comply with Type HL application.</li> <li>Products sourced from the Americas regions may only have the UL, CE and UKCA logos. Please contact your MEAN WELL sales for more information.</li> </ol> |  |               |               |               |             |             |             |             |              |  |
| <p>※ Product Liability Disclaimer : For detailed information, please refer to <a href="https://www.meanwell.com/serviceDisclaimer.aspx">https://www.meanwell.com/serviceDisclaimer.aspx</a></p> <p style="text-align: right;">File Name:HLG-185H-SPEC 2026-02-04</p> |   |  |               |               |               |             |             |             |             |              |  |

## ■ BLOCK DIAGRAM

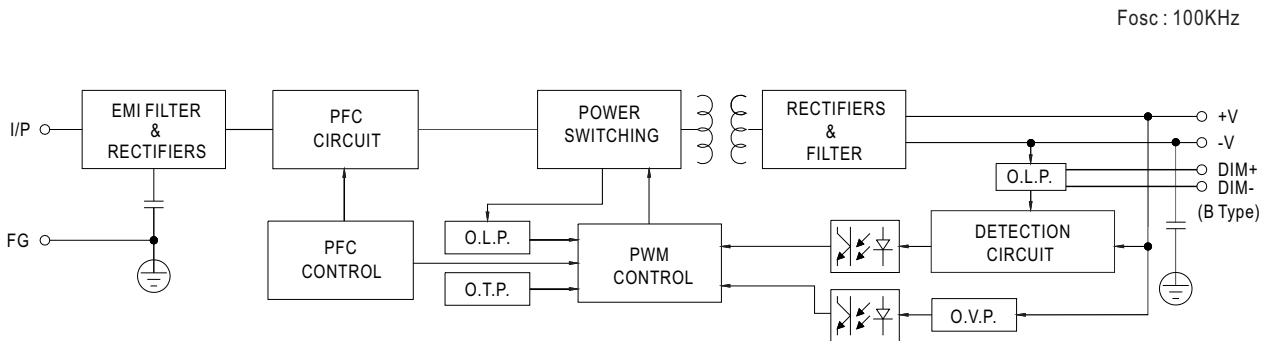

## ■ DRIVING METHODS OF LED MODULE

※ This series is able to work in either Constant Current mode (a direct drive way) or Constant Voltage mode (usually through additional DC/DC driver) to drive the LEDs.

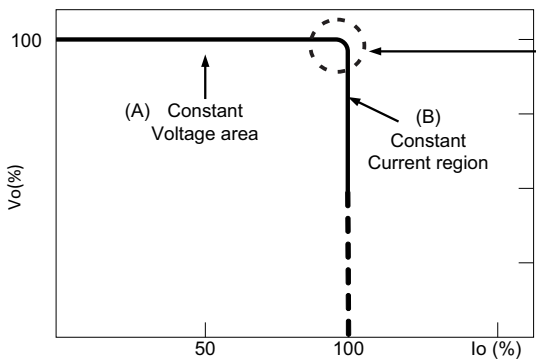

Typical output current normalized by rated current (%)

In the constant current region, the highest voltage at the output of the driver depends on the configuration of the end systems.

Should there be any compatibility issues, please contact MEAN WELL.

## DIMMING OPERATION

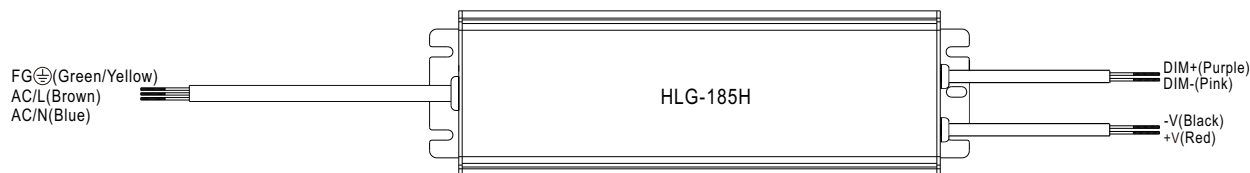

### ※ 3 in 1 dimming function (for B/AB-Type)

- Output constant current level can be adjusted by applying one of the three methodologies between DIM+ and DIM-: 1 ~ 10VDC, or 10V PWM signal or resistance.
- Direct connecting to LEDs is suggested. It is not suitable to be used with additional drivers.
- Dimming source current from power supply: 100 $\mu$ A (typ.)

#### ◎ Applying additive 1 ~ 10VDC

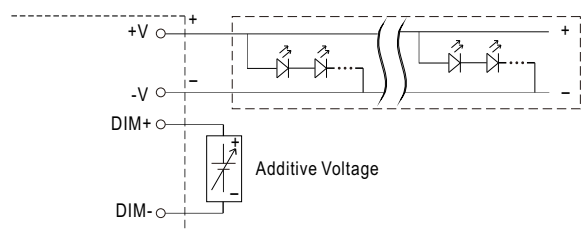

"DO NOT connect "DIM- to -V"

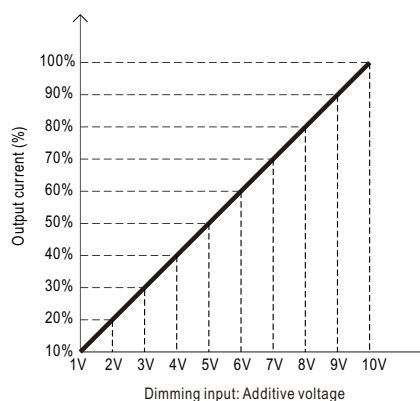

#### ◎ Applying additive 10V PWM signal (frequency range 100Hz ~ 3KHz):

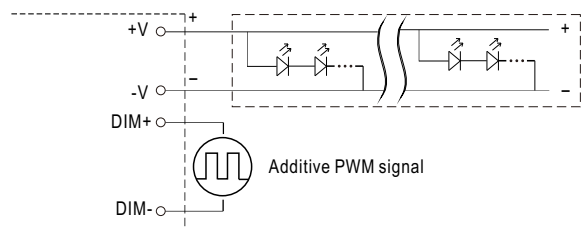

"DO NOT connect "DIM- to -V"

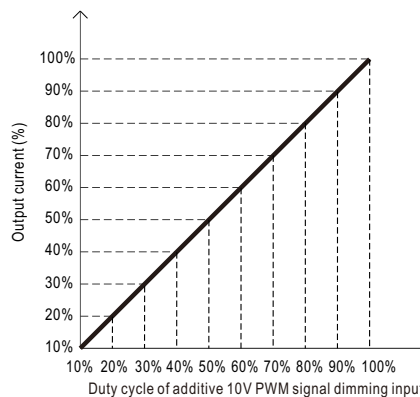

#### ◎ Applying additive resistance:

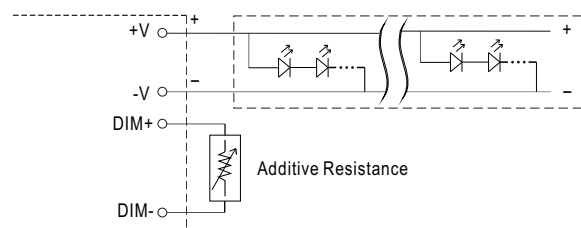

"DO NOT connect "DIM- to -V"

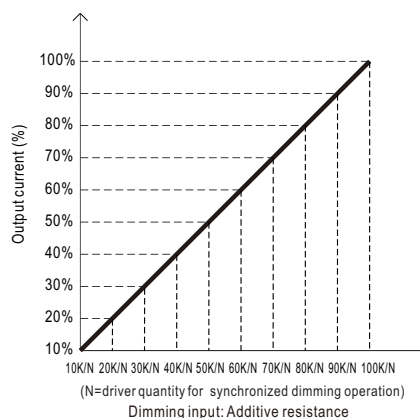

Note: In the case of turning the lighting fixture down to 0% brightness, please refer to the configuration as follow, or please contact MEAN WELL for other options.

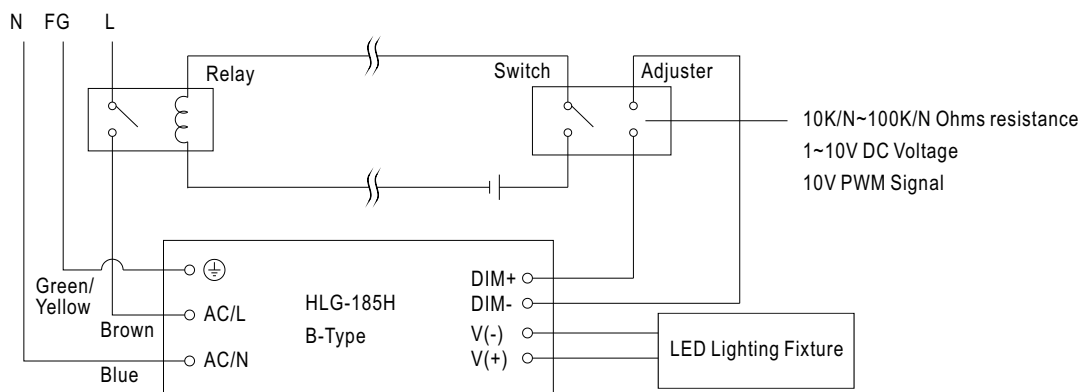

Using a switch and relay can turn ON/OFF the lighting fixture.

### OUTPUT LOAD vs TEMPERATURE( Note.10)

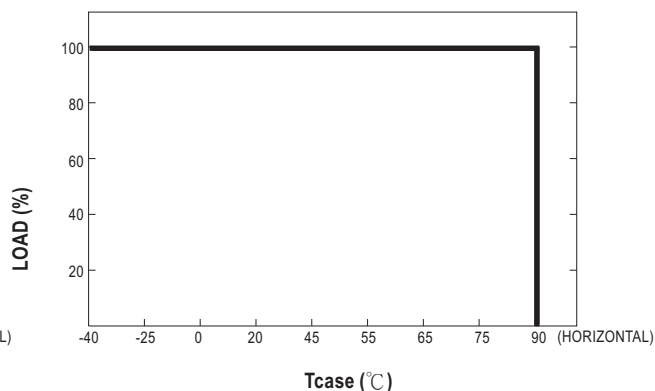
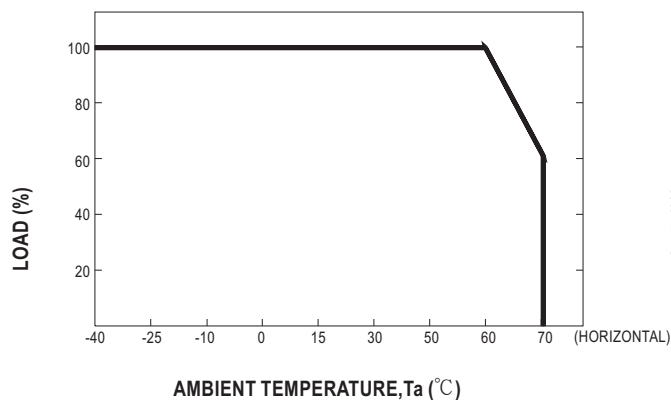

### STATIC CHARACTERISTICS

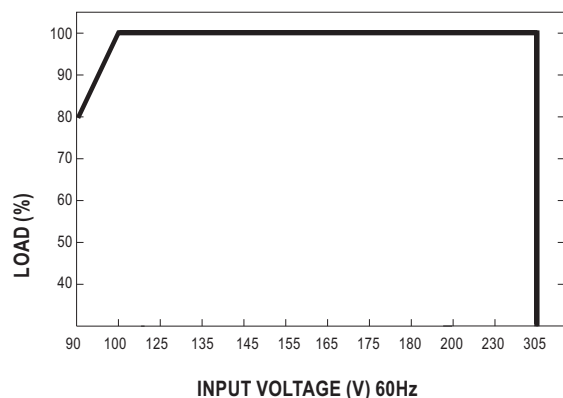

### POWER FACTOR(PF) CHARACTERISTIC

※ Tcase at 80°C

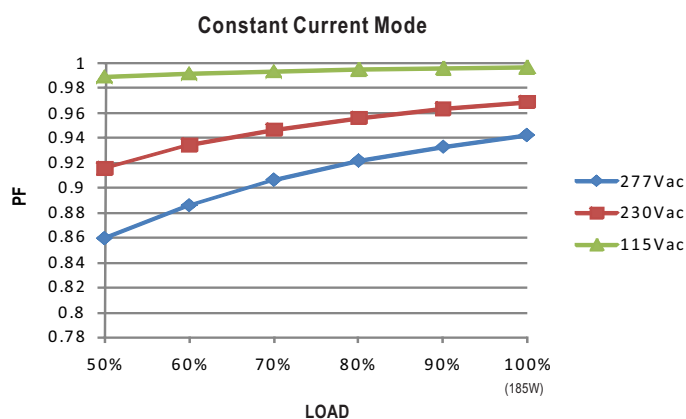

※ De-rating is needed under low input voltage.

### TOTAL HARMONIC DISTORTION (THD)

※ 48V Model, Tcase at 80°C

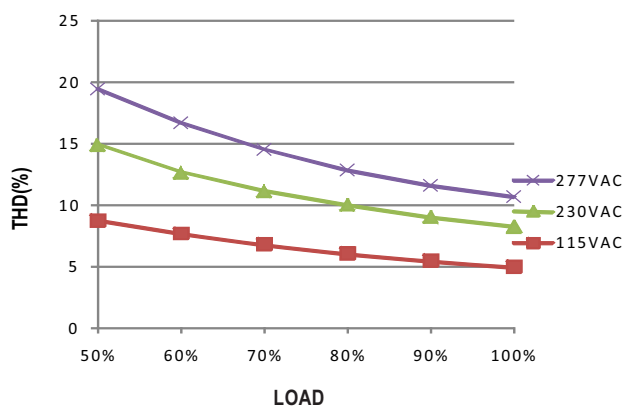

### EFFICIENCY vs LOAD

HLG-185H series possess superior working efficiency that up to 94% can be reached in field applications.

※ 48V Model, Tcase at 80°C

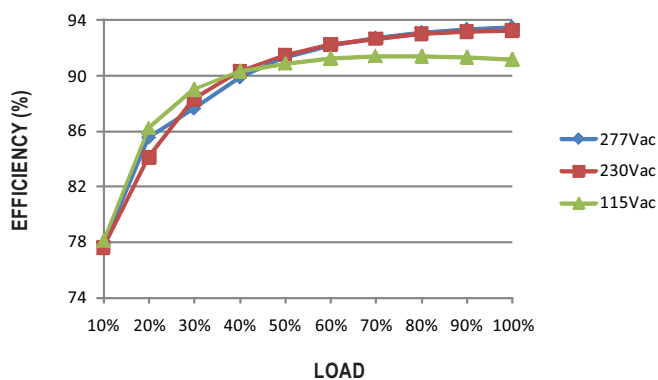



■ LIFE TIME

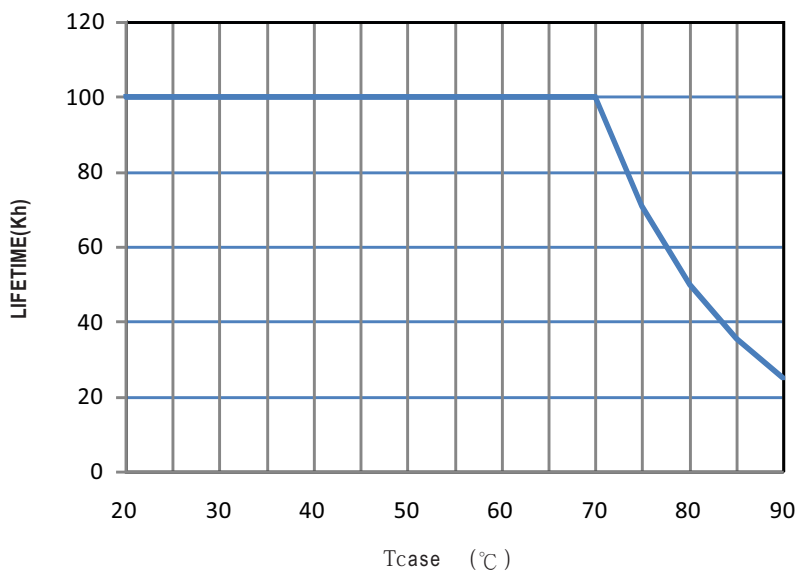

**MECHANICAL SPECIFICATION**

Case No.954D Unit:mm Tolerance:±1

※Blank/D-Type

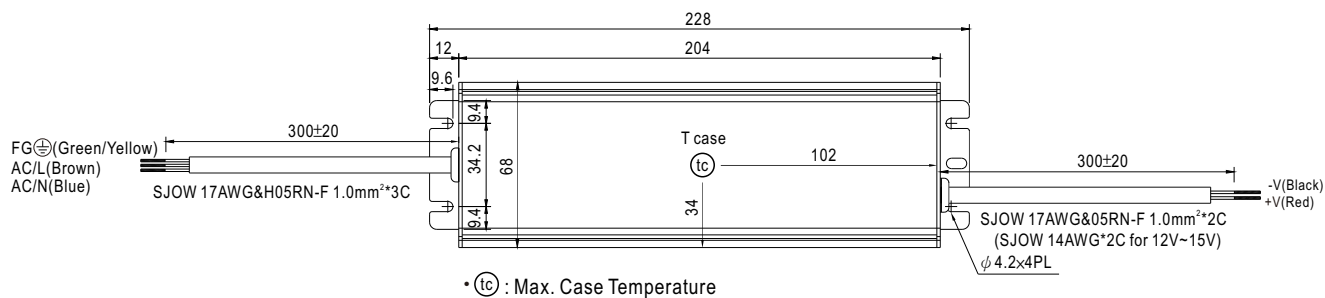

※A-Type

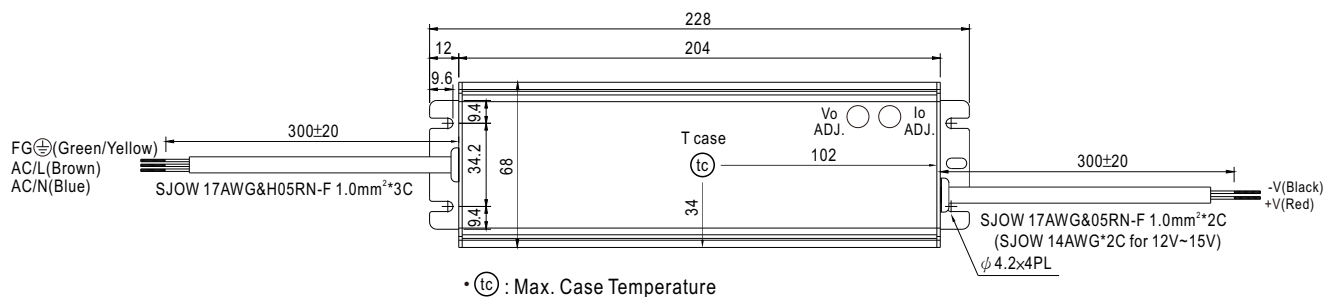

※B-Type

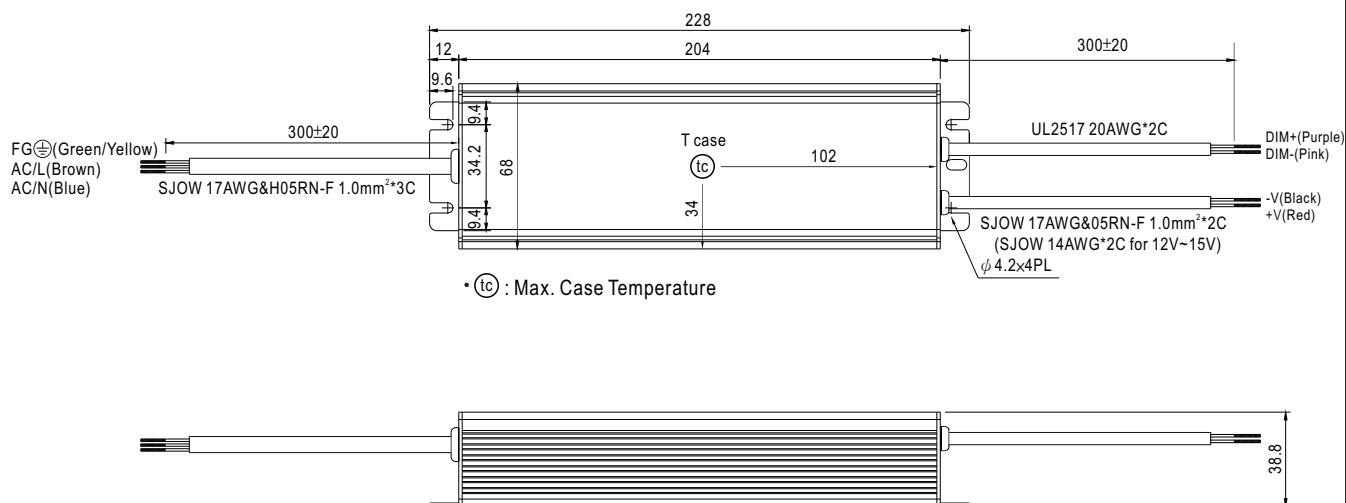

※AB-Type

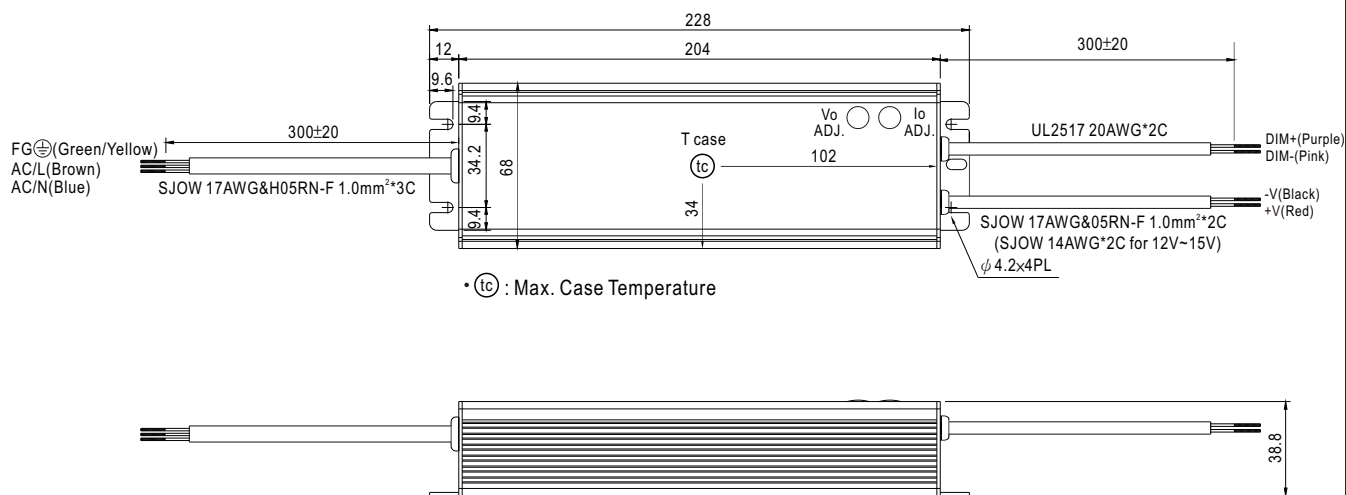

## ■ WATERPROOF CONNECTION

### ※ Waterproof connector

Waterproof connector can be assembled on the output cable of HLG-185H to operate in dry/wet/damp or outdoor environment.

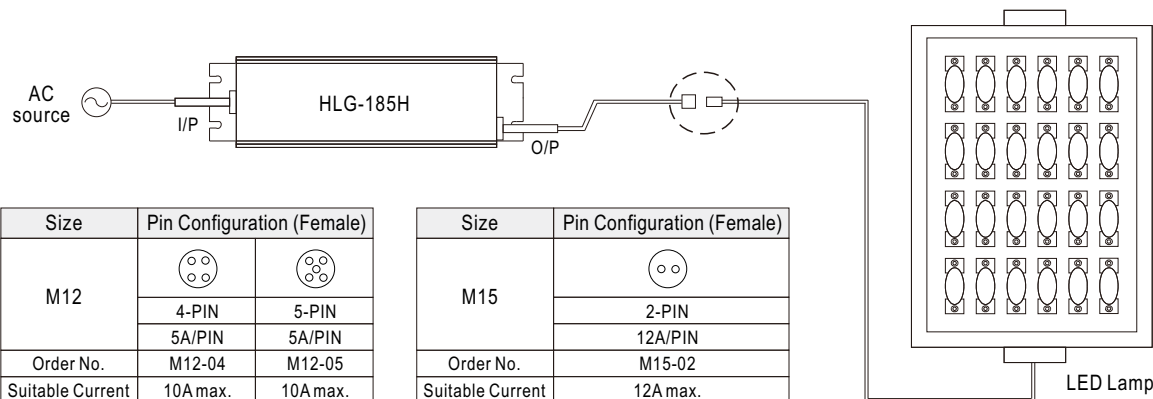

### ※ Cable Joiner

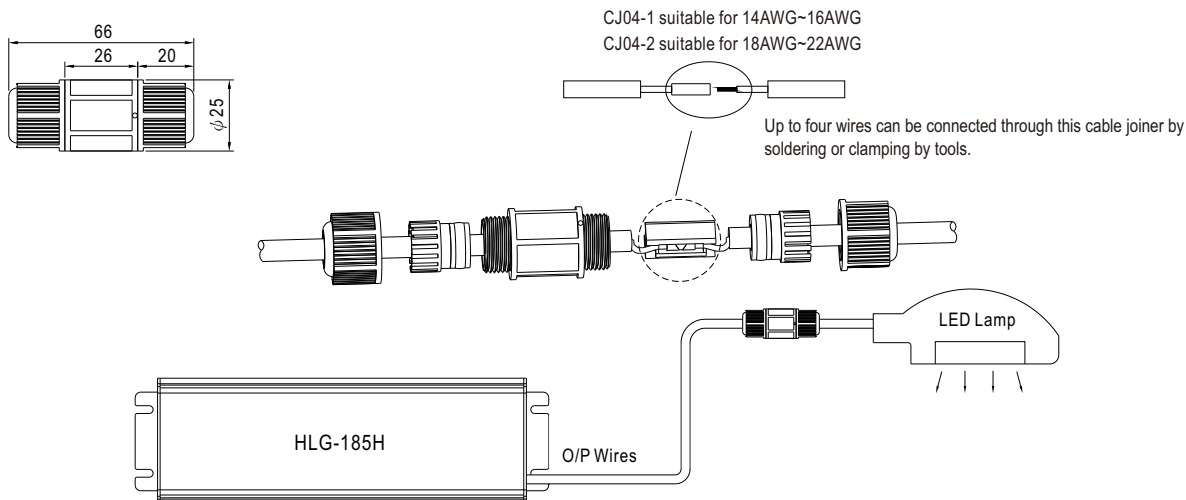

◎ CJ04 cable joiner can be purchased independently for user's own assembly.  
MEAN WELL order No. : CJ04-1, CJ04-2.

### ※ Junction Box Option

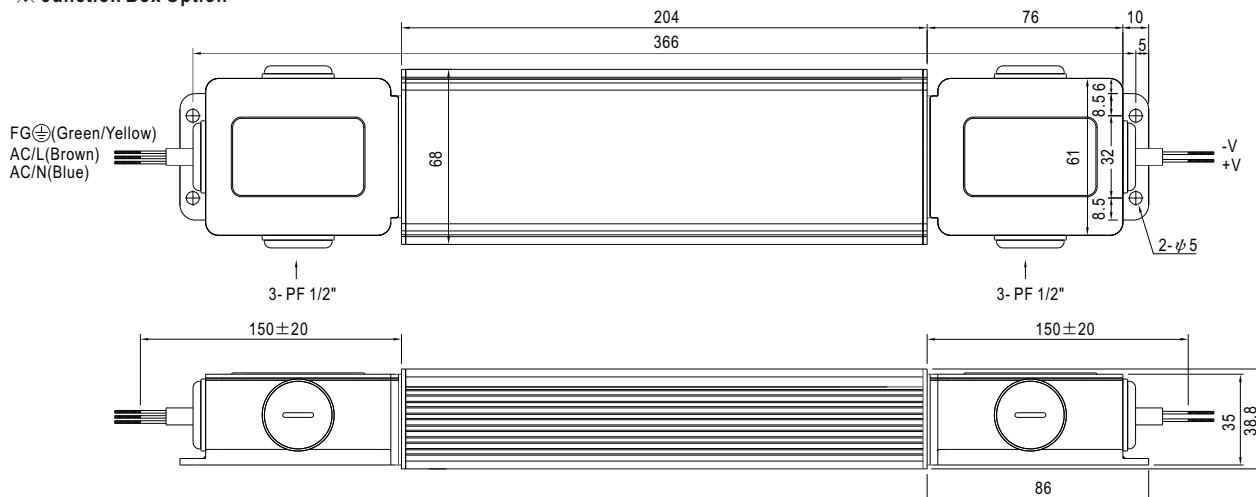

◎ Junction box option is available for A / Blank - Type. Please contact MEAN WELL for details.

## ■ INSTALLATION MANUAL

Please refer to : <http://www.meanwell.com/manual.html>