

REV	MARK	修改摘要	签名	日期
NO		REVISION DESCRIPTION	SIGNATURE	DATE
		NEW DWG		2016-03-12

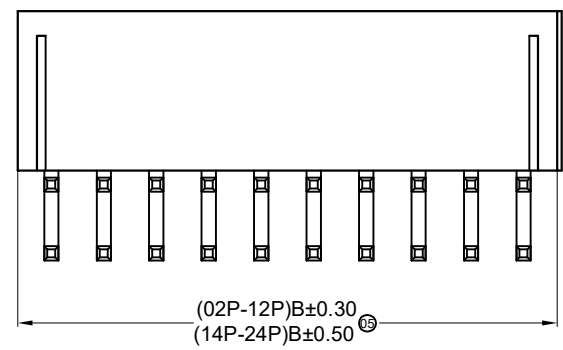

Specifications :

- Voltage rating: 600V AC / DC
- Current rating: 9A AC / DC
- Withstanding voltage: 1500V AC/minute
- Temperature range: -25°C~+85°C
- Insulation resistance: ≥100MΩ
- Contact resistance: ≤10mΩ
- After environmental testing: ≤20mΩ

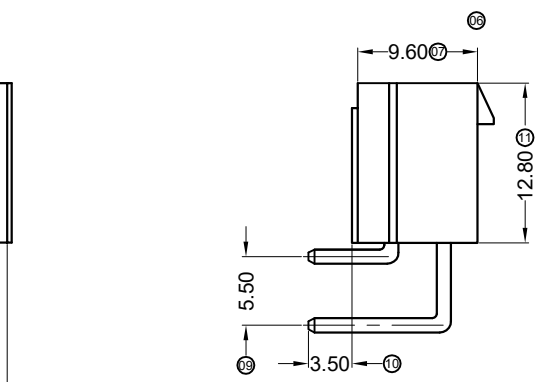
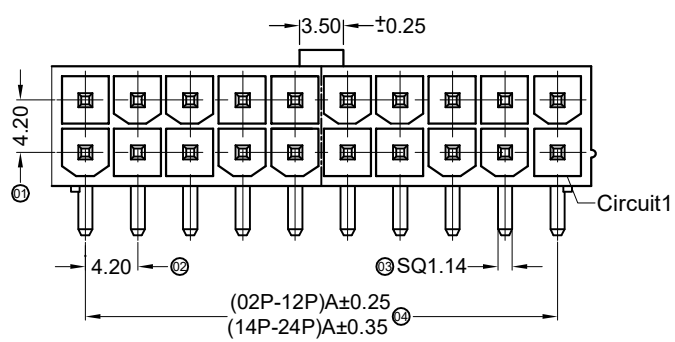
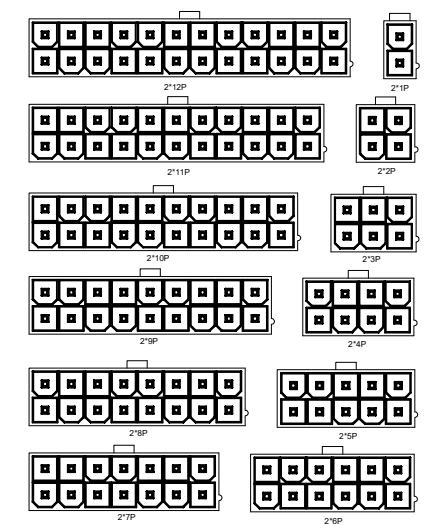

Contact	Dimensions	
	A	B
01	—	5.40
02	4.20	9.60
03	8.40	13.80
04	12.60	18.00
05	16.80	22.20
06	21.00	26.40
07	25.20	30.60
08	29.40	34.80
09	33.60	39.00
10	37.80	43.20
11	42.00	47.40
12	46.20	51.60
13	50.40	55.80
14	54.60	60.00

HDGC4201WR-F-2xXP	Nylon 66 UL 94V-2	Brass	Tin-Plated	4201H
PART NO	Material	Material(Pin)	Finish(Pin)	Mates With ZLT Housing

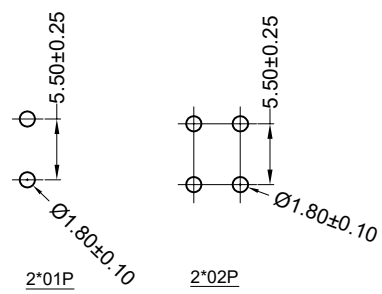

P.C.B LAYOUT

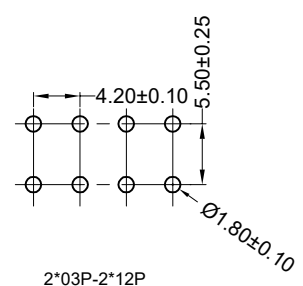

P.C.B LAYOUT



深圳市华德共创科技有限公司
Shenzhen Huade co-create Technology Co.,LTD
电话: 0755-27111216 传真: 0755-29940187

-TOLERANCES- UNLESS OTHERWISE SPECIFIED 公差参数表		TITLE: 产品名称: MX4.2无柱弯针	
X.X ±0.30	X.X* ±3°	APPD: 核准:	PART NO: 产品编号: 5557-2xXPWR(HDGC4201WR-2xXP)
X.XX ±0.20	X.XX* ±2°	CHECK: 校对: 王建业	DATE
X.XXX ±0.10	X.XXX* ±1°	DRAW: 绘图: 黄艳兰	SCALE
			UNIT
			CODE NUMBER
		2016-03-12	1:1
			mm
			A001

由 Autodesk 教育版产品制作

由 Autodesk 教育版产品制作