

Features

- * 330W peak pulse power (8/20 μ s)
- * Low operating :15V
- * Ultra low capacitance: 1.0 pF typical
- * Ultra low leakage: nA level
- * Low clamping voltage
- * Protects one power line or data line
- * Complies with following standards:
 - IEC 61000-4-2 (ESD) immunity test
Air discharge: ± 30 kV
Contact discharge: ± 30 kV
 - IEC61000-4-4 (EFT) 40A (5/50ns)
- * RoHS Compliant

Mechanical Characteristics

- * Package: SOD-323
- * Ultra low leakage: nA level
- * Case Material: “Green” Molding Compound.
- * UL Flammability Classification Rating 94V-0
- * Moisture Sensitivity: Level 3 per J-STD-020
- * Shipping Qty :3000pcs/7Inch Tape & Reel

Applications

- * Cellular Handsets and Accessories
- * Personal Digital Assistants
- * Notebooks and Handhelds
- * Portable Instrumentation
- * Peripherals

Dimensions and Pin Configuration

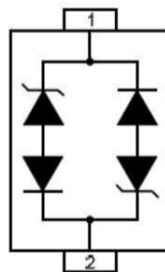

Marking: EC

Absolute Maximum Ratings (Tamb=25°C unless otherwise specified)

Parameter	Symbol	Value	Unit
ESD per IEC 61000-4-2 (Air)	VESD	±30	kV
ESD per IEC 61000-4-2 (Contact)		±30	
Operating Temperature Range	TJ	-55 to +125	°C
Storage Temperature Range	Tstg	-55 to +150	°C

Electrical Characteristics (TA=25°C unless otherwise specified)

Symbol	Parameter
V _{RWM}	Nominal Reverse Working Voltage
I _R	Reverse Leakage Current @ V _{RWM}
V _{BR}	Reverse Breakdown Voltage @ I _T
I _T	Test Current for Reverse Breakdown
V _C	Clamping Voltage @ I _{PP}
I _{PP}	Maximum Peak Pulse Current
C _{ESD}	Parasitic Capacitance
V _R	Reverse Voltage
f	Small Signal Frequency

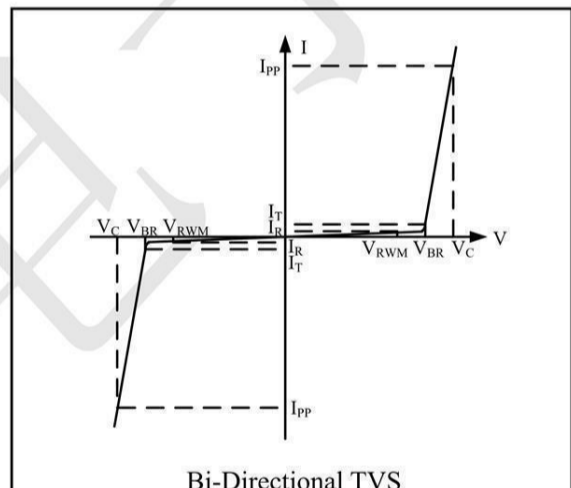

Parameter	Symbol	Test Condition	Min	Typ	Max	Unit
Reverse Working Voltage	V _{RWM}				15	V
Breakdown Voltage	V _{BR}	I _T = 1mA	16			V
Reverse Leakage Current	I _R	V _{RWM} = 15V			0.2	μA
Clamping Voltage	V _C	I _{PP} = 1A (8 x 20μs pulse)			22	V
Clamping Voltage	V _C	I _{PP} = 10A (8 x 20μs pulse)			31	V
Junction Capacitance	C _J	V _R = 0V, f = 1MHz		1		pF

Electrical Characteristics ($T_A=25^\circ\text{C}$ unless otherwise specified)

Fig1. 8/20 μs Pulse Waveform

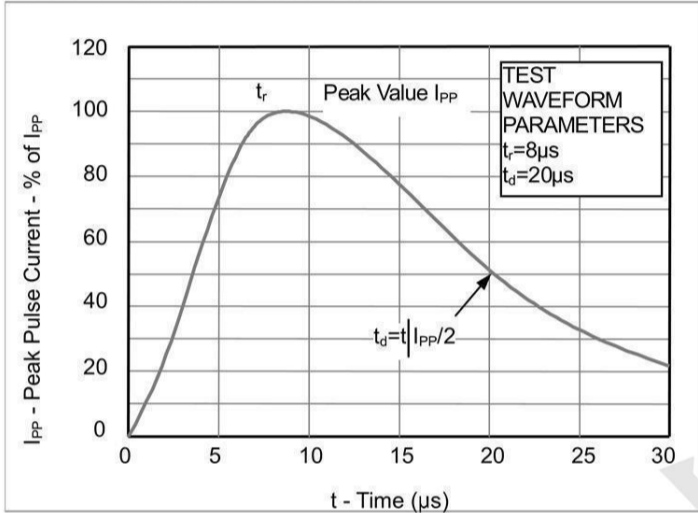

Fig2. ESD Pulse Waveform (according to IEC 61000-4-2)

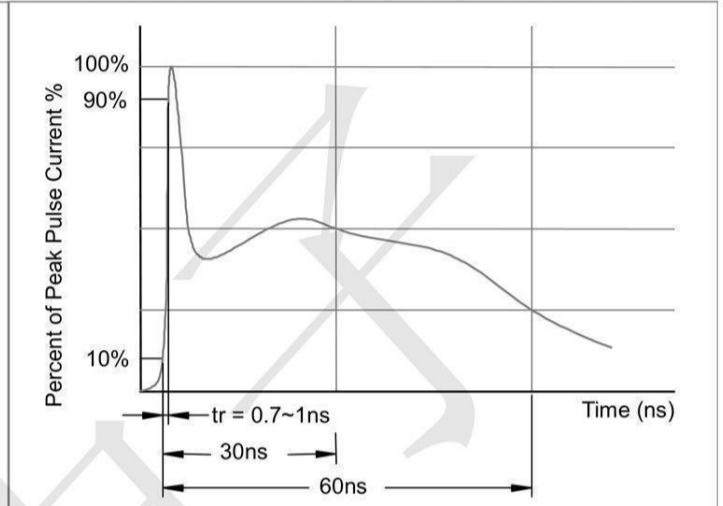
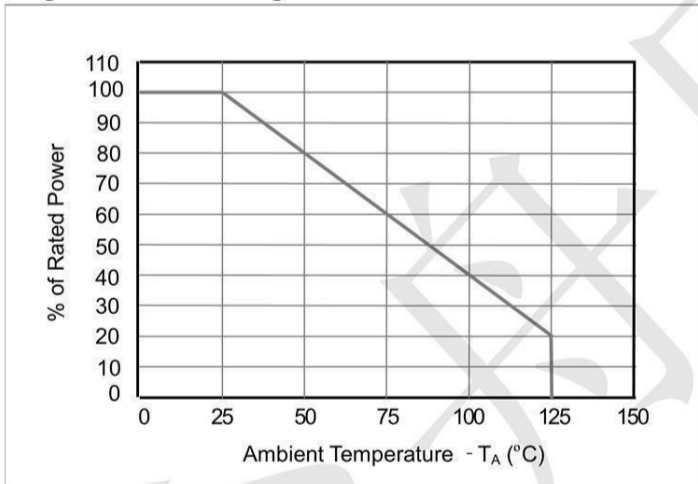
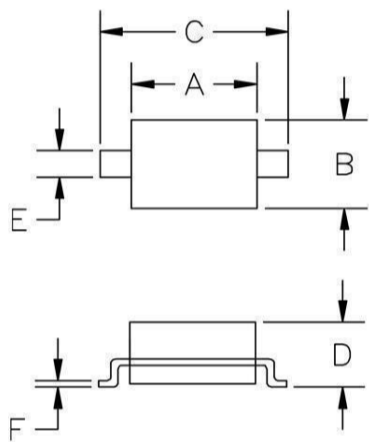

Fig3. Power Derating Curve



Outline Drawing - SOD-323



SYM	DIMENSIONS			
	MILLIMETERS		INCHES	
	MIN	MAX	MIN	MAX
A	1.50	1.80	0.060	0.071
B	1.20	1.40	0.045	0.054
C	2.30	2.70	0.090	0.107
D	-	1.10	-	0.043
E	0.30	0.40	0.012	0.016
F	0.10	0.25	0.004	0.010
H	-	0.10	-	0.004

Land Pattern - SOD-323

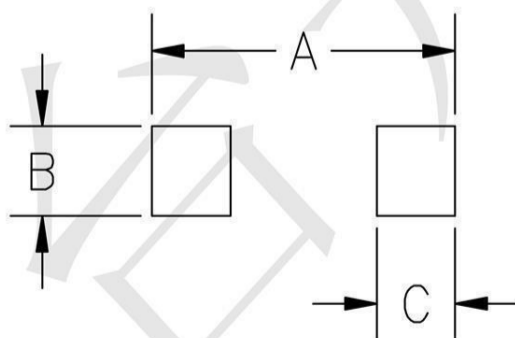

SYM	DIMENSIONS	
	MILLIMETERS	INCHES
A	3.15	0.120
B	0.80	0.031
C	0.80	0.031