

General Description

CMF80R450P is power MOSFET using CMOS's advanced super junction technology that can realize very low on-resistance and gate charge. It will provide much high efficiency by using optimized charge coupling technology.

Features

- Multi-layer Epitaxial Chip Technology
- Low On-Resistance
- 100% Avalanche Tested
- RoHS Compliant

Product Summary

BVDSS	R _{DS(on)} max.	ID
800V	0.4Ω	11A

Applications

- Adaptor
- Motor Control
- DC – DC Converters
- PFC Power Supply Stages
- Switching Applications

TO-220F Pin Configuration

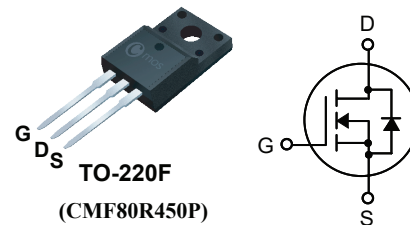

Absolute Maximum Ratings (T_c=25°C unless otherwise noted)

Symbol	Parameter	Rating	Units
V _{DSS}	Drain-Source Voltage	800	V
I _D	Drain Current - Continuous (T _C = 25°C) - Continuous (T _C = 100°C)	11	A
		7	A
I _{DM}	Drain Current - Pulsed	33	A
V _{GSS}	Gate-Source Voltage	±30	V
E _{AS}	Single Pulsed Avalanche Energy	260	mJ
P _D	Power Dissipation (T _C = 25°C)	35	W
T _J , T _{STG}	Operating and Storage Temperature Range	-55 to +150	°C

Thermal Characteristics

Symbol	Parameter	Rating	Units
R _{θJC}	Thermal Resistance, Junction-to-Case	3.57	°C/W
R _{θJA}	Thermal Resistance, Junction-to-Ambient	62.5	°C/W

Electrical Characteristic (Tc=25°C unless otherwise noted)

Symbol	Parameter	Test Conditions	Min	Typ	Max	Units
--------	-----------	-----------------	-----	-----	-----	-------

Off Characteristics

BV _{DSS}	Drain-Source Breakdown Voltage	V _{GS} = 0 V, I _D = 250 μA	800	--	--	V
I _{DSS}	Zero Gate Voltage Drain Current	V _{DS} = 800 V, V _{GS} = 0 V	--	--	1	μA
I _{GSSF}	Gate-Body Leakage Current, Forward	V _{GS} = 30 V, V _{DS} = 0 V	--	--	100	nA
I _{GSSR}	Gate-Body Leakage Current, Reverse	V _{GS} = -30 V, V _{DS} = 0 V	--	--	-100	nA

On Characteristics

V _{GS(th)}	Gate Threshold Voltage	V _{DS} = V _{GS} , I _D = 250 μA	2	--	4	V
R _{DS(on)}	Static Drain-Source on-Resistance	V _{GS} = 10 V, I _D = 7A	--	0.3	0.4	Ω
g _{FS}	Forward Transconductance	V _{DS} = 15V, I _D = 4A	--	9	--	S
R _g	Gate Resistance	V _{DS} =0V, V _{GS} =0V, f=1MHz	--	2.1	--	Ω

Dynamic Characteristics

C _{iss}	Input Capacitance	V _{DS} = 100V, V _{GS} = 0 V f = 1.0 MHz	--	1280	--	pF
C _{oss}	Output Capacitance		--	48	--	pF
C _{rss}	Reverse Transfer Capacitance		--	3	--	pF

Switching Characteristics

t _{d(on)}	Turn-On Delay Time	V _{DS} = 400 V, I _D = 11A R _G = 25 Ω, V _{GS} = 10V	--	25	--	ns
t _r	Turn-On Rise Time		--	45	--	ns
t _{d(off)}	Turn-Off Delay Time		--	120	--	ns
t _f	Turn-Off Fall Time		--	45	--	ns
Q _g	Total Gate Charge	V _{DS} = 640 V, I _D = 11A V _{GS} = 10 V	--	38	--	nC
Q _{gs}	Gate-Source Charge		--	7.5	--	nC
Q _{gd}	Gate-Drain Charge		--	16	--	nC

Drain-Source Diode Characteristics and Maximum Ratings

I _S	Maximum Continuous Drain-Source Diode Forward Current	--	--	11	A	
I _{SM}	Maximum Pulsed Drain-Source Diode Forward Current	--	--	33	A	
V _{SD}	Drain-Source Diode Forward Voltage	V _{GS} = 0 V, I _S = 10A	--	--	1.4	V
t _{rr}	Reverse Recovery Time	V _{DD} = 100V, I _F = 11A	--	356	--	ns
Q _{rr}	Reverse Recovery Charge	dI _F / dt = 100 A/μs	--	4.7	--	μC

This product has been designed and qualified for the consumer market.

Cmos assumes no liability for customers' product design or applications.

Cmos reserves the right to improve product design, functions and reliability without notice. Please refer to the latest version of specification.

Typical Characteristics

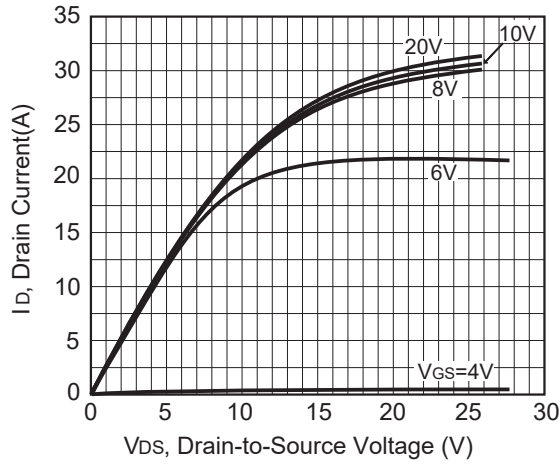

Output Characteristics

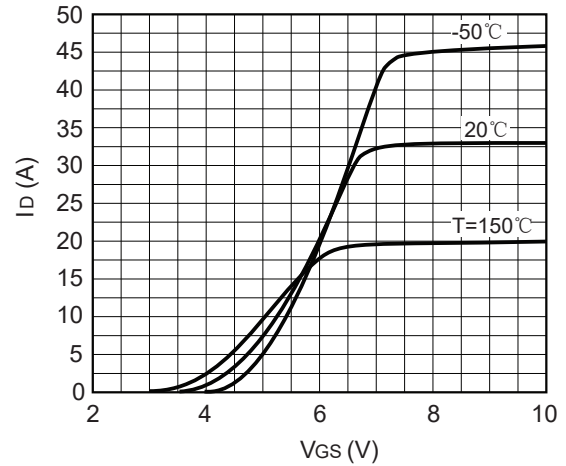

Transfer Characteristics

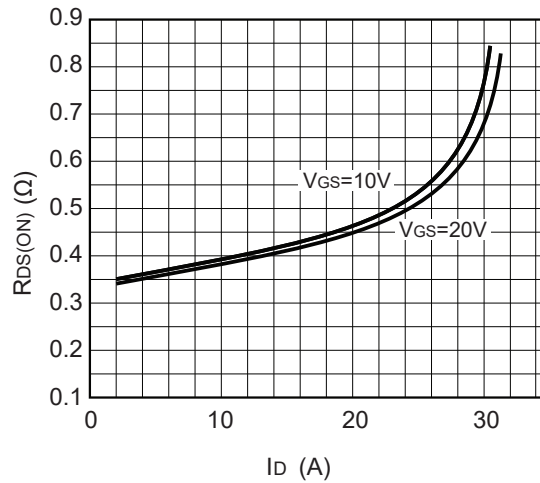

On-Resistance Variation with Drain Current and Gate Voltage

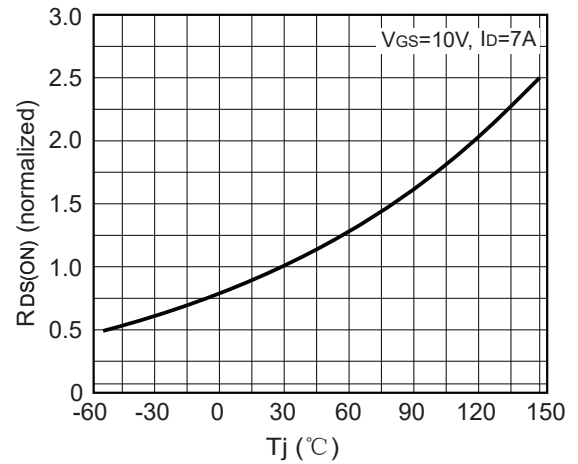

On-Resistance Variation with Temperature

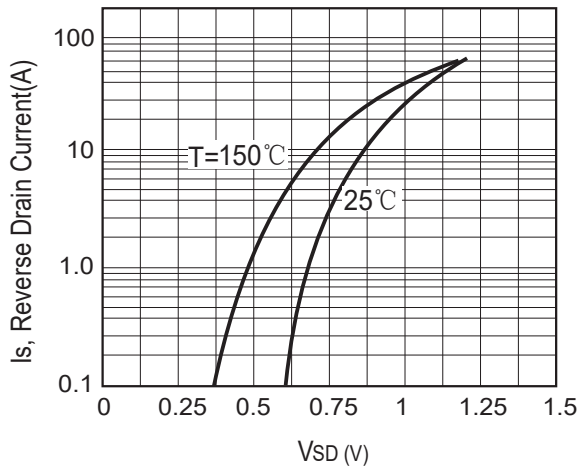

Body Diode Forward Voltage Variation with Source Current and Temperature

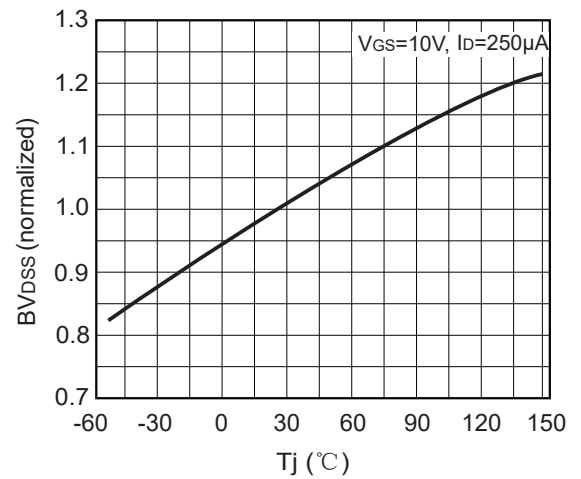

Breakdown Voltage Variation vs Temperature

Typical Characteristics

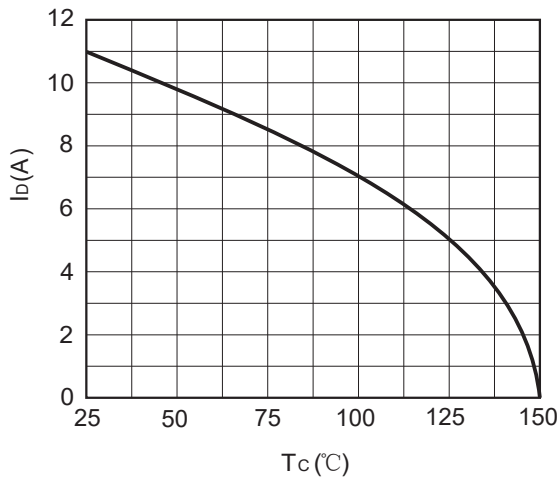

Maximum Drain Current vs. Case Temperature

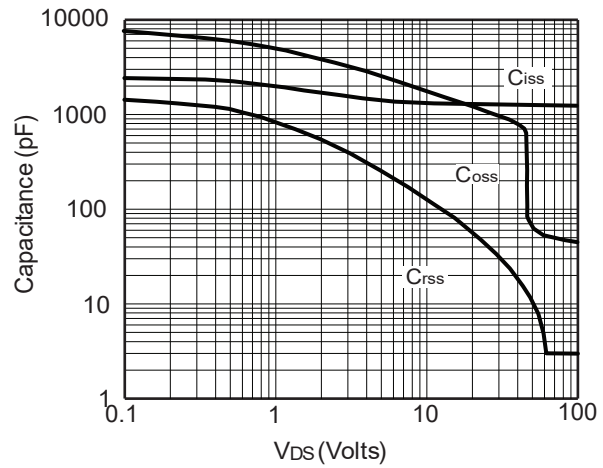

Capacitance Characteristics

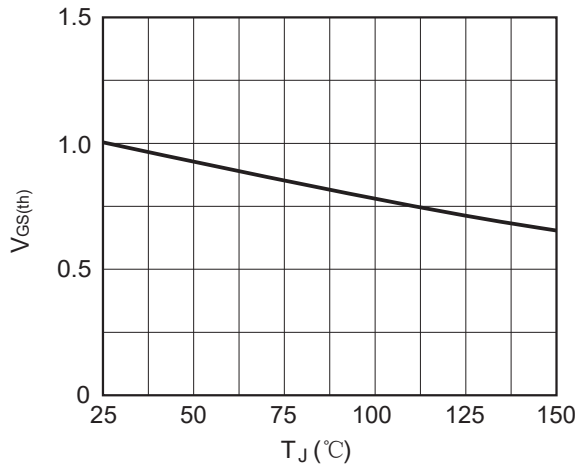

$V_{GS(th)}$ Variation with Temperature

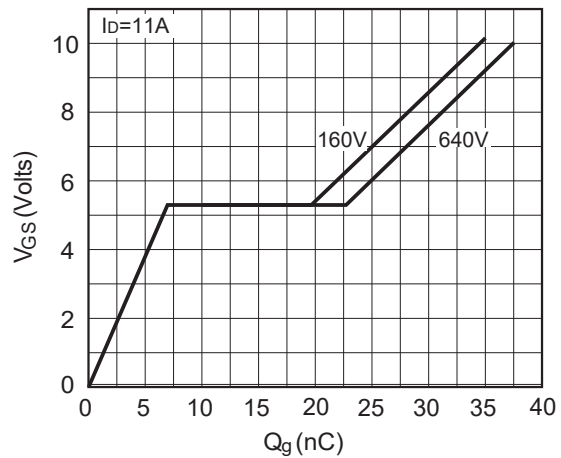

Gate-Charge Characteristics

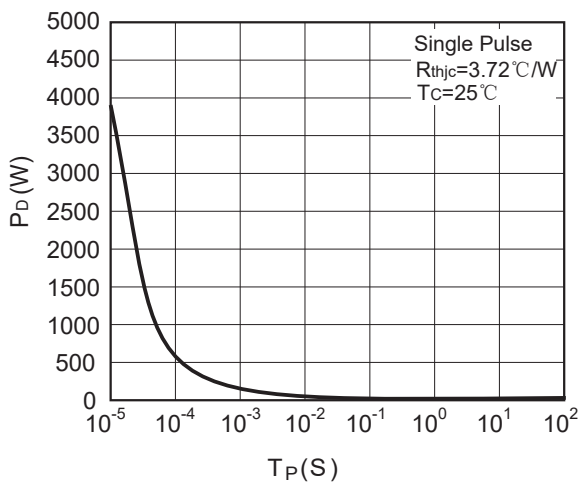

Transient Thermal Response Curve

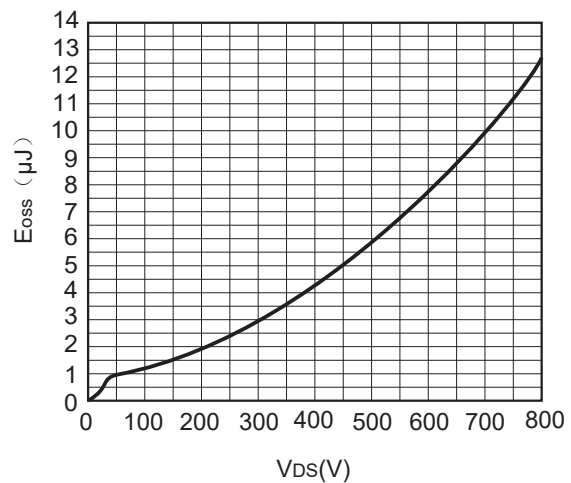

Output Capacitance Stored Energy

Typical Characteristics

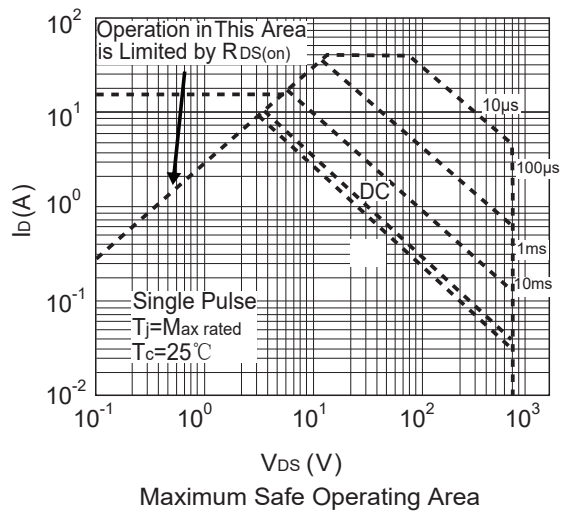
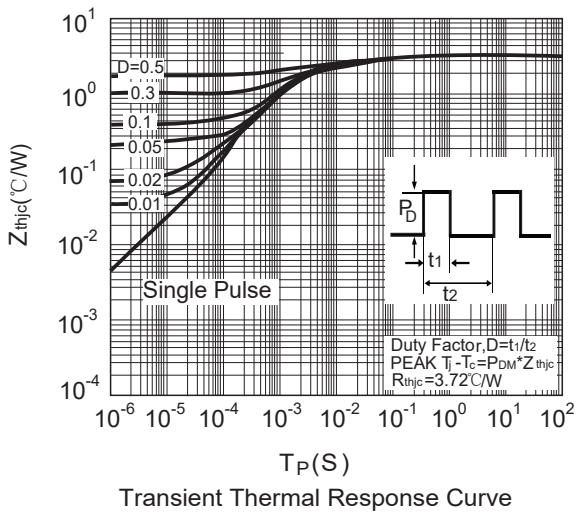

Package Dimensions

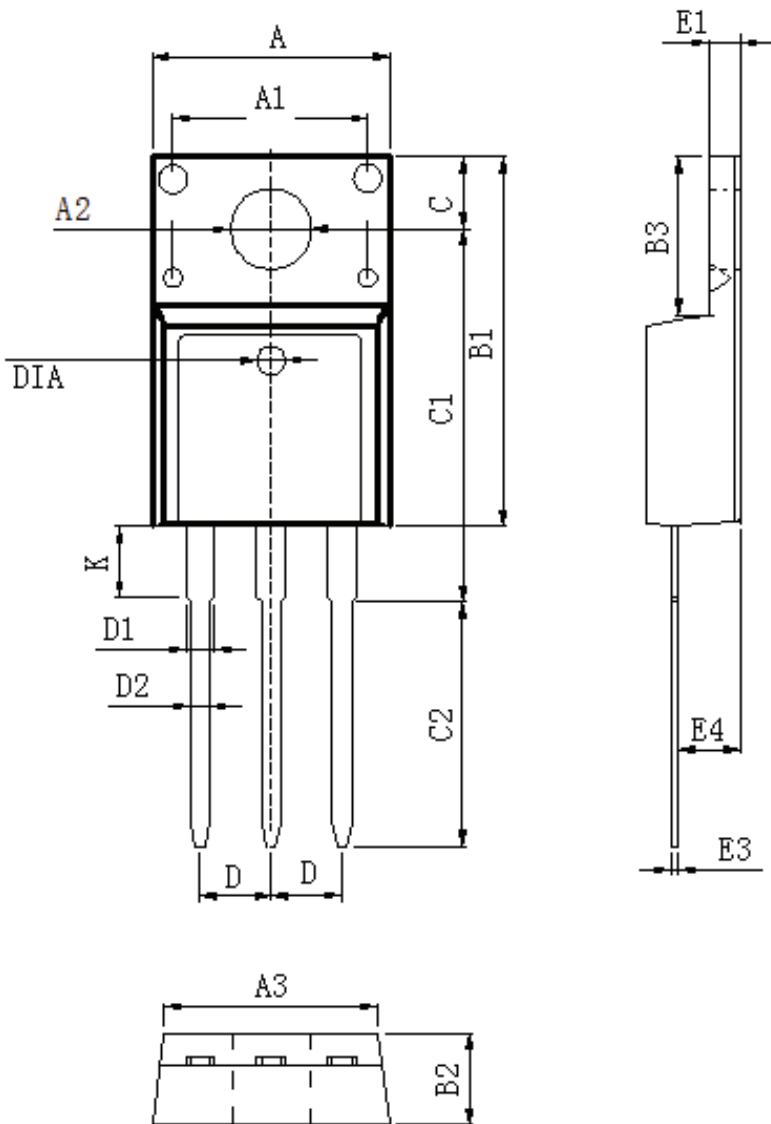

DIM	MILLIMETERS
A	10.16±0.3
A1	7.00±0.1
A2	3.3±0.2
A3	9.5±0.2
B1	15.87±0.3
B2	4.7±0.2
B3	6.68±0.4
C	3.3±0.2
C1	12.57±0.3
C2	10.02±0.5
D	2.54±0.05
D1	1.28±0.2
D2	0.8±0.1
K	3.1±0.3
E1	2.54±0.1
E3	0.5±0.1
E4	2.76±0.2
DIA	⊙1.5 (deep 0.2)

Unit :mm

Dimensions in Millimeters