



RECOMMENDED PCB LAYOUT
TOLERANCE: ±0.05
TOP VIEW

MATERIALS

1. HOUSING : LCP, BLACK.
2. TERMINAL : COPPER ALLOY (T=0.20mm)
PLATING: SELECTIVE GOLD OR Pd/Ni + GOLD PLATED ON CONTACT AREA, TIN PLATED ON SOLDER TAILS, NICKEL UNDER PLATED OVERALL
3. SHELL : STAINLESS STEEL (T=0.30mm)
PLATING: NICKEL PLATED OVERALL.
4. COVER: LCP, BLACK.
5. SPRING SHELL: STAINLESS STEEL (T=0.15mm).

SPECIFICATION

1. CURRENT RATING : 0.5A Min., 3.3V 3A FOR PIN#20(POWER PIN),
Refer to the attached material specification test conditions, the PIN#20 can meet 3A temperature rise is less than 30 degrees C.
2. CONTACT RESISTANCE : 30mΩ MAX.
3. DIELECTRIC WITHSTANDING VOLTAGE :
500V AC R.M.S. FOR ONE MINUTE.
4. INSULATION RESISTANCE : 100MΩ MIN AT 500V DC.
5. OPERATING TEMPERATURE : -25°C TO +85°C.
6. DURABILITY : 10000 CYCLES.
7. MATING FORCE : 4.5Kgf MAX.
8. UNMATING FORCE : 1.0Kgf~4.0Kgf.

 深圳市华宇创精密电子有限公司			
TOLERANCE: X.X ±0.30 X.XX ±0.25 X.XXX ±0.15 X' ±2' X.X' ±0.5'	DRAWN BY : 陈一鸣	DATE : 2014-02-23	PART NAME: MINI DP SMT式 带弹片母座(中心高3.8)
	CHECKED BY: 马跃	DATE : 2014-02-23	PART NO. HYCW30-MDP20-038B
  UNIT: mm [inch] SCALE:1:1 SIZE: A4	APPROVED BY: 邱敏	DATE : 2014-02-23	MOLD NO. _____ DRAW NO: HYC-2603301430
			SHEET NO. 1 OF 1

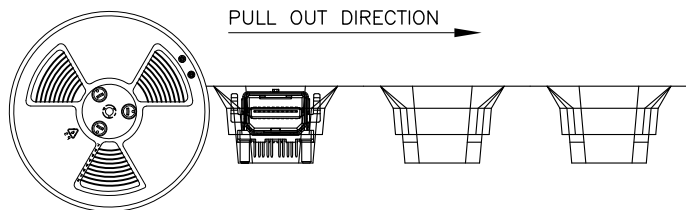
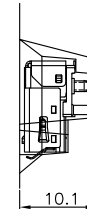
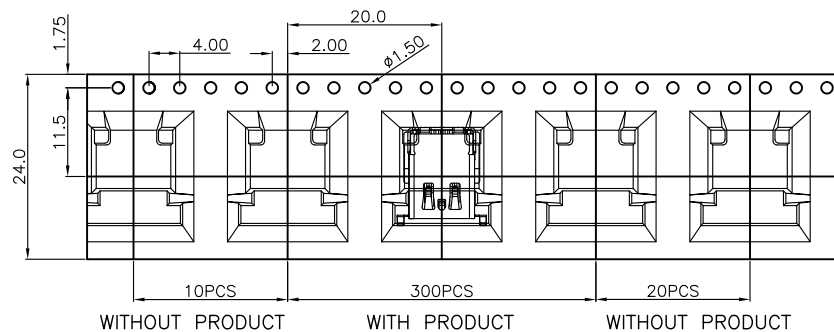

PACKAGE

1. SIZE :
 REEL : DIA.=330mm
 CORTON : 350x350x340mm (LxWxH)
2. QUANTITY :
 300 PCS/REEL
 11 REEL/CARTON = 3300PCS

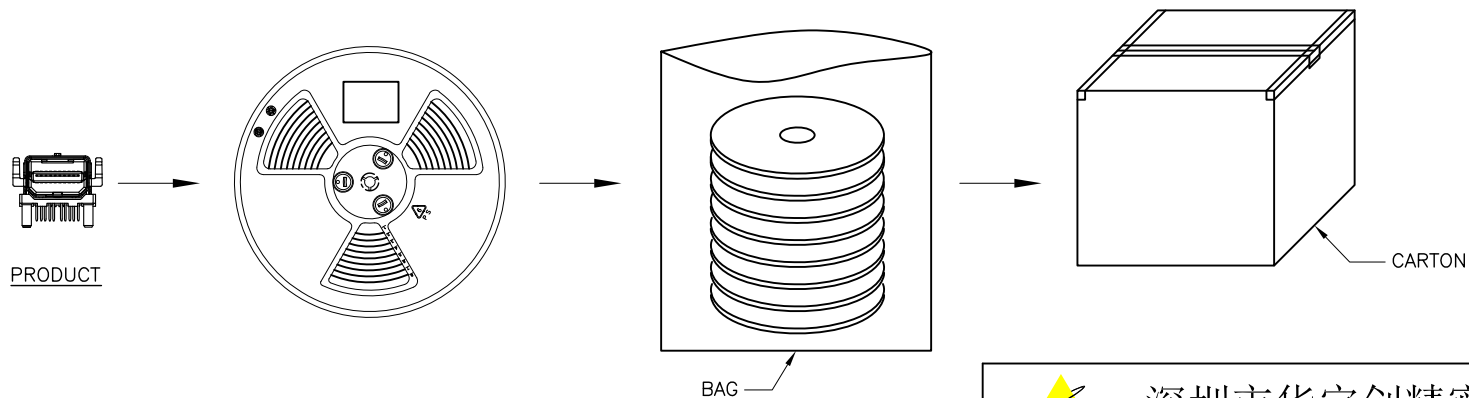

 深圳市华宇创精密电子有限公司			
TOLERANCE: X.X ±0.30 X.XX ±0.25 X.XXX ±0.15 X' ±2' X.X' ±0.5'	DRAWN BY : 陈一鸣	DATE : 2014-02-23	PART NAME: 包装图
	CHECKED BY: 马跃	DATE : 2014-02-23	PART NO. MOLD NO.
UNIT: mm [inch] SCALE:1:1 SIZE: A4	APPROVED BY: 邱敏	DATE : 2014-02-23	DRAW NO: SHEET NO. 1 OF 1