

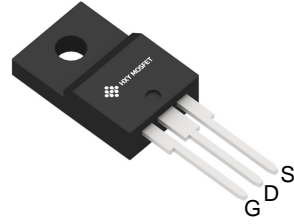

Description

The STF13NM50N can be used in various power switching circuit for system miniaturization and higher efficiency. The package form is TO-220F, which accords with the RoHS standard.



TO-220F

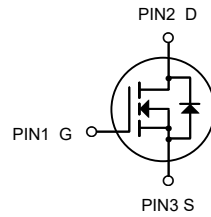

N-Channel MOSFET

General Features

$V_{DS} = 500V, I_D = 20A$
 $R_{DS(ON)} < 0.3\Omega @ V_{GS}=10V$

Application

- Power switch circuit of adaptor and charger.

Ordering Information

Product ID	Pack	Brand	Units Tube
STF13NM50N	TO-220F	HXYMOSFET	50

Absolute Maximum Ratings@T=25°C(unless otherwise specified)

Symbol	Parameter	Limit	Unit
V_{DSS}	Drain-to-Source Voltage ^[1]	500	V
V_{GSS}	Gate-to-Source Voltage	±30	
I_D	Continuous Drain Current	20	A
$I_D @ T_c=100^\circ C$	Continuous Drain Current @ $T_c=100^\circ C$	Figure 3	
I_{DM}	Pulsed Drain Current at $V_{GS}=10V$ ^[2]	Figure 6	
E_{AS}	Single Pulse Avalanche Energy	1500	mJ
dv/dt	Peak Diode Recovery dv/dt ^[3]	5.0	V/ns
P_D	Power Dissipation	165	W
T_L T_{PAK}	Maximum Temperature for Soldering Leads at 0.063in (1.6mm) from Case for 10 seconds, Package Body for 10 seconds	300 260	°C
T_J & T_{STG}	Operating and Storage Temperature Range	-55 to 150	
$R_{\theta JC}$	Thermal Resistance, Junction-to-Case	2.27	°C/W
$R_{\theta JA}$	Thermal Resistance, Junction-to-Ambient	100	

Caution: Stresses greater than those listed in the "Absolute Maximum Ratings" may cause permanent damage to the device.



Electrical Characteristics $T_J=25^\circ\text{C}$ unless otherwise specified

Symbol	Parameter	Min.	Typ.	Max.	Unit	Test Conditions
BV_{DSS}	Drain-to-Source Breakdown Voltage	500	--	--	V	$V_{GS}=0V, I_D=250\mu A$
I_{DSS}	Drain-to-Source Leakage Current	--	--	1	μA	$V_{DS}=500V, V_{GS}=0V$
		--	--	100		$V_{DS}=400V, V_{GS}=0V,$ $T_J=125^\circ C$
I_{GSS}	Gate-to-Source Leakage Current	--	--	+100	nA	$V_{GS}=+30V, V_{DS}=0V$
		--	--	-100		$V_{GS}=-30V, V_{DS}=0V$
$R_{DS(ON)}$	Static Drain-to-Source On-Resistance ^[4]	--	0.26	0.3	Ω	$V_{GS}=10V, I_D=10A$
$V_{GS(TH)}$	Gate Threshold Voltage	2.0	--	4.0	V	$V_{DS}=V_{GS}, I_D=250\mu A$
g_{fs}	Forward Transconductance ^[4]	--	17	--	S	$V_{DS}=15V, I_D=10A$
C_{iss}	Input Capacitance	--	2864	--	pF	$V_{GS}=0V,$ $V_{DS}=25V,$ $f=1.0MHz$
C_{rss}	Reverse Transfer Capacitance	--	25	--		
C_{oss}	Output Capacitance	--	286	--		
Q_g	Total Gate Charge	--	63	--	nC	$V_{DD}=250V,$ $I_D=20A, V_{GS}=0$ to $10V$
Q_{gs}	Gate-to-Source Charge	--	14	--		
Q_{gd}	Gate-to-Drain (Miller) Charge	--	24	--		
$t_{d(ON)}$	Turn-on Delay Time	--	33	--	nS	$V_{DD}=250V,$ $I_D=20A,$ $V_{GS}=10V$ $R_G=25\Omega$
t_{rise}	Rise Time	--	75	--		
$t_{d(OFF)}$	Turn-Off Delay Time	--	181	--		
t_{fall}	Fall Time	--	83	--		
I_{SD}	Continuous Source Current ^[4]	--	--	20	A	Integral PN-diode in MOSFET
I_{SM}	Pulsed Source Current ^[4]	--	--	80		
V_{SD}	Diode Forward Voltage	--	--	1.5	V	$I_S=20A, V_{GS}=0V$
t_{rr}	Reverse recovery time	--	392	--	V	$V_{GS}=0V, I_F=20A,$ $di_F/dt=100A/\mu s$
Q_{rr}	Reverse recovery charge	--	3.3	--	μC	

Note:

- [1] $T_J=+25^\circ C$ to $+150^\circ C$
- [2] Repetitive rating; pulse width limited by maximum junction temperature.
- [3] $I_{SD}=20A$ $di/dt < 100 A/\mu s, V_{DD} < BV_{DSS}, T_J=+150^\circ C.$
- [4] Pulse width $\leq 380\mu s$; duty cycle $\leq 2\%$.



Typical Characteristics

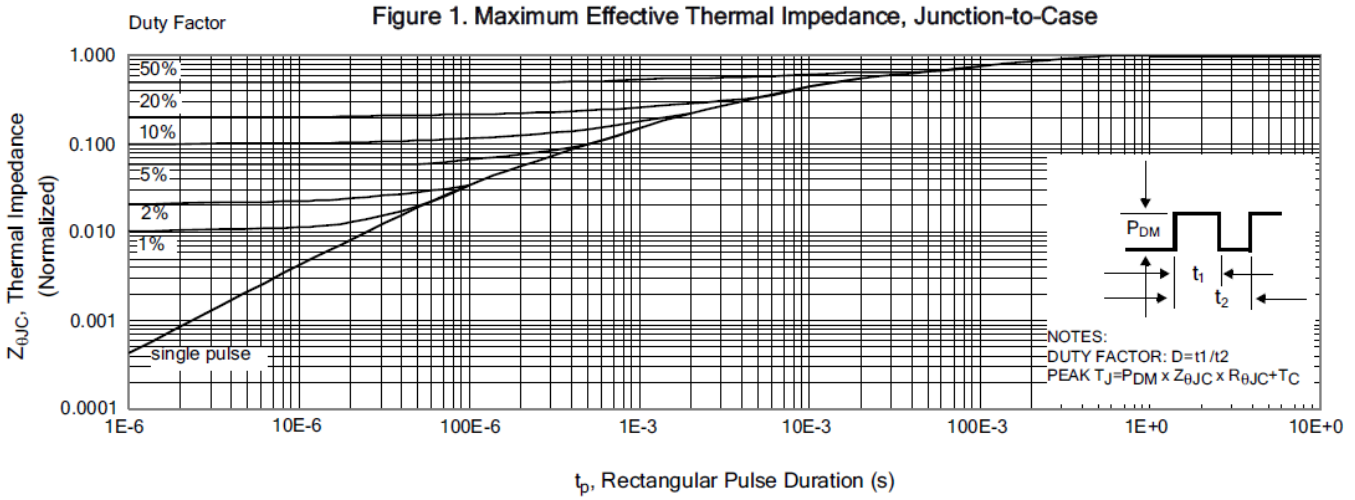

Figure 2. Maximum Power Dissipation vs Case Temperature

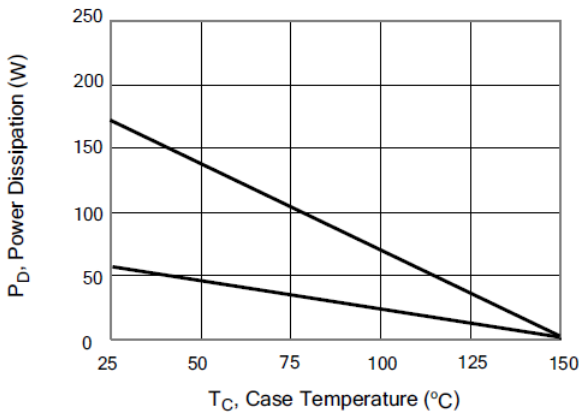

Figure 3. Maximum Continuous Drain Current vs Case Temperature

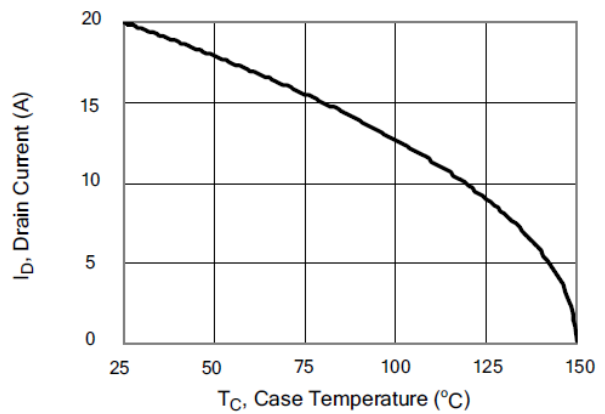

Figure 4. Typical Output Characteristics

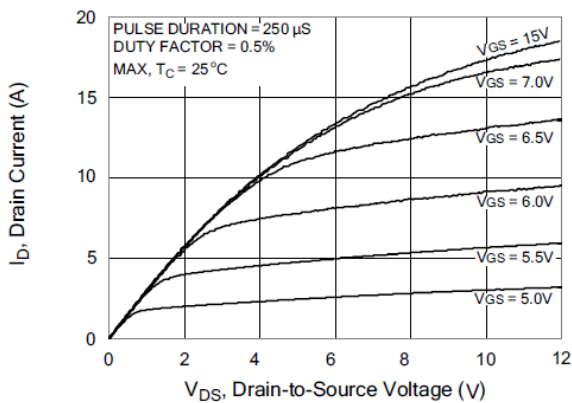

Figure 5. Typical Drain-to-Source ON Resistance vs Gate Voltage and Drain Current

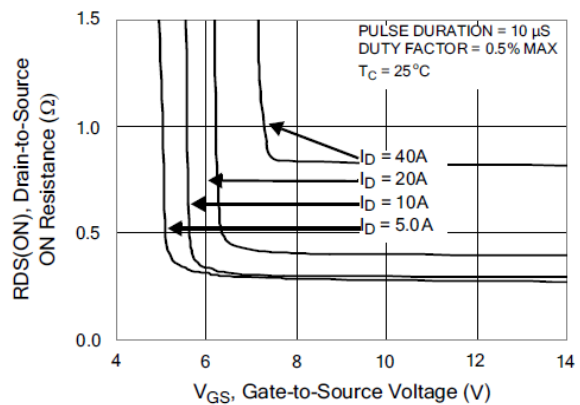



Figure 6. Maximum Peak Current Capability

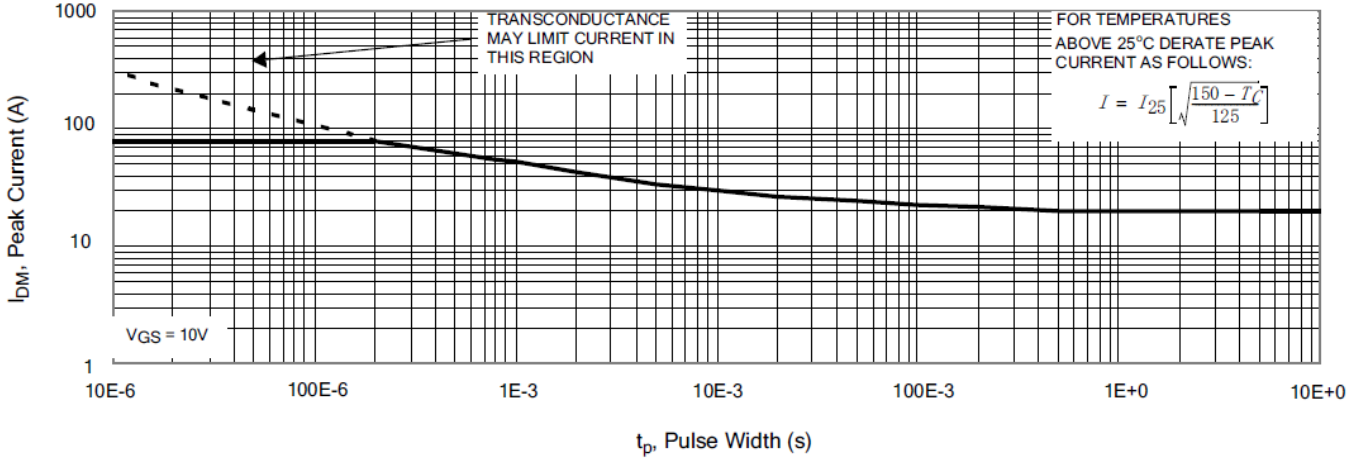

Figure 7. Typical Transfer Characteristics

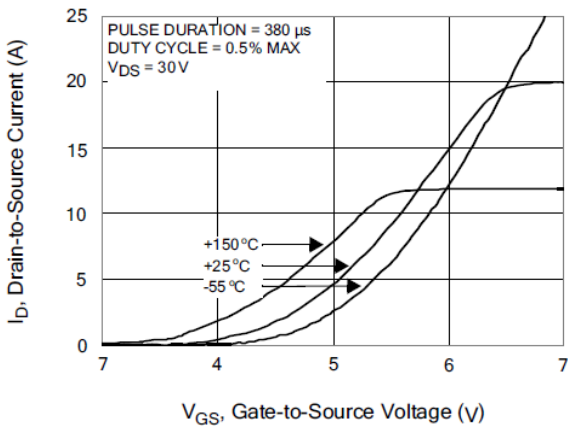

Figure 8. Unclamped Inductive Switching Capability

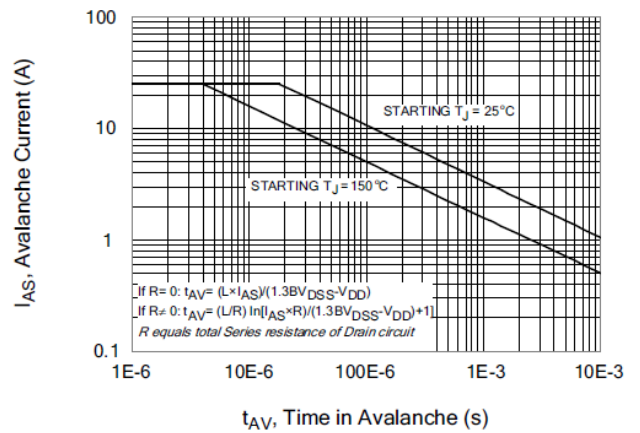

Figure 9. Typical Drain-to-Source ON Resistance vs Drain Current

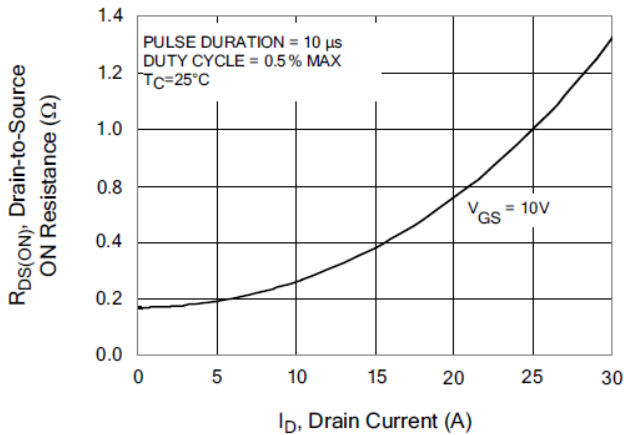

Figure 10. Typical Drain-to-Source ON Resistance vs Junction Temperature

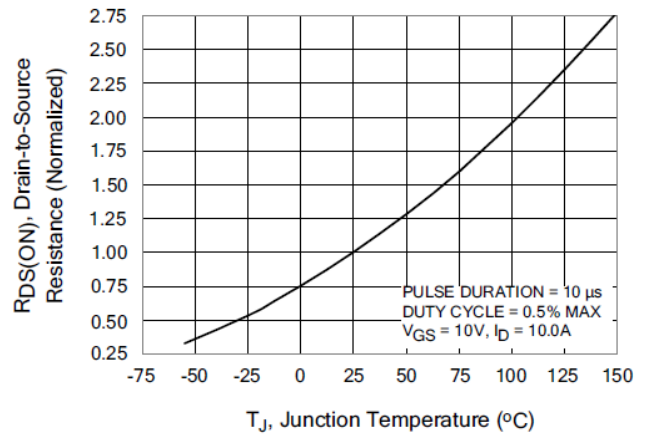



Figure 11. Typical Breakdown Voltage vs Junction Temperature

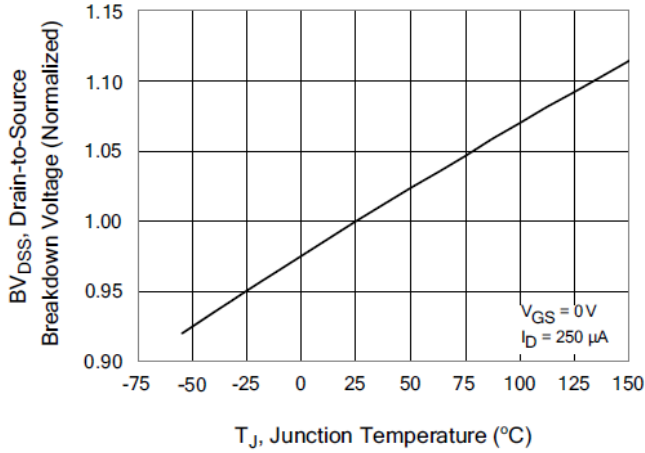

Figure 12. Typical Threshold Voltage vs Junction Temperature

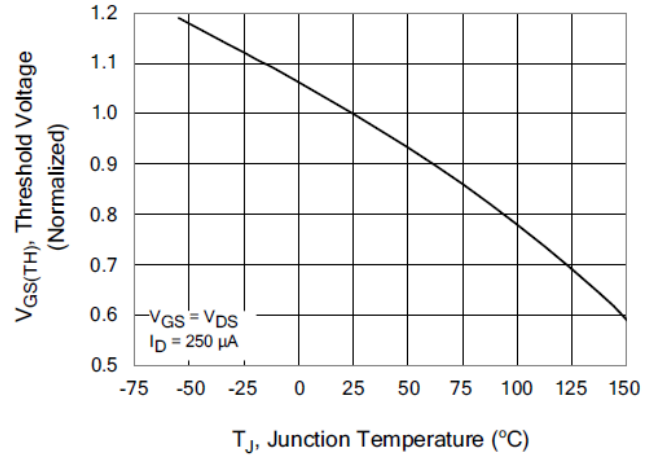

Figure 13. Maximum Forward Bias Safe Operating Area

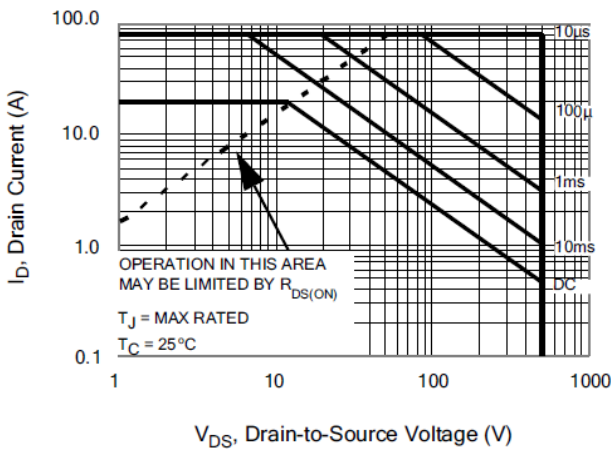

Figure 14. Typical Capacitance vs Drain-to-Source Voltage

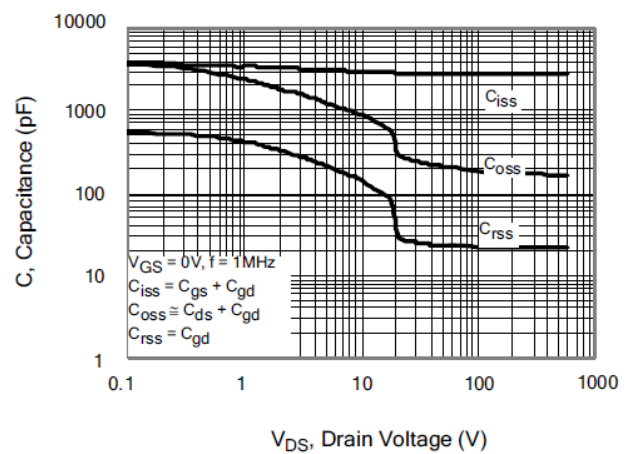

Figure 15. Typical Gate Charge vs Gate-to-Source Voltage

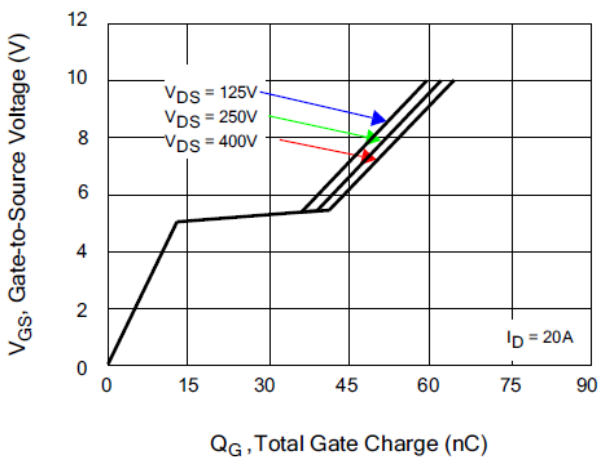
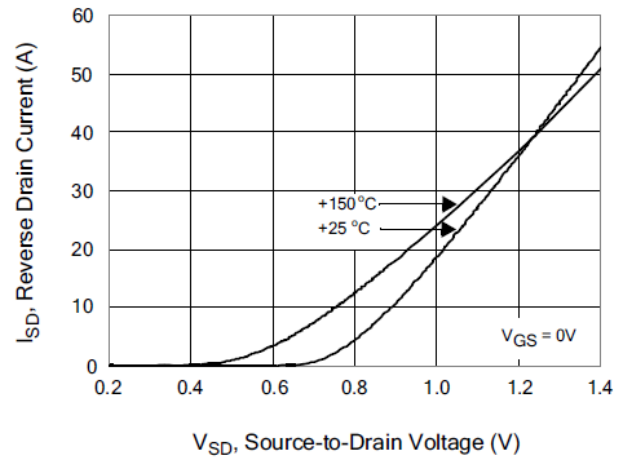
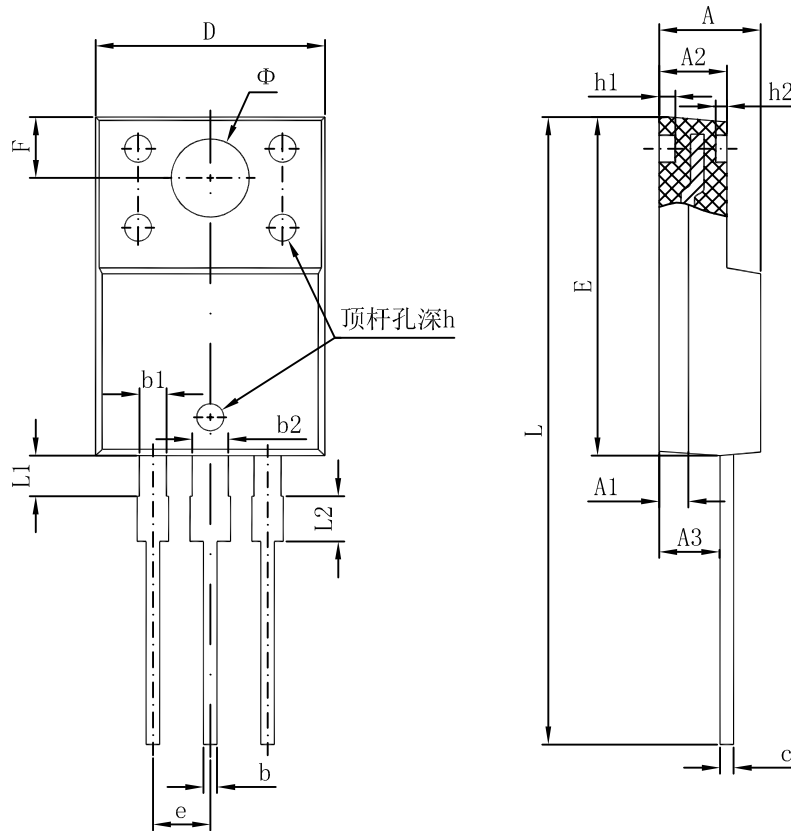

Figure 16. Typical Body Diode Transfer Characteristics





Package Dimension TO-220F



Symbol	Dimensions In Millimeters		Dimensions In Inches	
	Min.	Max.	Min.	Max.
A	4.300	4.700	0.169	0.185
A1	1.300 REF.		0.051 REF.	
A2	2.800	3.200	0.110	0.126
A3	2.500	2.900	0.098	0.114
b	0.500	0.750	0.020	0.030
b1	1.100	1.350	0.043	0.053
b2	1.500	1.750	0.059	0.069
c	0.500	0.750	0.020	0.030
D	9.960	10.360	0.392	0.408
E	14.800	15.200	0.583	0.598
e	2.540 TYP.		0.100 TYP.	
F	2.700 REF.		0.106 REF.	
Φ	3.500 REF.		0.138 REF.	
h	0.000	0.300	0.000	0.012
h1	0.800 REF.		0.031 REF.	
h2	0.500 REF.		0.020 REF.	
L	28.000	28.400	1.102	1.118
L1	1.700	1.900	0.067	0.075
L2	1.900	2.100	0.075	0.083



Attention

- Any and all HUA XUAN YANG ELECTRONICS products described or contained herein do not have specifications that can handle applications that require extremely high levels of reliability, such as life-support systems, aircraft's control systems, or other applications whose failure can be reasonably expected to result in serious physical and/or material damage. Consult with your HUA XUAN YANG ELECTRONICS representative nearest you before using any HUA XUAN YANG ELECTRONICS products described or contained herein in such applications.
- HUA XUAN YANG ELECTRONICS assumes no responsibility for equipment failures that result from using products at values that exceed, even momentarily, rated values (such as maximum ratings, operating condition ranges, or other parameters) listed in products specifications of any and all HUA XUAN YANG ELECTRONICS products described or contained herein.
- Specifications of any and all HUA XUAN YANG ELECTRONICS products described or contained herein stipulate the performance, characteristics, and functions of the described products in the independent state, and are not guarantees of the performance, characteristics, and functions of the described products as mounted in the customer's products or equipment. To verify symptoms and states that cannot be evaluated in an independent device, the customer should always evaluate and test devices mounted in the customer's products or equipment.
- HUA XUAN YANG ELECTRONICS CO.,LTD. strives to supply high-quality high-reliability products. However, any and all semiconductor products fail with some probability. It is possible that these probabilistic failures could give rise to accidents or events that could endanger human lives, that could give rise to smoke or fire, or that could cause damage to other property. When designing equipment, adopt safety measures so that these kinds of accidents or events cannot occur. Such measures include but are not limited to protective circuits and error prevention circuits for safe design, redundant design, and structural design.
- In the event that any or all HUA XUAN YANG ELECTRONICS products(including technical data, services) described or contained herein are controlled under any of applicable local export control laws and regulations, such products must not be exported without obtaining the export license from the authorities concerned in accordance with the above law.
- No part of this publication may be reproduced or transmitted in any form or by any means, electronic or mechanical, including photocopying and recording, or any information storage or retrieval system, or otherwise, without the prior written permission of HUA XUAN YANG ELECTRONICS CO.,LTD.
- Information (including circuit diagrams and circuit parameters) herein is for example only ; it is not guaranteed for volume production. HUA XUAN YANG ELECTRONICS believes information herein is accurate and reliable, but no guarantees are made or implied regarding its use or any infringements of intellectual property rights or other rights of third parties.
- Any and all information described or contained herein are subject to change without notice due to product/technology improvement, etc. When designing equipment, refer to the "Delivery Specification" for the HUA XUAN YANG ELECTRONICS product that you intend to use.