



Description

The STD130N6F7 can be used in various power switching circuit for system miniaturization and higher efficiency. The package form is TO-252-2L, which accords with the RoHS standard.

General Features

$V_{DS} = 60V$ $I_D = 120A$

$R_{DS(ON)} < 5.9m\Omega @ V_{GS}=10V$

Application

Battery protection

Load switch

Uninterruptible power supply

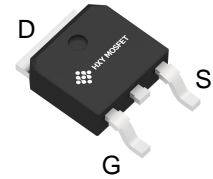

TO-252-2L
(DPAK)

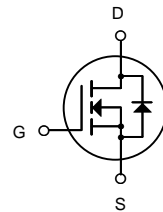

N-Channel MOSFET

Ordering Information

Product ID	Pack	Brand	Qty(PCS)
STD130N6F7	TO-252-2L(DPAK)	HXY MOSFET	2500

Absolute Maximum Ratings $T_c=25^\circ C$ unless otherwise noted

Symbol	Parameter	Rating	Units
V_{DS}	Drain-Source Voltage	60	V
V_{GS}	Gate-Source Voltage	± 20	V
$I_D@T_c=25^\circ C$	Continuous Drain Current, $V_{GS} @ 10V$	120	A
$I_D@T_c=100^\circ C$	Continuous Drain Current, $V_{GS} @ 10V$	72	A
I_{DM}	Pulsed Drain Current	600	A
EAS	Single Pulse Avalanche Energy	272	mJ
$P_D@T_c=25^\circ C$	Total Power Dissipation	125	W
T_{STG}	Storage Temperature Range	-55 to 150	$^\circ C$
T_J	Operating Junction Temperature Range	-55 to 150	$^\circ C$
$R_{\theta JC}$	Thermal Resistance Junction-Case	1	$^\circ C/W$



Electrical Characteristics ($T_J=25^{\circ}\text{C}$ unless otherwise specified)

Symbol	Parameter	Conditions	Min.	Typ.	Max.	Unit
BV_{DSS}	Drain-Source Breakdown Voltage	$V_{GS}=0V, I_D=250\mu A$	60	---	---	V
$\Delta BV_{DSS}/\Delta T_J$	BV_{DSS} Temperature Coefficient	Reference to $25^{\circ}\text{C}, I_D=1\text{mA}$	---	---	---	$V/^{\circ}\text{C}$
$R_{DS(ON)}$	Static Drain-Source On-Resistance ²	$V_{GS}=10V, I_D=24A$	---	4.5	5.9	m Ω
		$V_{GS}=4.5V, I_D=15A$	---	---	---	
$V_{GS(th)}$	Gate Threshold Voltage	$V_{GS}=V_{DS}, I_D=-250\mu A$	2.4	3	3.6	V
$\Delta V_{GS(th)}$	$V_{GS(th)}$ Temperature Coefficient		---	---	---	$\text{mV}/^{\circ}\text{C}$
I_{DSS}	Drain-Source Leakage Current	$V_{DS}=60V, V_{GS}=0V, T_J=25^{\circ}\text{C}$	---	---	1	μA
		$V_{DS}=60V, V_{GS}=0V, T_J=125^{\circ}\text{C}$	---	---	---	
I_{GSS}	Gate-Source Leakage Current	$V_{GS}=\pm 20V, V_{DS}=0V$	---	---	± 100	nA
gfs	Forward Transconductance	$V_{DS}=10V, I_D=24A$	---	---	---	S
R_g	Gate Resistance	$V_{DS}=0V, V_{GS}=0V, f=1\text{MHz}$	---	---	---	Ω
Q_g	Total Gate Charge	$V_{DS}=30V, V_{GS}=10V, I_D=36A$	---	98	---	nC
Q_{gs}	Gate-Source Charge		---	13	---	
Q_{gd}	Gate-Drain Charge		---	30	---	
$T_{d(on)}$	Turn-On Delay Time	$V_{GS}=10V, V_{DS}=30V,$ $R_G=1.8\Omega, I_D=36A$	---	11	---	ns
T_r	Rise Time		---	8	---	
$T_{d(off)}$	Turn-Off Delay Time		---	47	---	
T_f	Fall Time		---	14	---	
C_{iss}	Input Capacitance	$V_{DS}=25V, V_{GS}=0V, f=1\text{MHz}$	---	5066	---	pF
C_{oss}	Output Capacitance		---	472	---	
C_{rss}	Reverse Transfer Capacitance		---	283	---	
I_S	Continuous Source Current ^{1,4}	$V_G=V_D=0V, \text{Force Current}$	---	---	120	A
V_{SD}	Diode Forward Voltage ²	$V_{GS}=0V, I_S=36A, T_J=25^{\circ}\text{C}$	---	---	1.2	V
t_{rr}	Reverse Recovery Time	$I_F=36A, di/dt=100A/\mu s,$	---	26	---	nS
Q_{rr}	Reverse Recovery Charge	$T_J=25^{\circ}\text{C}$	---	47	---	nC

Note :

- 1.Repetitive Rating: Pulse width limited by maximum junction temperature.
- 2.EAS condition: $T_J=25^{\circ}\text{C}, V_{DD}=30V, V_G=10V, R_G=25\Omega, L=0.5\text{mH}, I_{AS}=40A$
- 3.Repetitive Rating: Pulse width limited by maximum junction temperature.



Typical Performance Characteristics

Figure 1. Output Characteristics

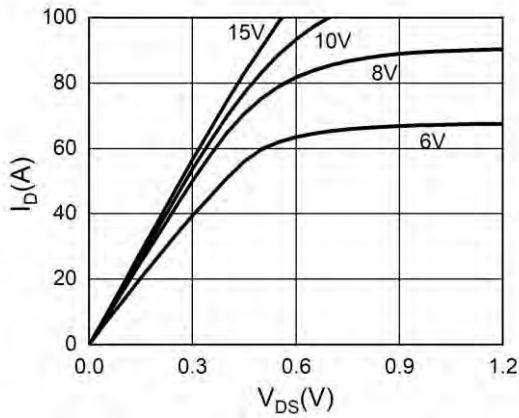

Figure 2. Transfer Characteristics

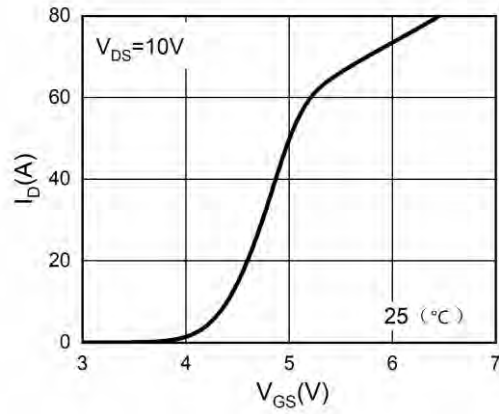

Figure 3. Power Dissipation

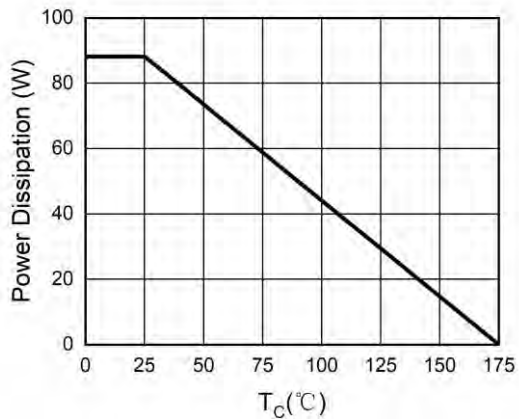

Figure 4. Drain Current

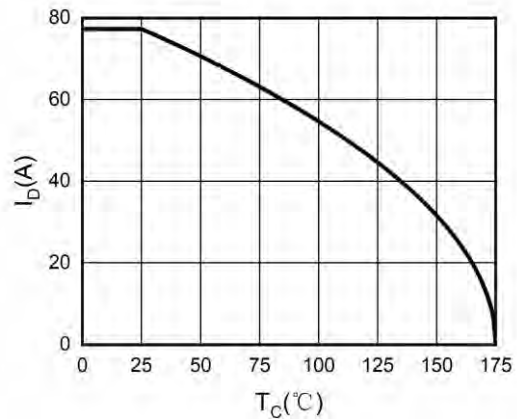

Figure 5. BV_{DSS} vs Junction Temperature

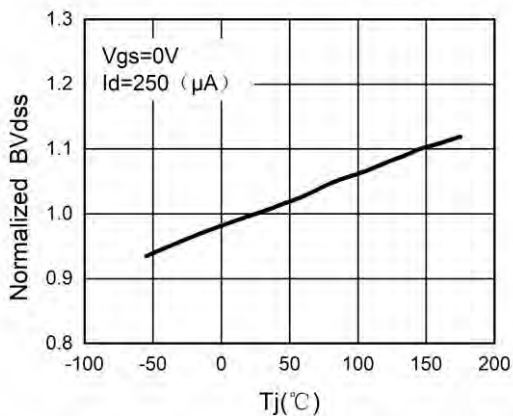

Figure 6. $R_{DS(ON)}$ vs Junction Temperature

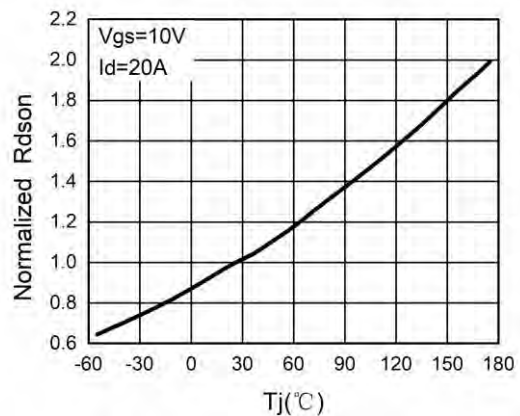



Figure 7. Gate Charge Waveforms

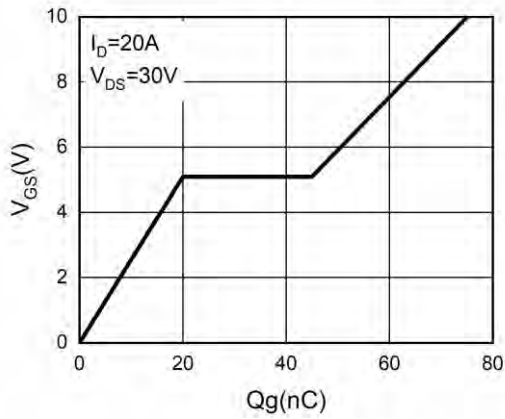

Figure 8. Capacitance

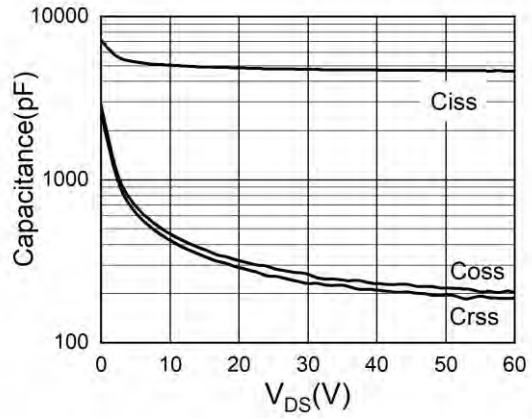

Figure 9. Body-Diode Characteristics

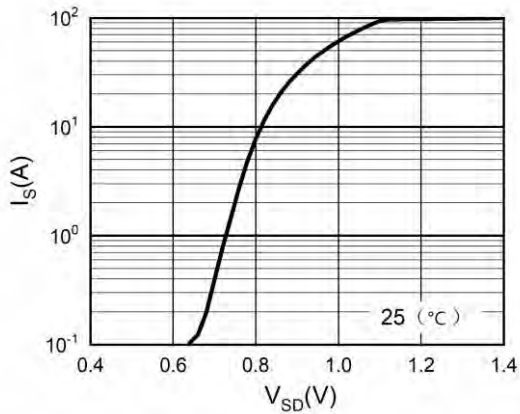
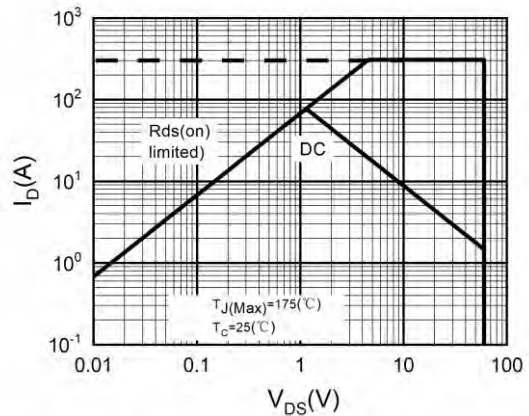
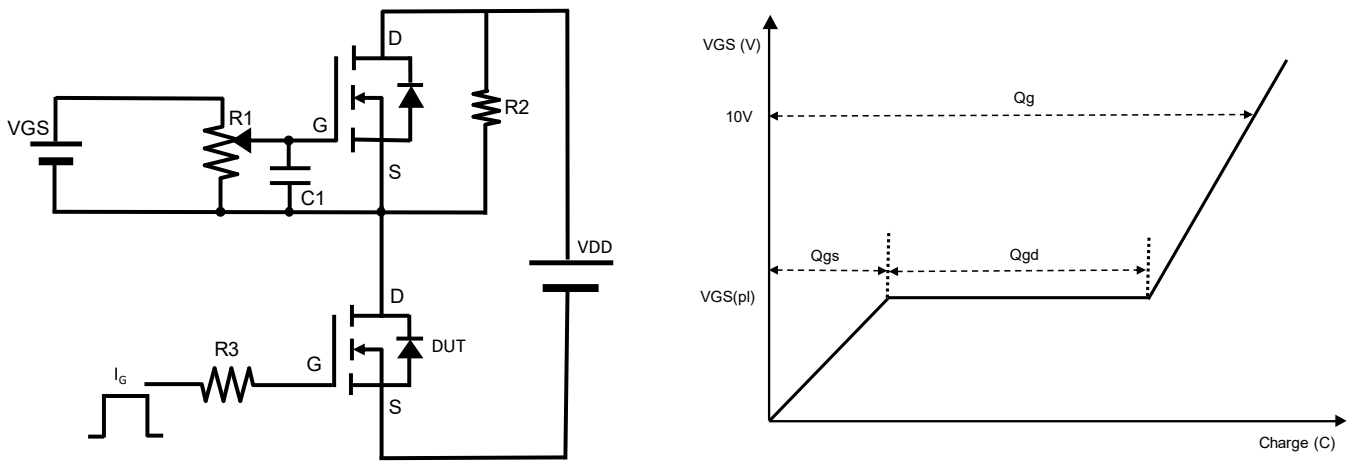
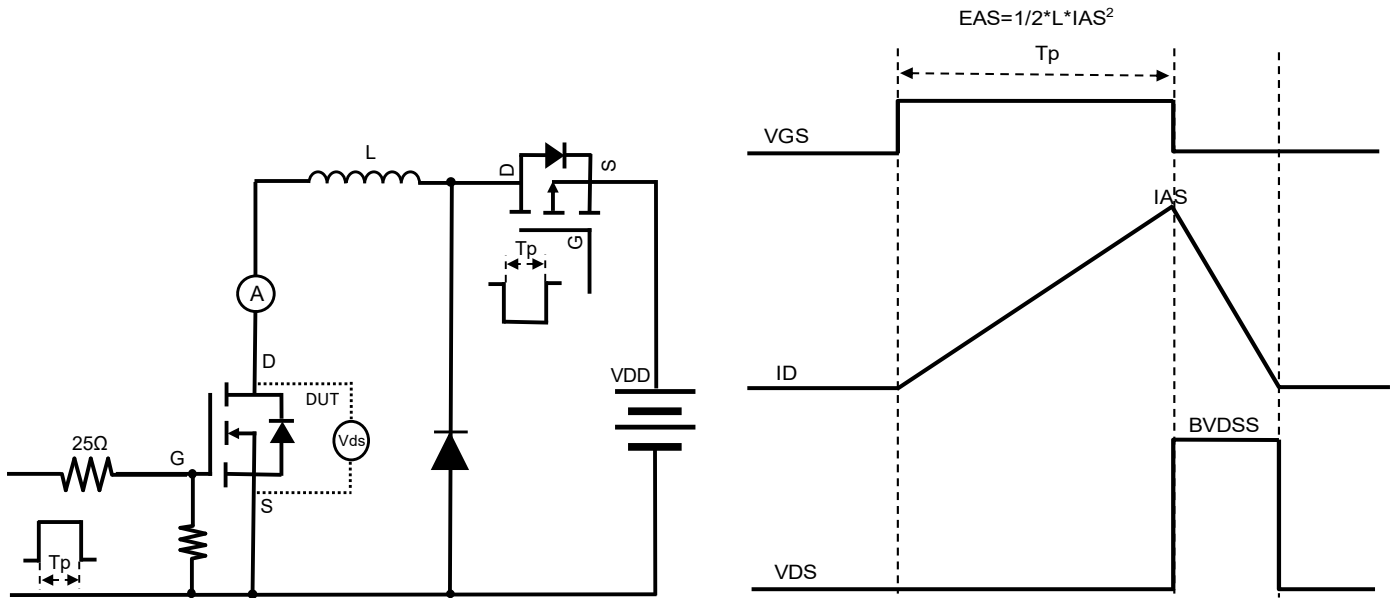

Figure 10. Maximum Safe Operating Area





Test Circuits & Waveforms





TO-252-2L(DPAK) Package Information

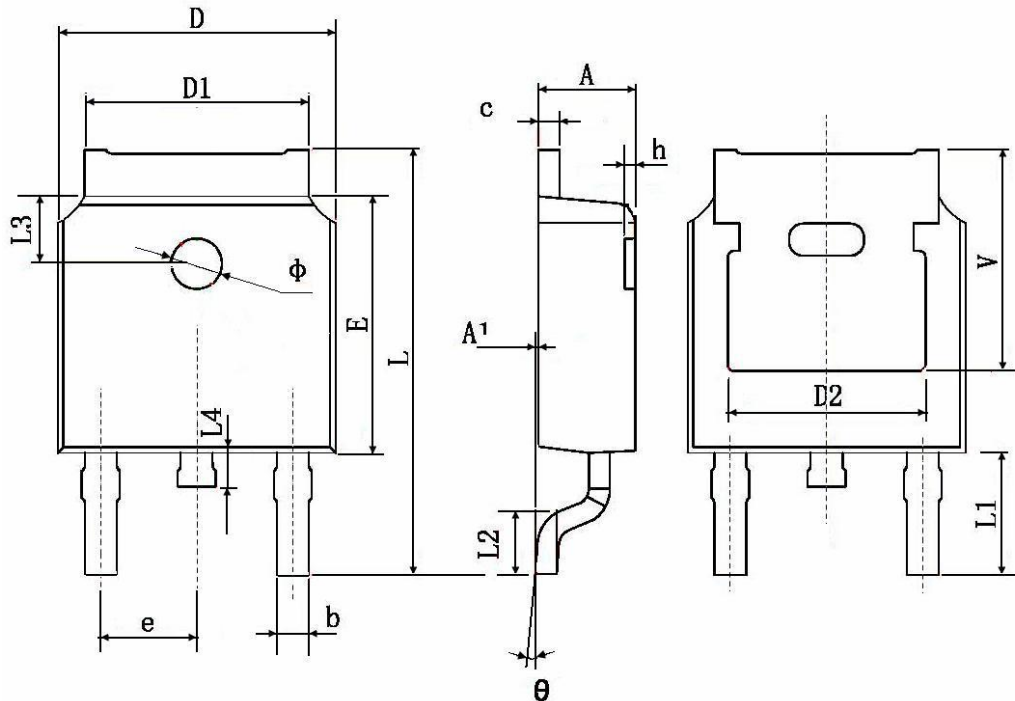

Symbol	Dimensions In Millimeters		Dimensions In Inches	
	Min.	Max.	Min.	Max.
A	2.200	2.400	0.087	0.094
A1	0.000	0.127	0.000	0.005
b	0.660	0.860	0.026	0.034
c	0.460	0.580	0.018	0.023
D	6.500	6.700	0.256	0.264
D1	5.100	5.460	0.201	0.215
D2	0.483 TYP.		0.190 TYP.	
E	6.000	6.200	0.236	0.244
e	2.186	2.386	0.086	0.094
L	9.800	10.400	0.386	0.409
L1	2.900 TYP.		0.114 TYP.	
L2	1.400	1.700	0.055	0.067
L3	1.600 TYP.		0.063 TYP.	
L4	0.600	1.000	0.024	0.039
phi	1.100	1.300	0.043	0.051
theta	0°	8°	0°	8°
h	0.000	0.300	0.000	0.012
V	5.350 TYP.		0.211 TYP.	



Attention

- Any and all HUA XUAN YANG ELECTRONICS products described or contained herein do not have specifications that can handle applications that require extremely high levels of reliability, such as life-support systems, aircraft's control systems, or other applications whose failure can be reasonably expected to result in serious physical and/or material damage. Consult with your HUA XUAN YANG ELECTRONICS representative nearest you before using any HUA XUAN YANG ELECTRONICS products described or contained herein in such applications.
- HUA XUAN YANG ELECTRONICS assumes no responsibility for equipment failures that result from using products at values that exceed, even momentarily, rated values (such as maximum ratings, operating condition ranges, or other parameters) listed in products specifications of any and all HUA XUAN YANG ELECTRONICS products described or contained herein.
- Specifications of any and all HUA XUAN YANG ELECTRONICS products described or contained herein stipulate the performance, characteristics, and functions of the described products in the independent state, and are not guarantees of the performance, characteristics, and functions of the described products as mounted in the customer's products or equipment. To verify symptoms and states that cannot be evaluated in an independent device, the customer should always evaluate and test devices mounted in the customer's products or equipment.
- HUA XUAN YANG ELECTRONICS CO.,LTD. strives to supply high-quality high-reliability products. However, any and all semiconductor products fail with some probability. It is possible that these probabilistic failures could give rise to accidents or events that could endanger human lives, that could give rise to smoke or fire, or that could cause damage to other property. When designing equipment, adopt safety measures so that these kinds of accidents or events cannot occur. Such measures include but are not limited to protective circuits and error prevention circuits for safe design, redundant design, and structural design.
- In the event that any or all HUA XUAN YANG ELECTRONICS products(including technical data, services) described or contained herein are controlled under any of applicable local export control laws and regulations, such products must not be exported without obtaining the export license from the authorities concerned in accordance with the above law.
- No part of this publication may be reproduced or transmitted in any form or by any means, electronic or mechanical, including photocopying and recording, or any information storage or retrieval system, or otherwise, without the prior written permission of HUA XUAN YANG ELECTRONICS CO.,LTD.
- Information (including circuit diagrams and circuit parameters) herein is for example only ; it is not guaranteed for volume production. HUA XUAN YANG ELECTRONICS believes information herein is accurate and reliable, but no guarantees are made or implied regarding its use or any infringements of intellectual property rights or other rights of third parties.
- Any and all information described or contained herein are subject to change without notice due to product/technology improvement, etc. When designing equipment, refer to the "Delivery Specification" for the HUA XUAN YANG ELECTRONICS product that you intend to use.