

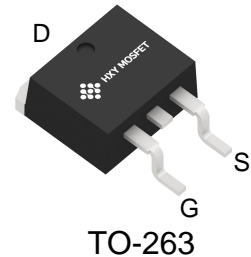

## General Description

The S70030E-GE3 use advanced SGT MOSFET technology to provide low RDS(ON), low gate charge, fast switching and excellent avalanche characteristics. This device is specially designed to get better ruggedness and suitable.



## General Features

$V_{DS} = 100V$   $I_D = 260A$   
 $R_{DS(ON)} < 4.2m\Omega @ V_{GS} = 10V$

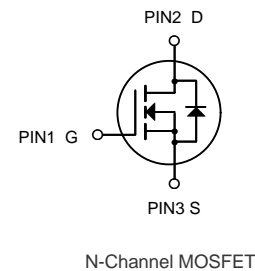

## Applications

Consumer electronic power supply Motor control  
Synchronous-rectification Isolated DC  
Synchronous-rectification applications

## Ordering Information

Product ID	Pack	Brand	Qty(PCS)
SUM70030E-GE3	TO-263	HXY MOSFET	800

## Absolute Maximum Ratings at $T_j = 25^\circ C$ unless otherwise noted

Parameter	Symbol	Value	Unit
Drain-Source Voltage	$V_{DS}$	100	V
Gate-Source Voltage	$V_{GS}$	$\pm 20$	V
Continuous Drain Current	$I_D$	$T_C = 25^\circ C$	260
		$T_C = 100^\circ C$	163
Pulsed Drain Current <sup>1</sup>	$I_{DM}$	1028	A
Single Pulse Avalanche Energy <sup>2</sup>	<b>EAS</b>	583	mJ
Total Power Dissipation	$T_C = 25^\circ C$	$P_D$	379
Operating Junction and Storage Temperature Range	$T_J, T_{STG}$	-55 to 150	$^\circ C$
Thermal Resistance from Junction-to-Ambient <sup>3</sup>	$R_{\theta JA}$	59	$^\circ C/W$
Thermal Resistance from Junction-to-Case	$R_{\theta JC}$	0.33	$^\circ C/W$



**Electrical Characteristics (T<sub>J</sub> = 25°C, unless otherwise noted)**

Parameter	Symbol	Test Conditions	Min.	Typ.	Max.	Unit
<b>Static Characteristics</b>						
Drain-Source Breakdown Voltage	V <sub>(BR)DSS</sub>	V <sub>GS</sub> = 0V, I <sub>D</sub> = 250μA	100	-	-	V
Gate-body Leakage current	I <sub>GSS</sub>	V <sub>DS</sub> = 0V, V <sub>GS</sub> = ±20V	-	-	±100	nA
Zero Gate Voltage Drain Current	T <sub>J</sub> =25°C	V <sub>DS</sub> =100V, V <sub>GS</sub> = 0V	-	-	1	μA
	T <sub>J</sub> =100°C		-	-	100	
Gate-Threshold Voltage	V <sub>GS(th)</sub>	V <sub>DS</sub> = V <sub>GS</sub> , I <sub>D</sub> = 250μA	2	3	4	V
Drain-Source on-Resistance <sup>4</sup>	R <sub>DS(on)</sub>	V <sub>GS</sub> = 10V, I <sub>D</sub> = 20A	-	3.4	4.2	mΩ
Forward Transconductance <sup>4</sup>	g <sub>fs</sub>	V <sub>DS</sub> =10V, I <sub>D</sub> =20A	-	76	-	S
<b>Dynamic Characteristics<sup>5</sup></b>						
Input Capacitance	C <sub>iss</sub>	V <sub>DS</sub> = 50V, V <sub>GS</sub> = 0V, f = 1MHz	-	9030	-	pF
Output Capacitance	C <sub>oss</sub>		-	1505	-	
Reverse Transfer Capacitance	C <sub>rss</sub>		-	40	-	
Gate Resistance	R <sub>g</sub>	f = 1MHz	-	2.3	-	Ω
<b>Switching Characteristics<sup>5</sup></b>						
Total Gate Charge	Q <sub>g</sub>	V <sub>GS</sub> = 10V, V <sub>DS</sub> = 50V, I <sub>D</sub> =20A	-	150	-	nC
Gate-Source Charge	Q <sub>gs</sub>		-	32.5	-	
Gate-Drain Charge	Q <sub>gd</sub>		-	49	-	
Turn-on Delay Time	t <sub>d(on)</sub>	V <sub>GS</sub> = 10V, V <sub>DD</sub> = 50V, R <sub>G</sub> = 3Ω, I <sub>D</sub> = 20A	-	27	-	ns
Rise Time	t <sub>r</sub>		-	78.5	-	
Turn-off Delay Time	t <sub>d(off)</sub>		-	110	-	
Fall Time	t <sub>f</sub>		-	86	-	
Body Diode Reverse Recovery Time	t <sub>rr</sub>	I <sub>F</sub> = 20A, dI/dt=100A/μs	-	88	-	ns
Body Diode Reverse Recovery Charge	Q <sub>rr</sub>		-	220	-	nC
<b>Drain-Source Body Diode Characteristics</b>						
Diode Forward Voltage <sup>4</sup>	V <sub>SD</sub>	I <sub>D</sub> = 20A, V <sub>GS</sub> = 0V	-	-	1.2	V
Continuous Source Current	I <sub>S</sub>	T <sub>C</sub> =25°C	-	-	260	A

Notes:

1. Repetitive rating, pulse width limited by junction temperature T<sub>J(MAX)</sub>=150°C.
2. The EAS data shows Max. rating . The test condition is V<sub>DD</sub>=50V, V<sub>GS</sub>=10V, L=0.4mH, I<sub>AS</sub>=54A.
3. The data tested by surface mounted on a 1 inch2 FR-4 board with 2OZ copper, The value in any given application depends on the user's specific board design.
4. The data tested by pulsed , pulse width ≤ 300us , duty cycle ≤ 2%.
5. This value is guaranteed by design hence it is not included in the production test.



## Typical Characteristics

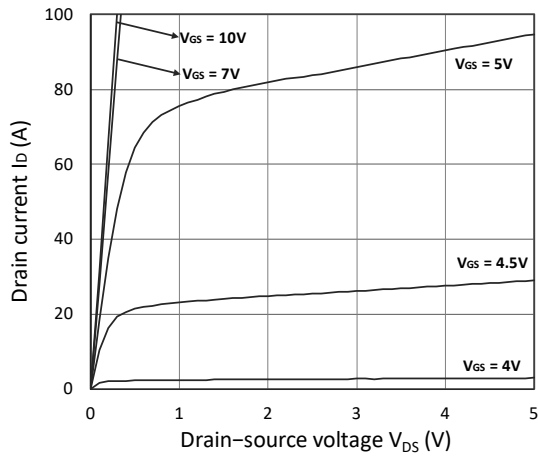

Figure 1. Output Characteristics

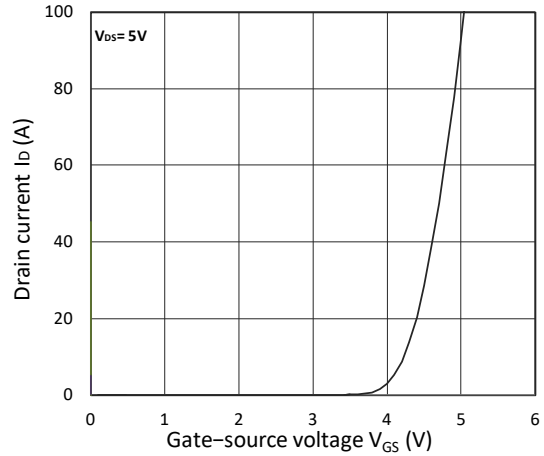

Figure 2. Transfer Characteristics

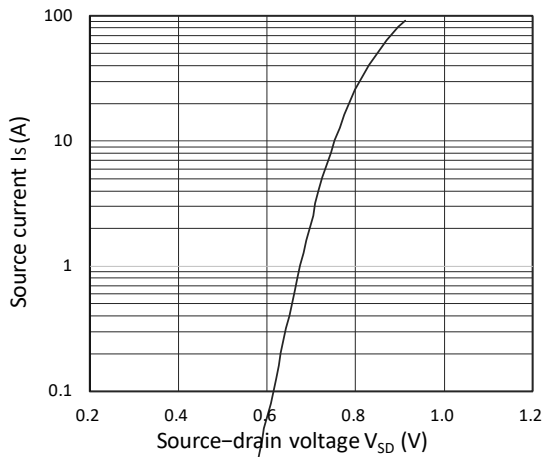

Figure 3. Forward Characteristics of Reverse

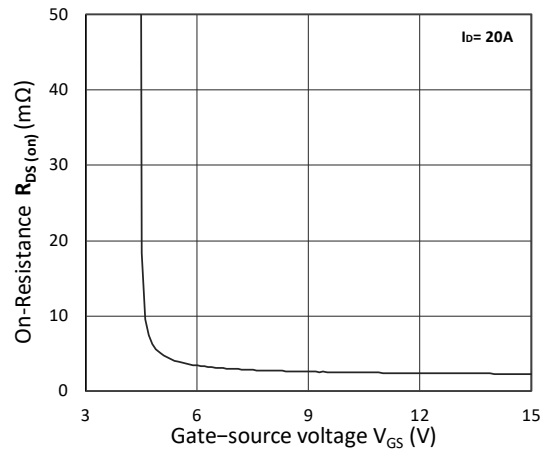

Figure 4.  $R_{DS(on)}$  vs.  $V_{GS}$

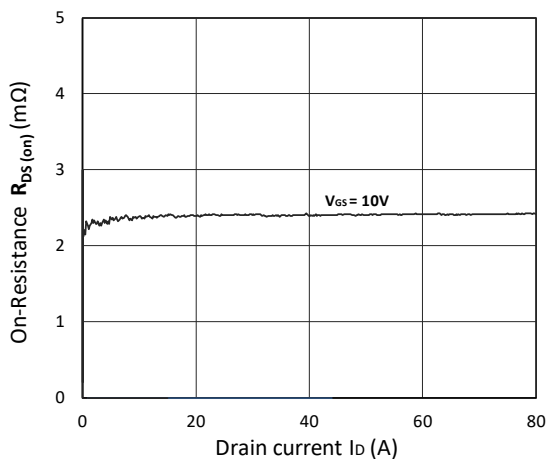

Figure 5.  $R_{DS(on)}$  vs.  $I_D$

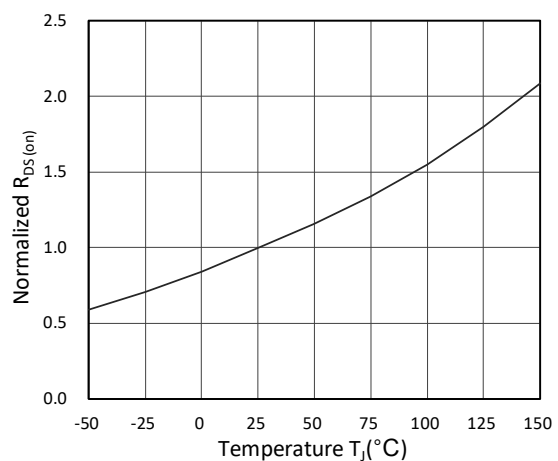

Figure 6. Normalized  $R_{DS(on)}$  vs. Temperature

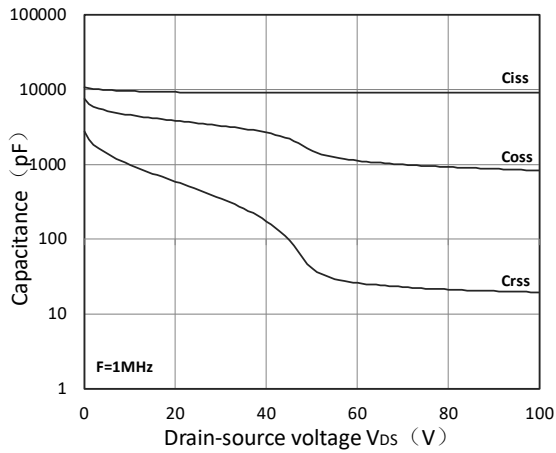

Figure 7. Capacitance Characteristics

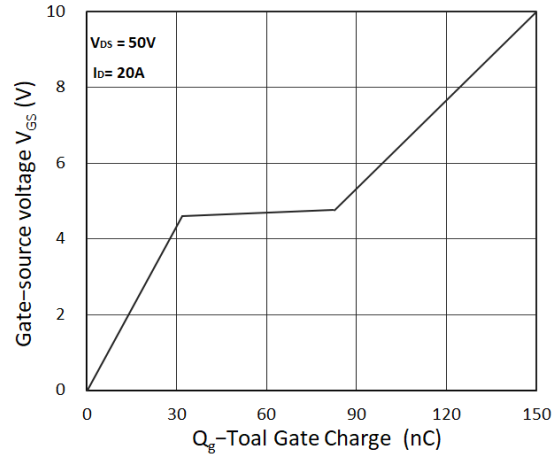

Figure 8. Gate Charge Characteristics

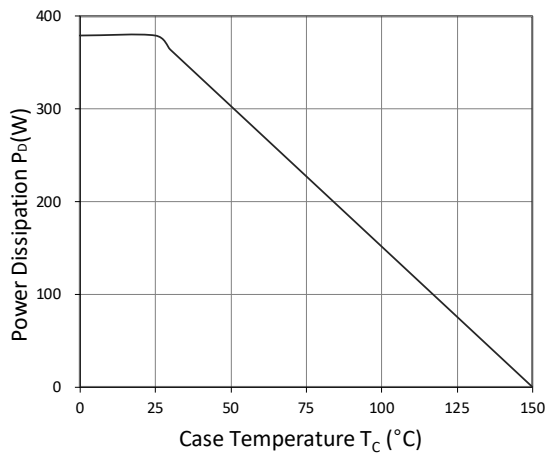

Figure 9. Power Dissipation

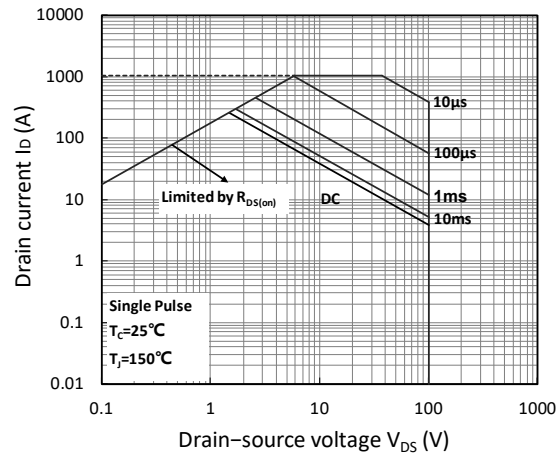

Figure 10. Safe Operating Area

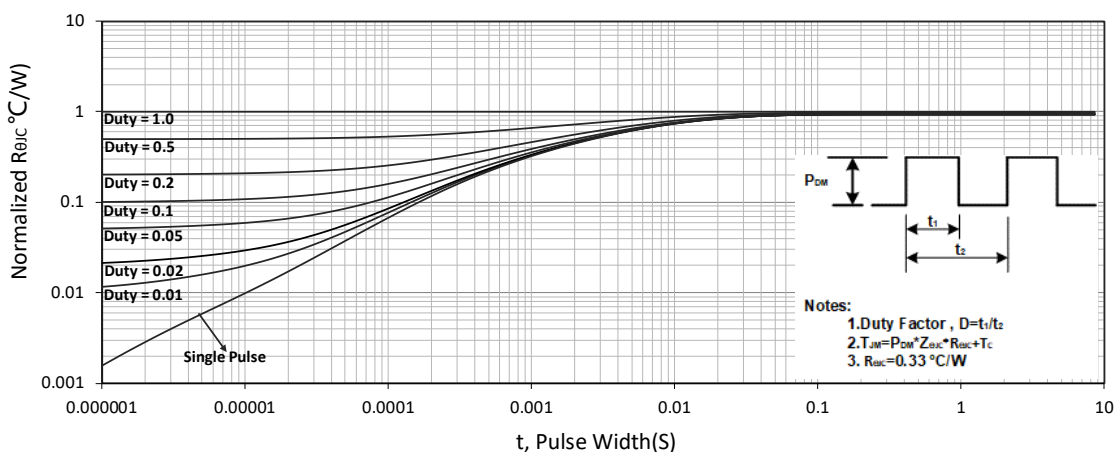

Figure 11. Normalized Maximum Transient Thermal Impedance



### Test Circuit

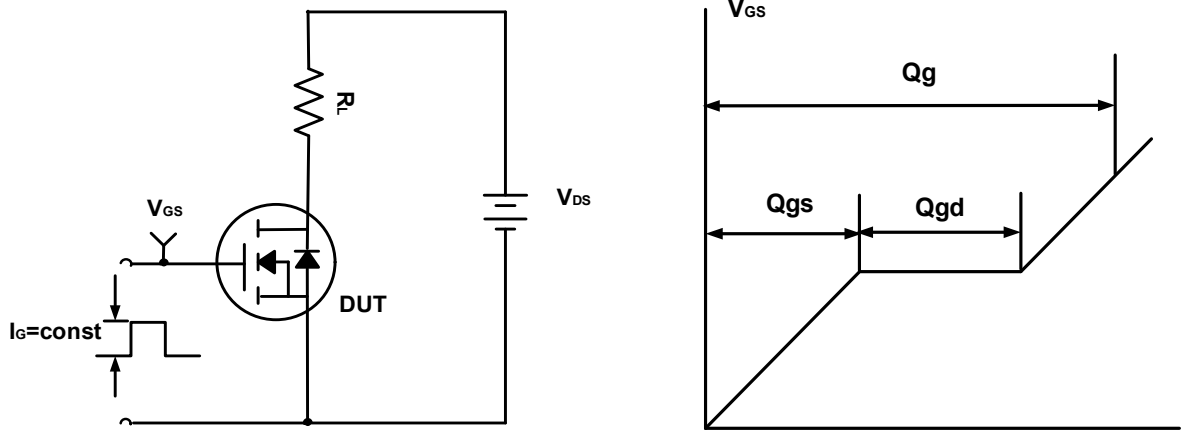

Figure A. Gate Charge Test Circuit & Waveforms

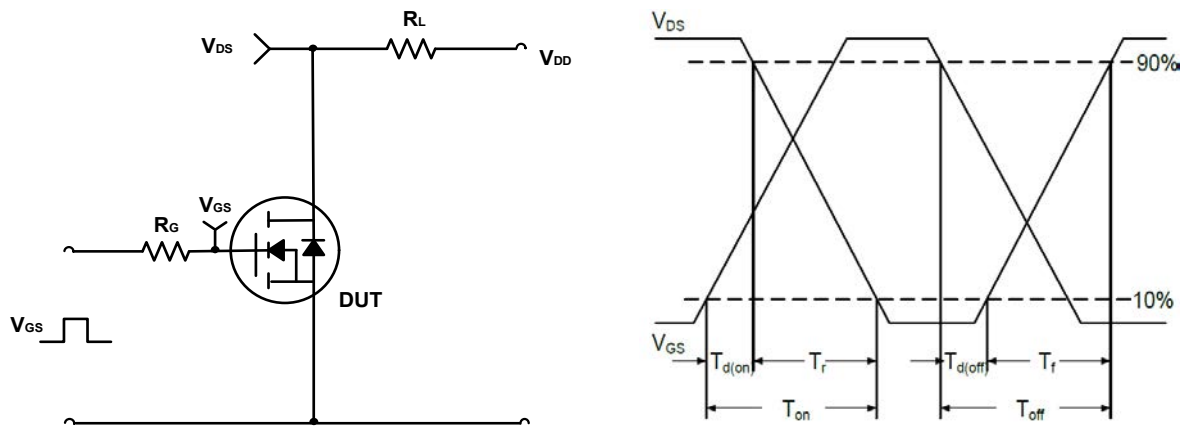

Figure B. Switching Test Circuit & Waveforms

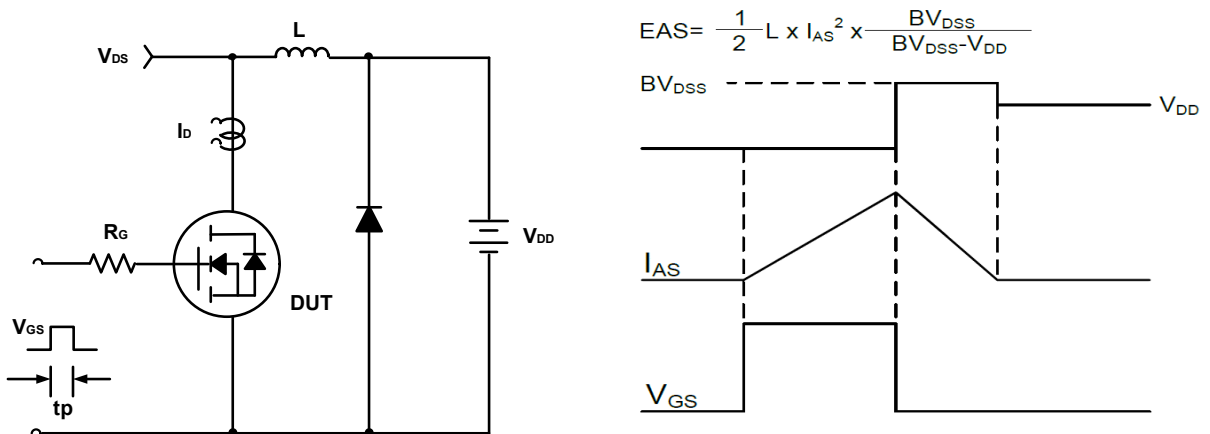
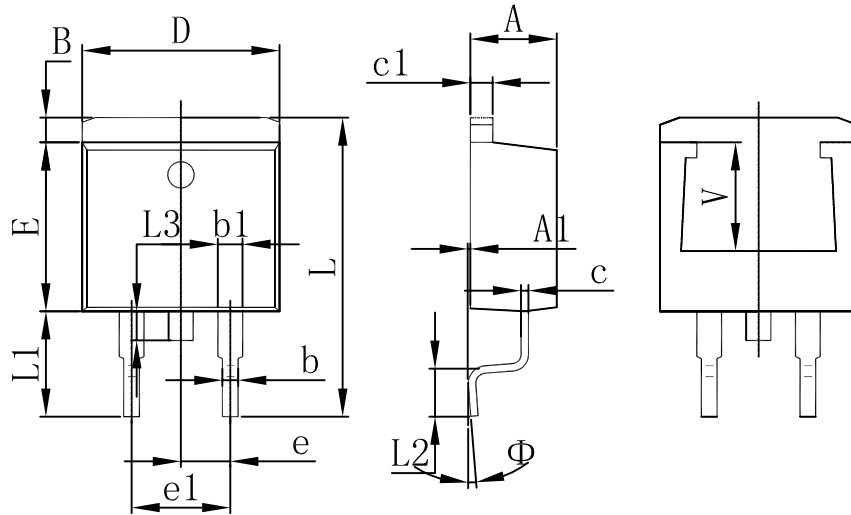

Figure C. Unclamped Inductive Switching Circuit & Waveforms



### TO-263 Package Outline Dimensions



Symbol	Dimensions In Millimeters		Dimensions In Inches	
	Min.	Max.	Min.	Max.
A	4.470	4.670	0.176	0.184
A1	0.000	0.150	0.000	0.006
B	1.120	1.420	0.044	0.056
b	0.710	0.910	0.028	0.036
b1	1.170	1.370	0.046	0.054
c	0.310	0.530	0.012	0.021
c1	1.170	1.370	0.046	0.054
D	10.010	10.310	0.394	0.406
E	8.500	8.900	0.335	0.350
e	2.540 TYP.		0.100 TYP.	
e1	4.980	5.180	0.196	0.204
L	14.940	15.500	0.588	0.610
L1	4.950	5.450	0.195	0.215
L2	2.340	2.740	0.092	0.108
L3	1.300	1.700	0.051	0.067
Φ	0°	8°	0°	8°
V	5.600 REF.		0.220REF.	



### Attention

- Any and all HUA XUAN YANG ELECTRONICS products described or contained herein do not have specifications that can handle applications that require extremely high levels of reliability, such as life-support systems, aircraft's control systems, or other applications whose failure can be reasonably expected to result in serious physical and/or material damage. Consult with your HUA XUAN YANG ELECTRONICS representative nearest you before using any HUA XUAN YANG ELECTRONICS products described or contained herein in such applications.
- HUA XUAN YANG ELECTRONICS assumes no responsibility for equipment failures that result from using products at values that exceed, even momentarily, rated values (such as maximum ratings, operating condition ranges, or other parameters) listed in products specifications of any and all HUA XUAN YANG ELECTRONICS products described or contained herein.
- Specifications of any and all HUA XUAN YANG ELECTRONICS products described or contained herein stipulate the performance, characteristics, and functions of the described products in the independent state, and are not guarantees of the performance, characteristics, and functions of the described products as mounted in the customer's products or equipment. To verify symptoms and states that cannot be evaluated in an independent device, the customer should always evaluate and test devices mounted in the customer's products or equipment.
- HUA XUAN YANG ELECTRONICS CO.,LTD. strives to supply high-quality high-reliability products. However, any and all semiconductor products fail with some probability. It is possible that these probabilistic failures could give rise to accidents or events that could endanger human lives, that could give rise to smoke or fire, or that could cause damage to other property. When designing equipment, adopt safety measures so that these kinds of accidents or events cannot occur. Such measures include but are not limited to protective circuits and error prevention circuits for safe design, redundant design, and structural design.
- In the event that any or all HUA XUAN YANG ELECTRONICS products(including technical data, services) described or contained herein are controlled under any of applicable local export control laws and regulations, such products must not be exported without obtaining the export license from the authorities concerned in accordance with the above law.
- No part of this publication may be reproduced or transmitted in any form or by any means, electronic or mechanical, including photocopying and recording, or any information storage or retrieval system, or otherwise, without the prior written permission of HUA XUAN YANG ELECTRONICS CO.,LTD.
- Information (including circuit diagrams and circuit parameters) herein is for example only ; it is not guaranteed for volume production. HUA XUAN YANG ELECTRONICS believes information herein is accurate and reliable, but no guarantees are made or implied regarding its use or any infringements of intellectual property rights or other rights of third parties.
- Any and all information described or contained herein are subject to change without notice due to product/technology improvement, etc. When designing equipment, refer to the "Delivery Specification" for the HUA XUAN YANG ELECTRONICS product that you intend to use.