



## Description

The NTTFS5C680NLTAG uses advanced trench technology to provide excellent  $R_{DS(ON)}$ , low gate charge and operation with gate voltages as low as 4.5V. This device is suitable for use as a Battery protection or in other Switching application.

## General Features

$V_{DS} = 60V$   $I_D = 20A$

$R_{DS(ON)} < 30m\Omega$  @  $V_{GS}=10V$

## Application

Battery protection

Load switch

Uninterruptible power supply

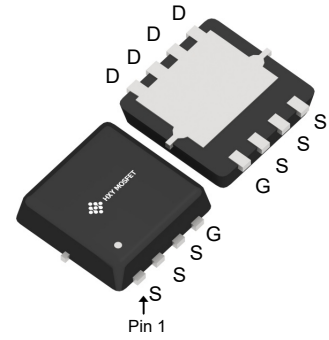

DFN3X3-8L

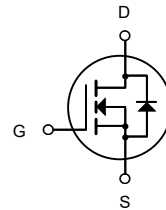

N-Channel MOSFET

## Ordering Information

Product ID	Pack	Brand	Qty(PCS)
NTTFS5C680NLTAG	DFN3X3-8L	HXY MOSFET	5000

## Absolute Maximum Ratings ( $T_C=25^\circ C$ unless otherwise noted)

Symbol	Parameter	Rating	Units
V <sub>DS</sub>	Drain-Source Voltage	60	V
V <sub>GS</sub>	Gate-Source Voltage	±20	V
$I_D@T_C=25^\circ C$	Continuous Drain Current, $V_{GS}$ @ 10V	20	A
$I_D@T_C=100^\circ C$	Continuous Drain Current, $V_{GS}$ @ 10V	14	A
IDM	Pulsed Drain Current	90	A
EAS	Single Pulse Avalanche Energy	42	mJ
$P_D@T_C=25^\circ C$	Total Power Dissipation	33	W
TSTG	Storage Temperature Range	-55 to 150	°C
T <sub>J</sub>	Operating Junction Temperature Range	-55 to 150	°C
R <sub>θJA</sub>	Thermal Resistance Junction-ambient	62	°C/W
R <sub>θJC</sub>	Thermal Resistance Junction-Case	3.79	°C/W



**Electrical Characteristics ( $T_J=25^{\circ}\text{C}$ , unless otherwise noted)**

Symbol	Parameter	Conditions	Min	Typ	Max	Units
$BV_{DSS}$	Drain-Source Breakdown Voltage	$V_{GS}=0V, I_D=250\mu A$	60	---	---	V
$I_{DSS}$	Drain-Source Leakage Current	$V_{GS}=0V, V_{DS}=60V$	---	---	1	$\mu A$
$I_{GSS}$	Gate-Source Leakage Current	$V_{GS}=\pm 20V, V_{DS}=0A$	---	---	$\pm 100$	nA
$V_{GS(th)}$	GATE-Source Threshold Voltage	$V_{GS}=V_{DS}, I_D=250\mu A$	1.2	1.8	2.5	V
$R_{DS(ON)}$	Drain-Source On Resistance <sup>3</sup>	$V_{GS}=10V, I_D=20A$	---	24	30	m $\Omega$
		$V_{GS}=4.5V, I_D=20A$	---	31	40	
$C_{iss}$	Input Capacitance	$V_{DS}=30V, V_{GS}=0V,$ $f=1MHz$	---	1060	---	pF
$C_{oss}$	Output Capacitance		---	64	---	
$C_{rss}$	Reverse Transfer Capacitance		---	54	---	
$t_{d(on)}$	Turn-On Delay Time	$V_{DD}=30V,$ $V_{GS}=10V,$ $I_D=20A, R_G=3\Omega$	---	8.4	---	ns
$t_r$	Rise Time		---	8.5	---	ns
$t_{d(off)}$	Turn-Off Delay Time		---	36	---	ns
$t_f$	Fall Time		---	5	---	ns
$Q_g$	Total Gate Charge	$V_{DS}=30V, V_{GS}=10V,$ $I_D=20A$	---	26	---	nC
$Q_{gs}$	Gate-Source Charge		---	5.7	---	nC
$Q_{gd}$	Gate-Drain "Miller" Charge		---	5.2	---	nC
$I_S$	Continuous Source Current	$V_G=V_D=0V$	---	---	20	A
$I_{SM}$	Pulsed Source Current	$V_G=V_D=0V$	---	---	90	A
$V_{SD}$	Forward on voltage	$I_S=20A, V_{GS}=0V$	---	---	1.2	V
$T_{rr}$	Body Diode Reverse Recovery Time	$I_F=20A, di/dt=100A/\mu s$	---	18	---	nS
$Q_{rr}$	Body Diode Reverse Recovery Charge		---	13	---	nC

**Notes:**

- 1)  $L=0.5mH, V_{DD}=30V, \text{Start } T_J=25^{\circ}\text{C}$ .
- 2) Limited by maximum junction temperature.
- 3) Repetitive Rating: Pulse width limited by maximum junction temperature



### Typical Characteristics

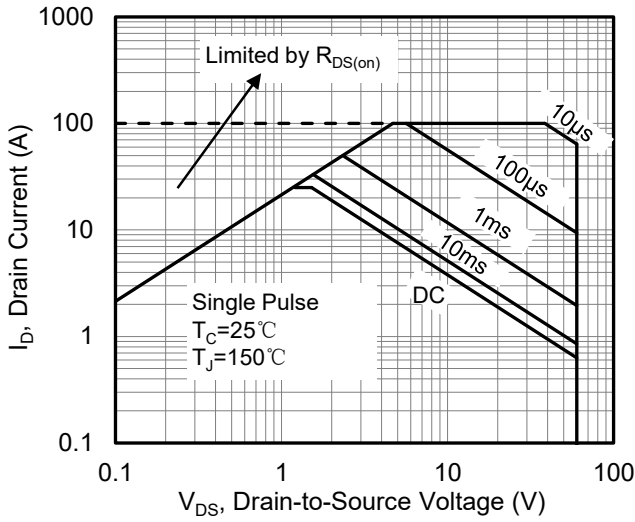

Figure 1. Maximum Safe Operating Area

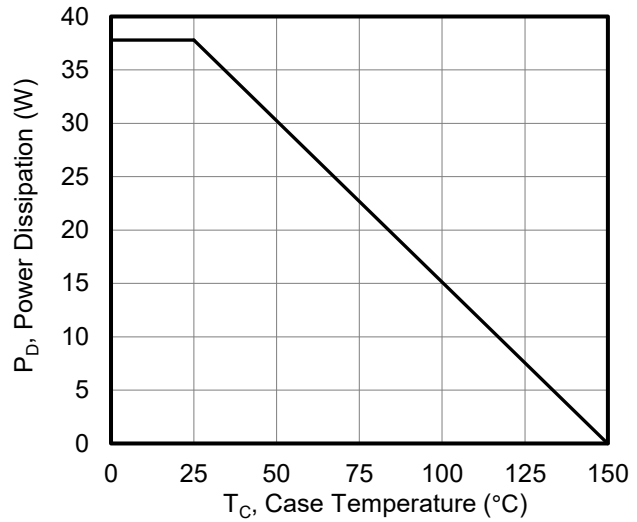

Figure 2. Maximum Power Dissipation vs. Case Temperature

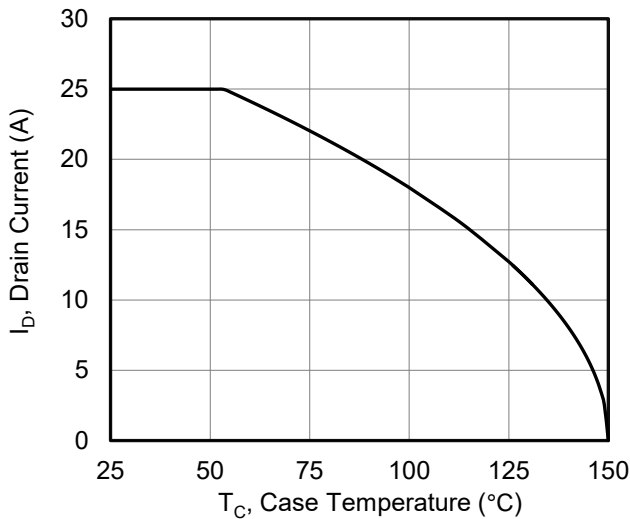

Figure 3. Maximum Continuous Drain Current vs. Case Temperature

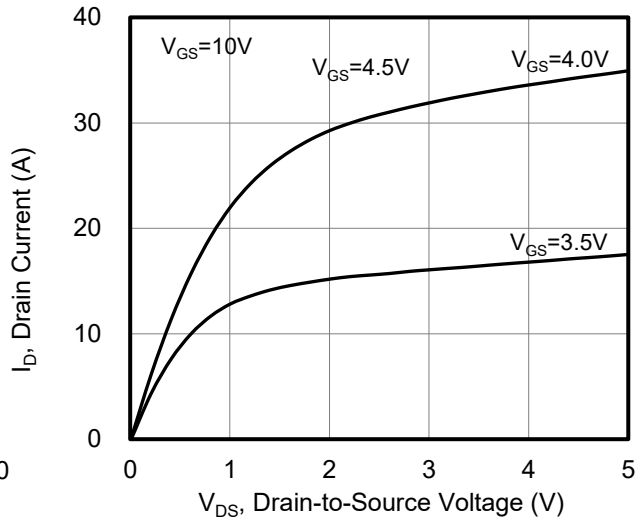

Figure 4. Typical output Characteristics

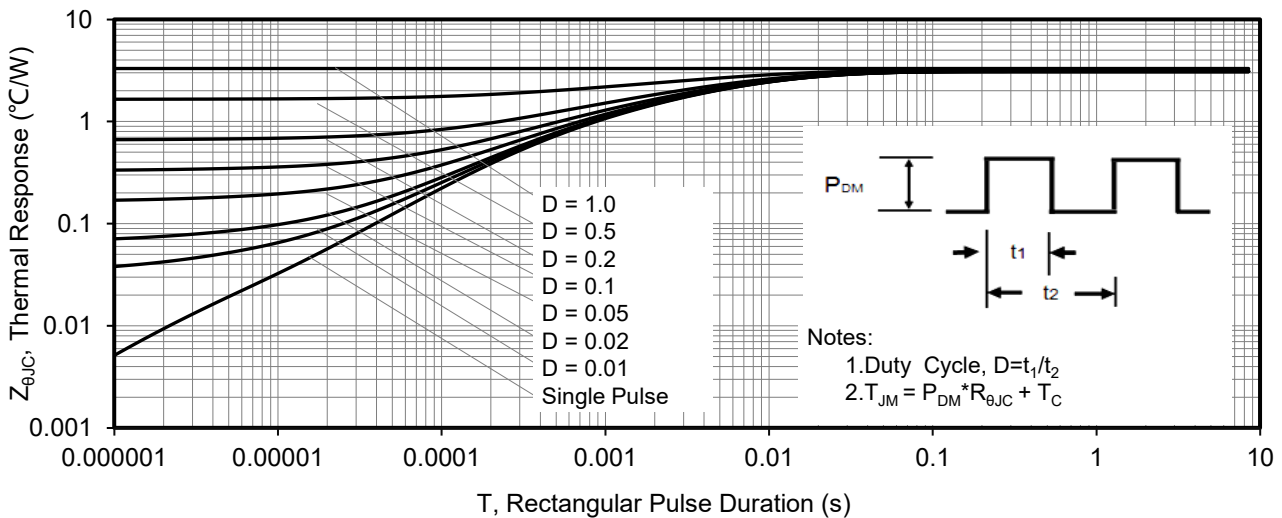

Figure 5. Maximum Effective Thermal Impedance, Junction to Case

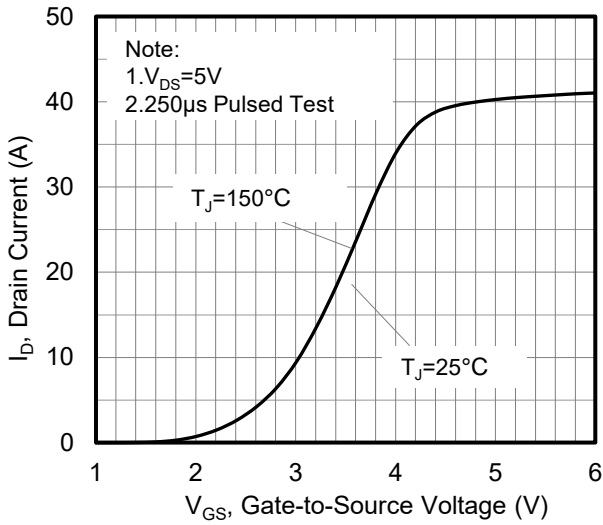

Figure 6. Typical Transfer Characteristics

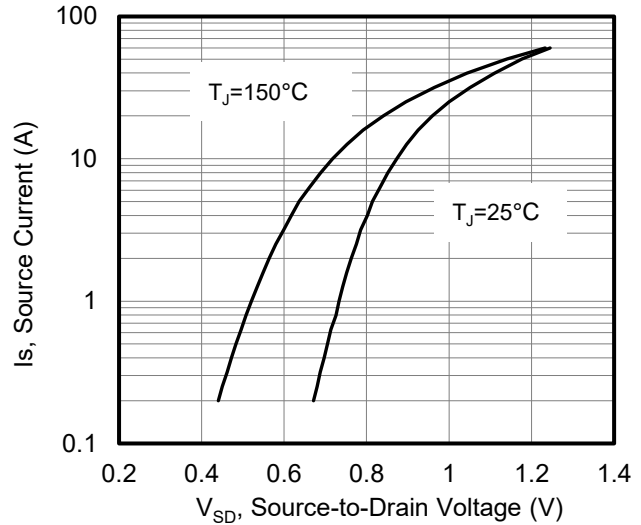

Figure 7. Typical Body Diode Transfer Characteristics

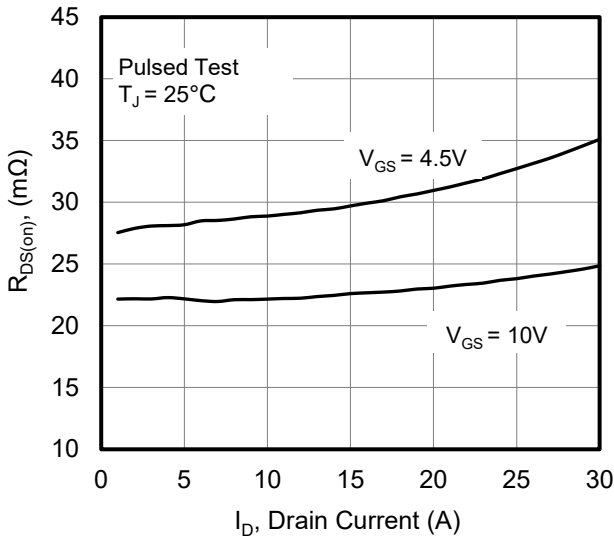

Figure 8. Drain-to-Source On Resistance vs Drain Current

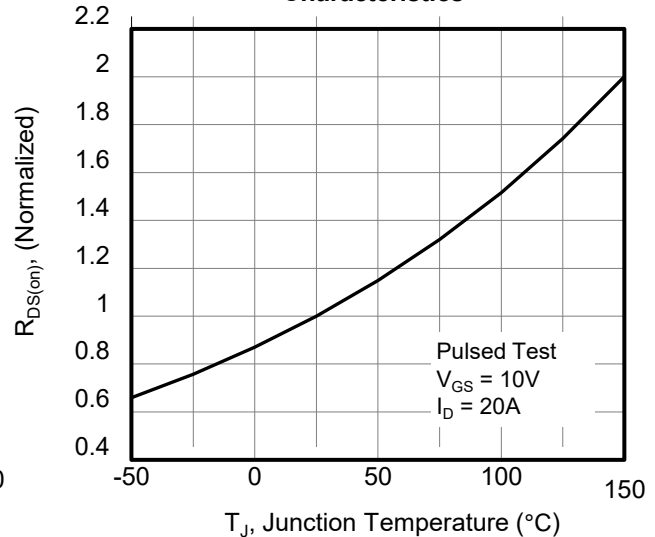

Figure 9. Normalized On Resistance vs Junction Temperature

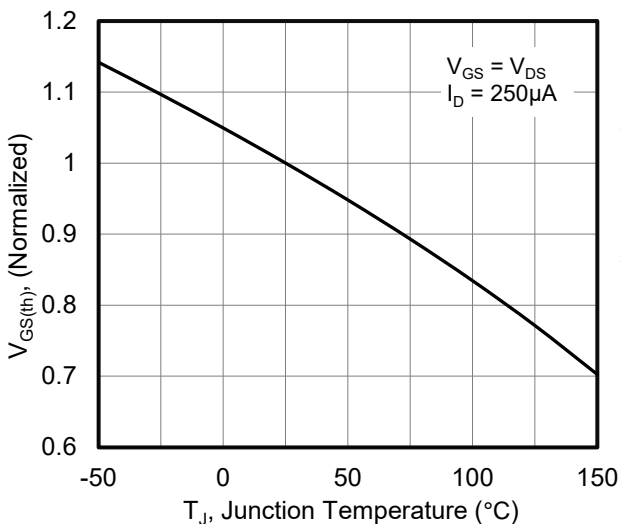

Figure 10. Normalized Threshold Voltage vs Junction Temperature

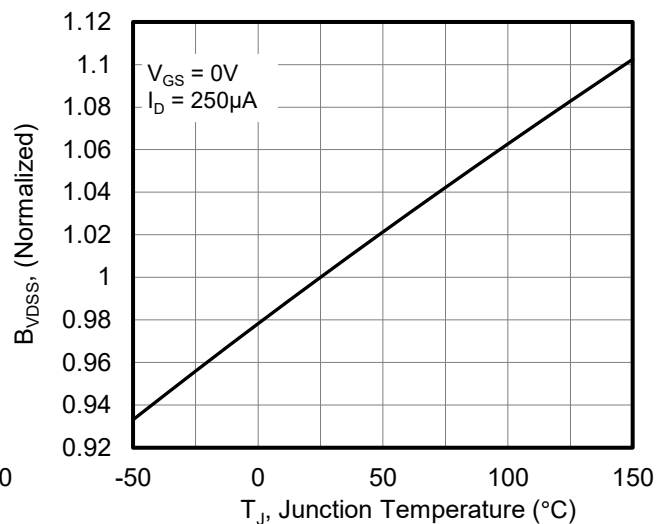

Figure 11. Normalized Breakdown Voltage vs Junction Temperature

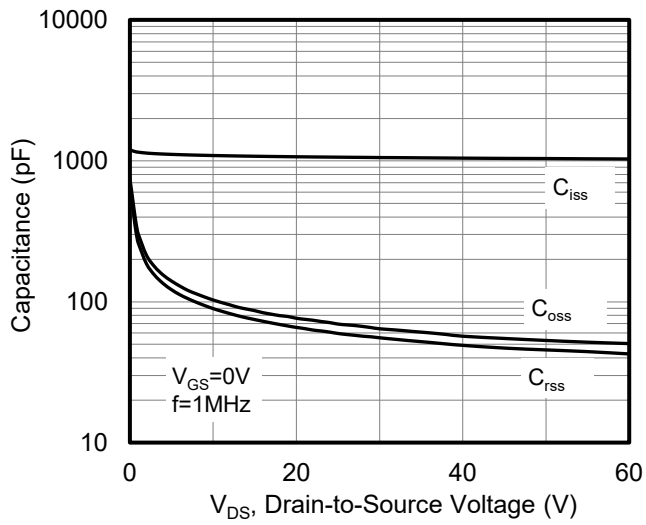

Figure 12. Capacitance Characteristics

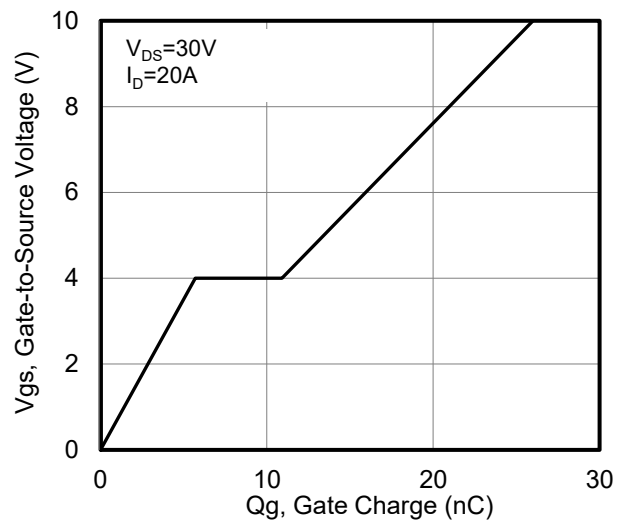
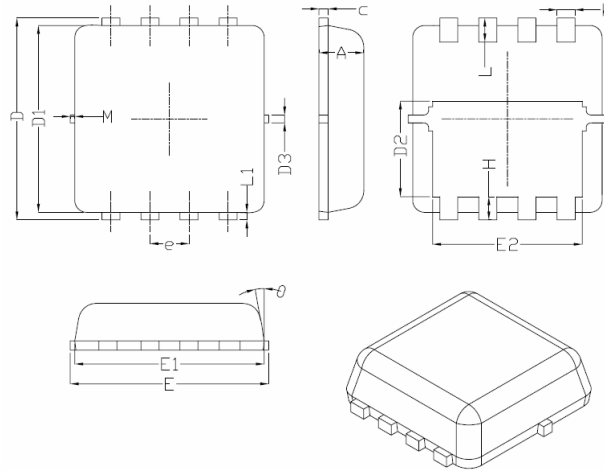

Figure 13. Typical Gate Charge vs. Gate to Source Voltage



### DFN3X3-8L Package Information



Symbol	Dimensions In Millimeters		
	Min.	Nom.	Max.
A	0.70	0.75	0.80
b	0.25	0.30	0.35
c	0.10	0.15	0.25
D	3.25	3.35	3.45
D1	3.00	3.10	3.20
D2	1.48	1.58	1.68
D3	-	0.13	-
E	3.20	3.30	3.40
E1	3.00	3.15	3.20
E2	2.39	2.49	2.59
e	0.65BSC		
H	0.30	0.39	0.50
L	0.30	0.40	0.50
L1	-	0.13	-
M	*	*	0.15
$\theta$		10°	12°



### Attention

- Any and all HUA XUAN YANG ELECTRONICS products described or contained herein do not have specifications that can handle applications that require extremely high levels of reliability, such as life-support systems, aircraft's control systems, or other applications whose failure can be reasonably expected to result in serious physical and/or material damage. Consult with your HUA XUAN YANG ELECTRONICS representative nearest you before using any HUA XUAN YANG ELECTRONICS products described or contained herein in such applications.
- HUA XUAN YANG ELECTRONICS assumes no responsibility for equipment failures that result from using products at values that exceed, even momentarily, rated values (such as maximum ratings, operating condition ranges, or other parameters) listed in products specifications of any and all HUA XUAN YANG ELECTRONICS products described or contained herein.
- Specifications of any and all HUA XUAN YANG ELECTRONICS products described or contained herein stipulate the performance, characteristics, and functions of the described products in the independent state, and are not guarantees of the performance, characteristics, and functions of the described products as mounted in the customer's products or equipment. To verify symptoms and states that cannot be evaluated in an independent device, the customer should always evaluate and test devices mounted in the customer's products or equipment.
- HUA XUAN YANG ELECTRONICS CO.,LTD. strives to supply high-quality high-reliability products. However, any and all semiconductor products fail with some probability. It is possible that these probabilistic failures could give rise to accidents or events that could endanger human lives, that could give rise to smoke or fire, or that could cause damage to other property. When designing equipment, adopt safety measures so that these kinds of accidents or events cannot occur. Such measures include but are not limited to protective circuits and error prevention circuits for safe design, redundant design, and structural design.
- In the event that any or all HUA XUAN YANG ELECTRONICS products(including technical data, services) described or contained herein are controlled under any of applicable local export control laws and regulations, such products must not be exported without obtaining the export license from the authorities concerned in accordance with the above law.
- No part of this publication may be reproduced or transmitted in any form or by any means, electronic or mechanical, including photocopying and recording, or any information storage or retrieval system, or otherwise, without the prior written permission of HUA XUAN YANG ELECTRONICS CO.,LTD.
- Information (including circuit diagrams and circuit parameters) herein is for example only ; it is not guaranteed for volume production. HUA XUAN YANG ELECTRONICS believes information herein is accurate and reliable, but no guarantees are made or implied regarding its use or any infringements of intellectual property rights or other rights of third parties.
- Any and all information described or contained herein are subject to change without notice due to product/technology improvement, etc. When designing equipment, refer to the "Delivery Specification" for the HUA XUAN YANG ELECTRONICS product that you intend to use.