



General Description

The IPD16CN10NG use advanced SGT MOSFET technology to provide low RDS(ON), low gate charge, fast switching and excellent avalanche characteristics. This device is specially designed to get better ruggedness.



General Features

$V_{DS} = 100V$ $I_D = 60A$
 $R_{DS(ON)} < 17m\Omega @ V_{GS} = 10V$

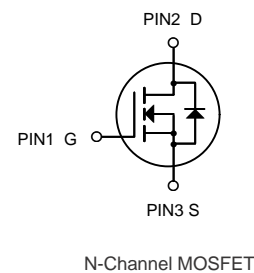

Applications

Consumer electronic power supply Motor control
Synchronous-rectification Isolated DC
Synchronous-rectification applications

Ordering Information

Product ID	Pack	Brand	Qty(PCS)
IPD16CN10NG	TO252-2L	HXY MOSFET	2500

Absolute Maximum Ratings at $T_j = 25^\circ C$ unless otherwise noted

Parameter	Symbol	Value	Unit
Drain source voltage	V _{DS}	100	V
Gate source voltage	V _{GS}	±20	V
Continuous drain current ¹⁾	I _D	60	A
Pulsed drain current ²⁾	I _{D, pulse}	180	A
Power dissipation ³⁾	P _D	67.5	W
Single pulsed avalanche energy ⁵⁾	E _{AS}	80	mJ
Operation and storage temperature	T _{stg} , T _j	-55 to 150	°C
Thermal resistance, junction-case	R _{θJC}	1.85	°C/W
Thermal Resistance Junction-Ambient ¹	R _{θJA}	45	°C/W



Electrical Characteristics (T_J= 25°C, unless otherwise noted)

Parameter	Symbol	Test Conditions	Min.	Typ.	Max.	Unit	
Static Characteristics							
Drain-Source Breakdown Voltage	V _{(BR)DSS}	V _{GS} = 0V, I _D = 250μA	100	-	-	V	
Gate-Body Leakage Current	I _{GSS}	V _{DS} = 0V, V _{GS} = ±20V	-	-	±100	nA	
Zero Gate Voltage Drain Current	I _{DSS}	V _{DS} = 100V, V _{GS} = 0V	T _J =25°C	-	-	1	μA
			T _J =100°C	-	-	100	
Gate-Threshold Voltage	V _{GS(th)}	V _{DS} = V _{GS} , I _D = 250μA	1	1.7	2.5	V	
Drain-Source on-Resistance ⁴	R _{DS(on)}	V _{GS} = 10V, I _D = 20A	-	13.5	17	mΩ	
		V _{GS} = 4.5V, I _D = 10A	-	17	20		
Forward Transconductance ⁴	g _{fs}	V _{DS} = 10V, I _D = 20A	-	54	-	S	
Dynamic Characteristics⁵							
Input Capacitance	C _{iss}	V _{DS} = 50V, V _{GS} = 0V, f = 1MHz	-	1208	-	pF	
Output Capacitance	C _{oss}		-	144	-		
Reverse Transfer Capacitance	C _{rss}		-	11.3	-		
Gate Resistance	R _G	f = 1MHz	-	1.8	-	Ω	
Switching Characteristics⁵							
Total Gate Charge	Q _g	V _{GS} = 10V, V _{DS} = 50V, I _D = 20A	-	22.7	-	nC	
Gate-Source Charge	Q _{gs}		-	3	-		
Gate-Drain Charge	Q _{gd}		-	5	-		
Turn-on Delay Time	t _{d(on)}	V _{GS} = 10V, V _{DD} = 50V, R _G = 3Ω, I _D = 20A	-	9.2	-	ns	
Rise Time	t _r		-	3.6	-		
Turn-off Delay Time	t _{d(off)}		-	25.6	-		
Fall Time	t _f		-	4.4	-		
Body Diode Reverse Recovery Time	t _{rr}	I _F = 20A, dI/dt = 100A/μs	-	30	-	ns	
Body Diode Reverse Recovery Charge	Q _{rr}		-	42	-	nC	
Drain-Source Body Diode Characteristics							
Diode Forward Voltage ⁴	V _{SD}	I _S = 20A, V _{GS} = 0V	-	-	1.2	V	
Continuous Source Current	I _S	T _C =25°C	-	-	60	A	

Notes:

1. Repetitive rating, pulse width limited by junction temperature T_{J(MAX)}=150°C.
2. The EAS data shows Max. rating . The test condition is V_{DD}=25V, V_{GS}=10V, L=0.4mH, I_{AS}=20A.
3. The data tested by surface mounted on a 1 inch² FR-4 board with 2OZ copper, The value in any given application depends on the user's specific board design.
4. The data tested by pulsed , pulse width ≤ 300us , duty cycle ≤ 2%.
5. This value is guaranteed by design hence it is not included in the production test..



Typical Characteristics

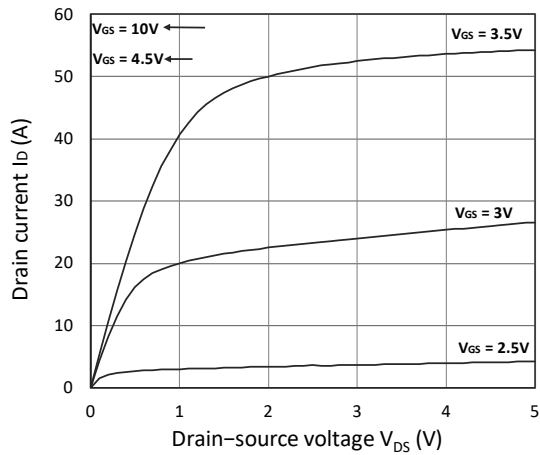

Figure 1. Output Characteristics

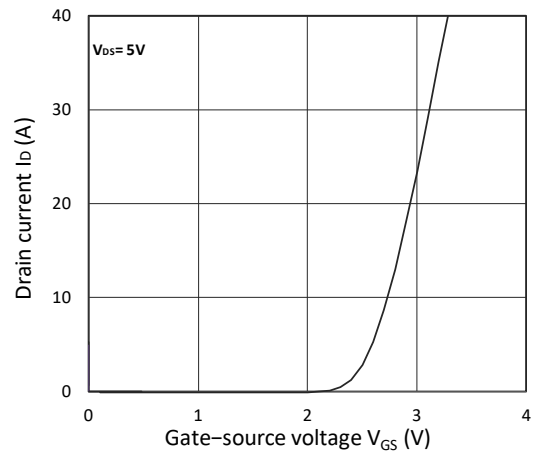

Figure 2. Transfer Characteristics

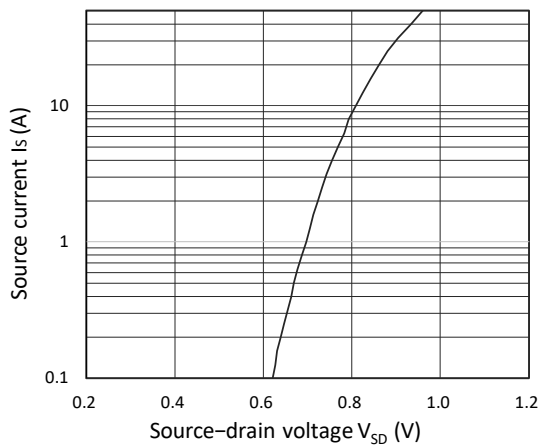

Figure 3. Forward Characteristics of Reverse

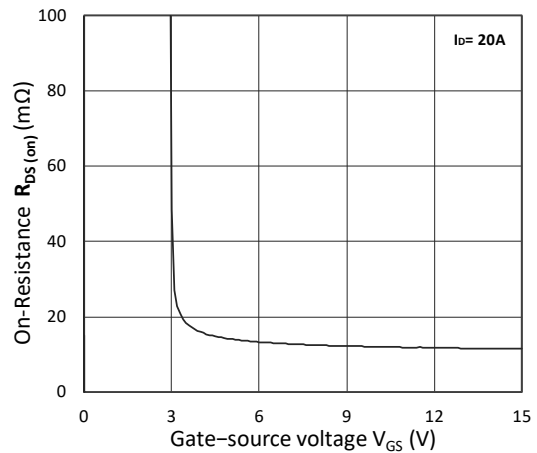

Figure 4. $R_{DS(ON)}$ vs. V_{GS}

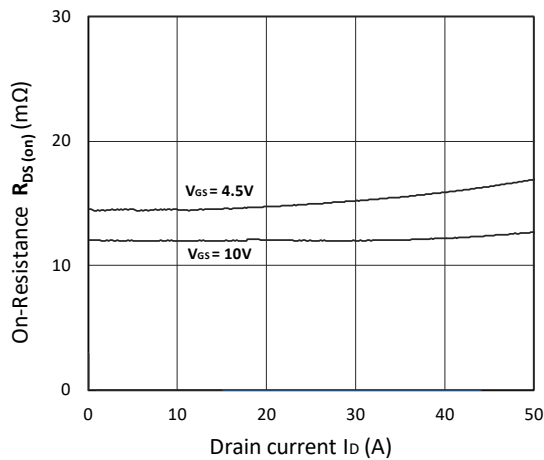

Figure 5. $R_{DS(ON)}$ vs. I_D

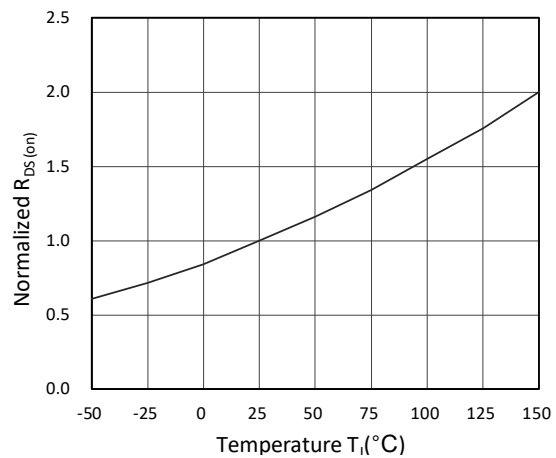

Figure 6. Normalized $R_{DS(on)}$ vs. Temperature

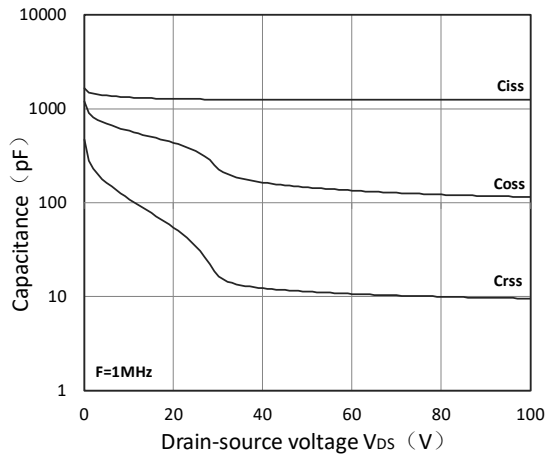

Figure 7. Capacitance Characteristics

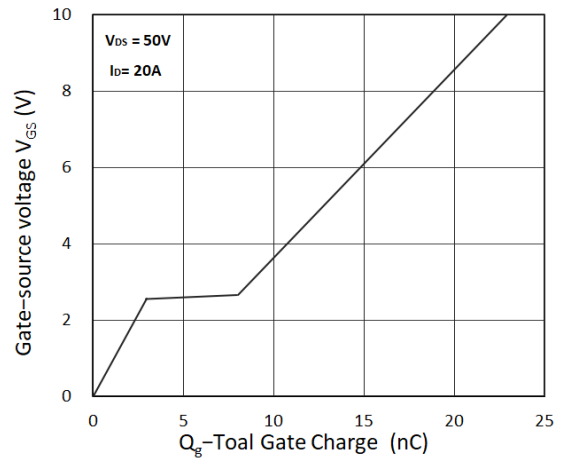

Figure 8. Gate Charge Characteristics

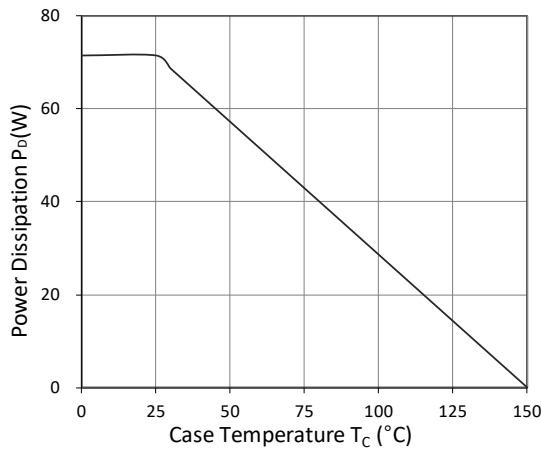

Figure 9. Power Dissipation

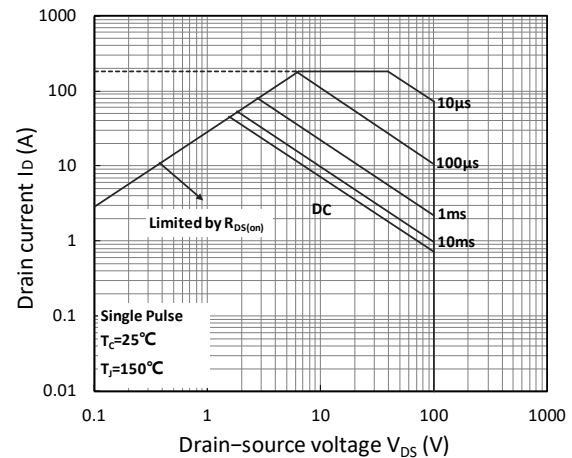

Figure 10. Safe Operating Area

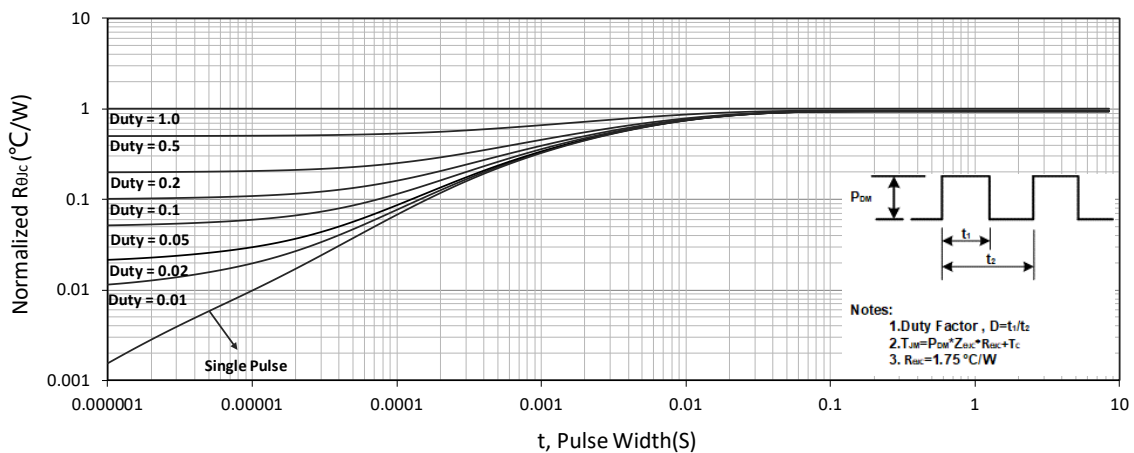

Figure 11. Normalized Maximum Transient Thermal Impedance



Test Circuit

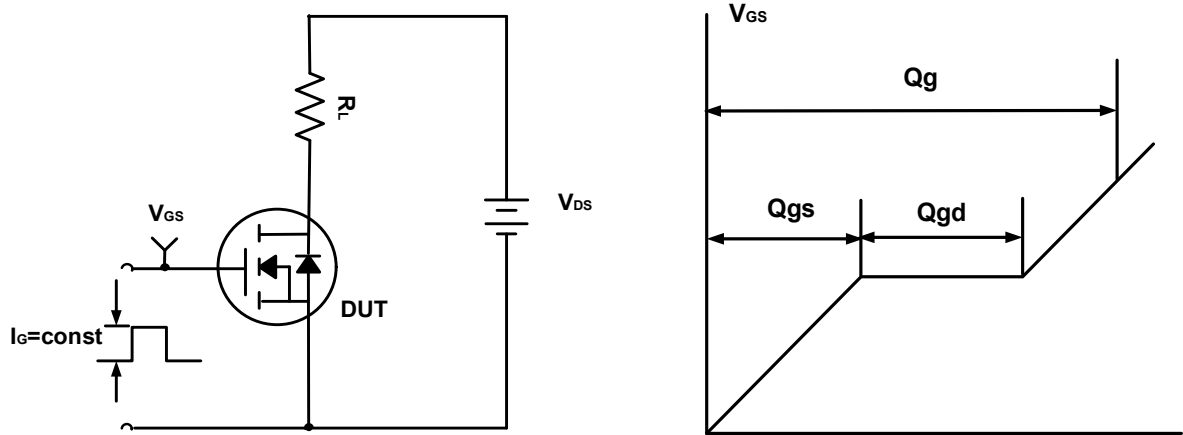

Figure A. Gate Charge Test Circuit & Waveforms

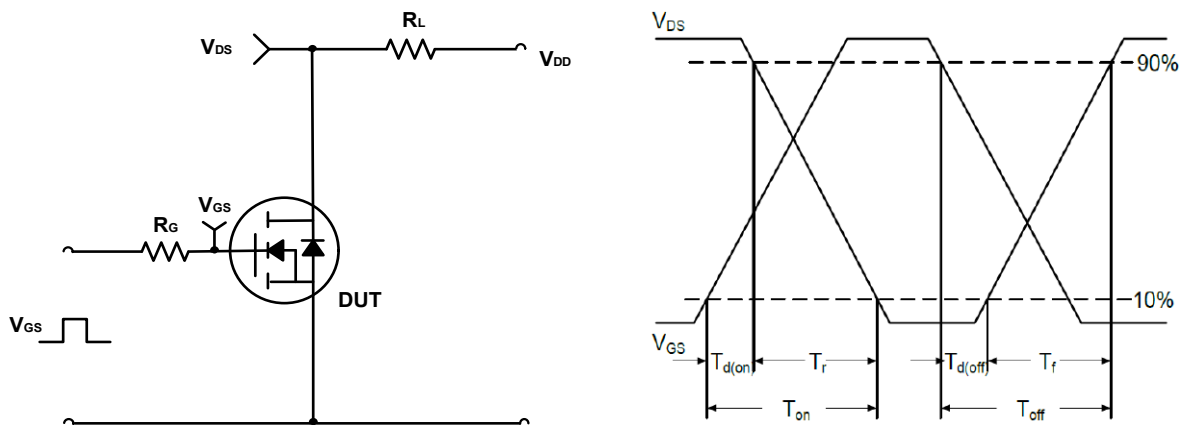

Figure B. Switching Test Circuit & Waveforms

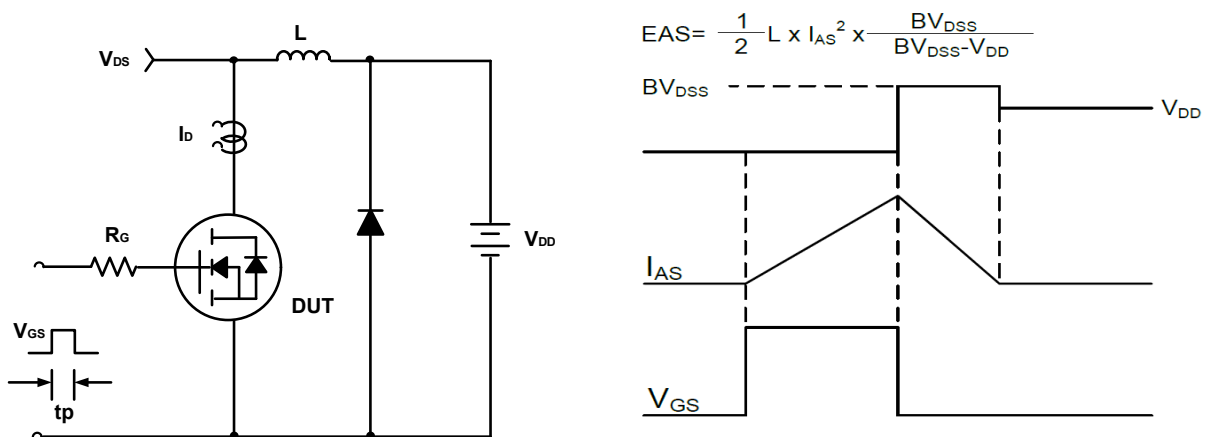
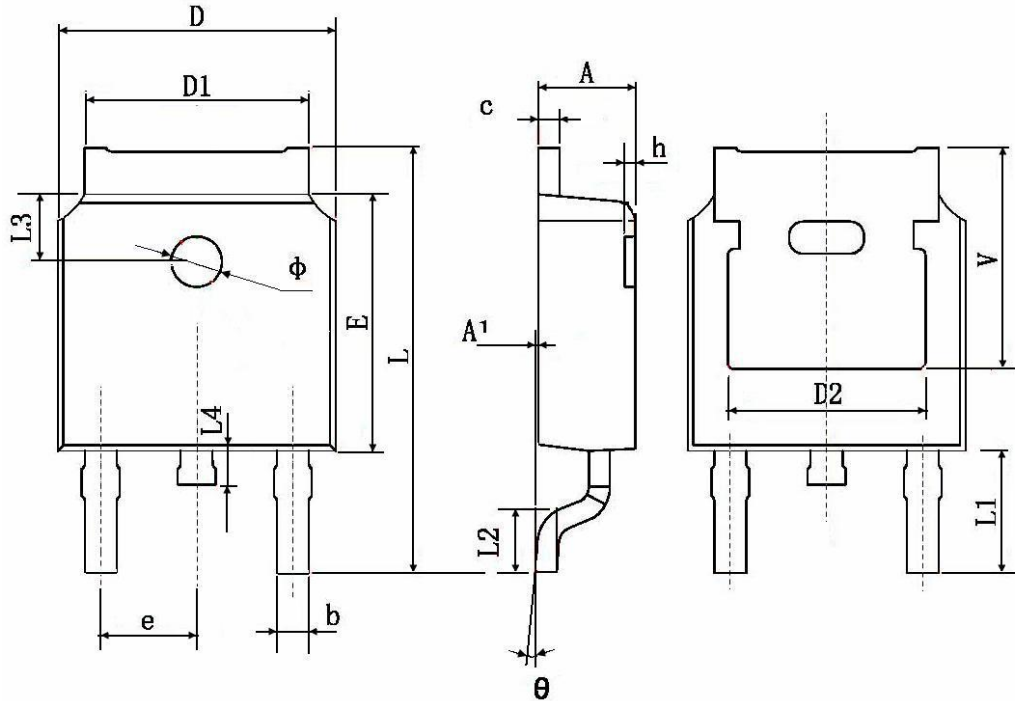

Figure C. Unclamped Inductive Switching Circuit & Waveforms



TO252-2L Package Information



Symbol	Dimensions In Millimeters		Dimensions In Inches	
	Min.	Max.	Min.	Max.
A	2.200	2.400	0.087	0.094
A1	0.000	0.127	0.000	0.005
b	0.660	0.860	0.026	0.034
c	0.460	0.580	0.018	0.023
D	6.500	6.700	0.256	0.264
D1	5.100	5.460	0.201	0.215
D2	0.483 TYP.		0.190 TYP.	
E	6.000	6.200	0.236	0.244
e	2.186	2.386	0.086	0.094
L	9.800	10.400	0.386	0.409
L1	2.900 TYP.		0.114 TYP.	
L2	1.400	1.700	0.055	0.067
L3	1.600 TYP.		0.063 TYP.	
L4	0.600	1.000	0.024	0.039
φ	1.100	1.300	0.043	0.051
θ	0°	8°	0°	8°
h	0.000	0.300	0.000	0.012
V	5.350 TYP.		0.211 TYP.	



Attention

- Any and all HUA XUAN YANG ELECTRONICS products described or contained herein do not have specifications that can handle applications that require extremely high levels of reliability, such as life-support systems, aircraft's control systems, or other applications whose failure can be reasonably expected to result in serious physical and/or material damage. Consult with your HUA XUAN YANG ELECTRONICS representative nearest you before using any HUA XUAN YANG ELECTRONICS products described or contained herein in such applications.
- HUA XUAN YANG ELECTRONICS assumes no responsibility for equipment failures that result from using products at values that exceed, even momentarily, rated values (such as maximum ratings, operating condition ranges, or other parameters) listed in products specifications of any and all HUA XUAN YANG ELECTRONICS products described or contained herein.
- Specifications of any and all HUA XUAN YANG ELECTRONICS products described or contained herein stipulate the performance, characteristics, and functions of the described products in the independent state, and are not guarantees of the performance, characteristics, and functions of the described products as mounted in the customer's products or equipment. To verify symptoms and states that cannot be evaluated in an independent device, the customer should always evaluate and test devices mounted in the customer's products or equipment.
- HUA XUAN YANG ELECTRONICS CO.,LTD. strives to supply high-quality high-reliability products. However, any and all semiconductor products fail with some probability. It is possible that these probabilistic failures could give rise to accidents or events that could endanger human lives, that could give rise to smoke or fire, or that could cause damage to other property. When designing equipment, adopt safety measures so that these kinds of accidents or events cannot occur. Such measures include but are not limited to protective circuits and error prevention circuits for safe design, redundant design, and structural design.
- In the event that any or all HUA XUAN YANG ELECTRONICS products(including technical data, services) described or contained herein are controlled under any of applicable local export control laws and regulations, such products must not be exported without obtaining the export license from the authorities concerned in accordance with the above law.
- No part of this publication may be reproduced or transmitted in any form or by any means, electronic or mechanical, including photocopying and recording, or any information storage or retrieval system, or otherwise, without the prior written permission of HUA XUAN YANG ELECTRONICS CO.,LTD.
- Information (including circuit diagrams and circuit parameters) herein is for example only ; it is not guaranteed for volume production. HUA XUAN YANG ELECTRONICS believes information herein is accurate and reliable, but no guarantees are made or implied regarding its use or any infringements of intellectual property rights or other rights of third parties.
- Any and all information described or contained herein are subject to change without notice due to product/technology improvement, etc. When designing equipment, refer to the "Delivery Specification" for the HUA XUAN YANG ELECTRONICS product that you intend to use.