

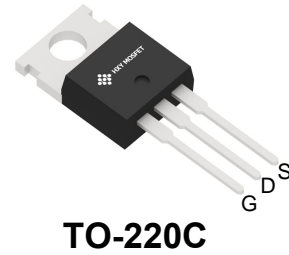

Description

The IXTP5N50P can be used in various power switching circuit for system miniaturization and higher efficiency. The package form is TO-220C, which accords with the RoHS standard.



General Features

$V_{DS} = 500V, I_D = 4.5A$
 $R_{DS(ON)} < 1.5\Omega @ V_{GS}=10V$

Application

- Power switch circuit of adaptor and charger.

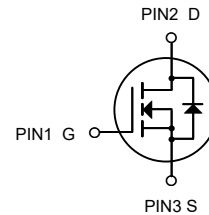

N-Channel MOSFET

Ordering Information

Product ID	Pack	Brand	Units Tube
IXTP5N50P	TO-220C	HXY MOSFET	50

Absolute Maximum Ratings@T=25°C (unless otherwise specified)

Symbol	Parameter	Limit	Unit
V_{DSS}	Drain-to-Source Voltage	500	V
V_{GSS}	Gate-to-Source Voltage	± 30	
I_D	Continuous Drain Current ^[1]	4.5	A
$I_D @ T_c=100^\circ C$	Continuous Drain Current @ $T_c=100^\circ C$	2.6	
I_{DM}	Pulsed Drain Current at $V_{GS}=10V^{[1][2]}$	16	
E_{AS}	Single Pulse Avalanche Energy ^[3]	315	mJ
P_D	Power Dissipation ^[1]	139	W
$T_J \& T_{STG}$	Operating and Storage Temperature Range	-55 to 150	°C
$R_{\theta JC}$	Thermal Resistance, Junction-to-Case ^[1]	0.9	°C/W
$R_{\theta JA}$	Thermal Resistance, Junction-to-Ambient ^[6]	77	



Electrical Characteristics $T_J=25^{\circ}\text{C}$ unless otherwise specified

Parameter	Symbol	Test Condition	Min	Typ	Max	Unit	
Off characteristics							
Drain-source breakdown voltage	$V_{(BR)DSS}$	$V_{GS} = 0V, I_D = 1mA$	500	-	-	V	
Zero gate voltage drain current	I_{DSS}	$V_{DS}=500V, V_{GS}=0V$	$T_J=25^{\circ}\text{C}$	-	-	1.0	μA
			$T_J=125^{\circ}\text{C}$	-	-	100	
Gate-body leakage current	I_{GSS}	$V_{DS} = 0V, V_{GS} = \pm 30V$	-	-	± 100	nA	
On characteristics ^[4]							
Gate-threshold voltage	$V_{GS(th)}$	$V_{DS} = V_{GS}, I_D = 250\mu\text{A}$	2.0	3.0	4.0	V	
Static drain-source on-resistance	$R_{DS(on)}$	$V_{GS} = 10V, I_D = 2A$	-	1.2	1.5	Ω	
Dynamic characteristics ^[5]							
Input capacitance	C_{iss}	$V_{DS} = 50V, V_{GS} = 0V, f = 1\text{MHz}$	-	639	-	pF	
Output capacitance	C_{oss}		-	41	-		
Reverse transfer capacitance	C_{rss}		-	2	-		
Gate resistance	R_g	$f = 1\text{MHz}$	-	2.8	-	Ω	
Switching characteristics ^[5]							
Total gate charge	Q_g	$V_{DS} = 50V, V_{GS} = 10V, I_D = 4A$	-	10	-	nC	
Gate-source charge	Q_{gs}		-	3	-		
Gate-drain charge	Q_{gd}		-	2	-		
Turn-on delay time	$t_{d(on)}$	$V_{DD} = 250V, V_{GS} = 10V, R_G = 10\Omega, I_D = 10A$	-	7	-	ns	
Turn-on rise time	t_r		-	5	-		
Turn-off delay time	$t_{d(off)}$		-	13	-		
Turn-off fall time	t_f		-	5	-		
Drain-Source Diode Characteristics							
Drain-source diode forward voltage ^[4]	V_{SD}	$V_{GS} = 0V, I_S = 4A$	-	-	1.2	V	
Maximum continuous drain-source diode forward current ^[1]	I_S		-	-	4	A	
Maximum pulsed drain-source diode forward current ^{[1][2]}	I_{SM}		-	-	16	A	
Reverse recovery time	t_{rr}	$dI/dt = 100A/\mu\text{s}, I_S = 10A, V_{DD} = 50V$	-	196	-	ns	
Reverse recovery charge	Q_{rr}		-	1131	-	nC	

Notes :

- $T_C=25^{\circ}\text{C}$ Limited only by maximum temperature allowed.
- $P_W \leq 10\mu\text{s}$, Duty cycle $\leq 1\%$.
- EAS condition: $V_{DD}=50V, V_{GS}=10V, L=10\text{mH}, R_g=25\Omega$, Starting $T_J = 25^{\circ}\text{C}$.
- Pulse Test : Pulse Width $\leq 300\mu\text{s}$, duty cycle $\leq 2\%$.
- Guaranteed by design, not subject to production.
- The value of $R_{\theta JA}$ is measured with the device in a still air environment with $T_a=25^{\circ}\text{C}$.



Typical Characteristics

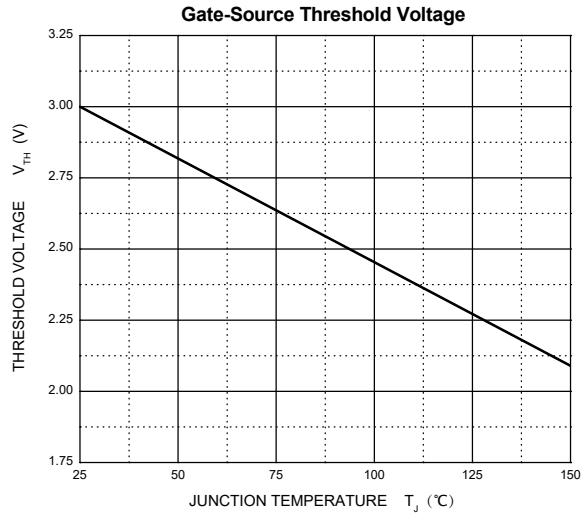
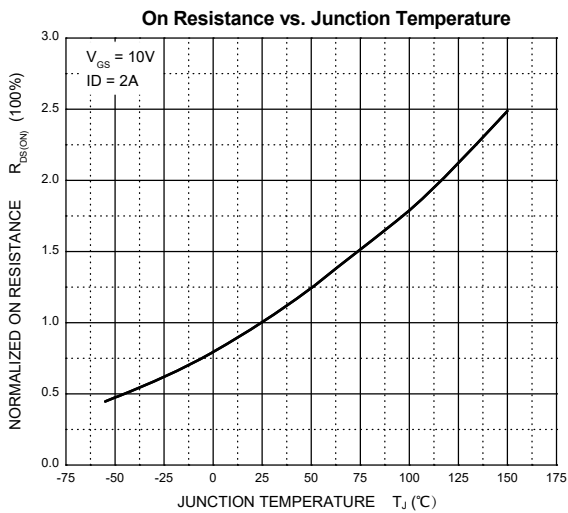
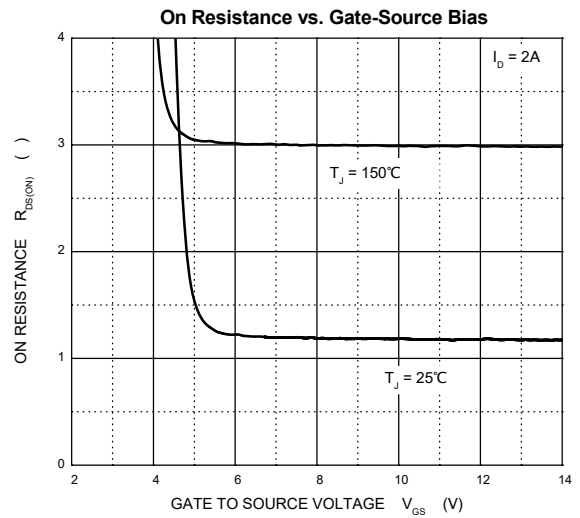
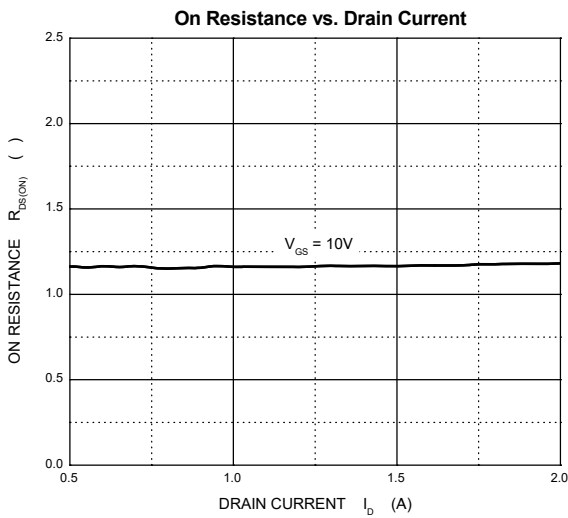
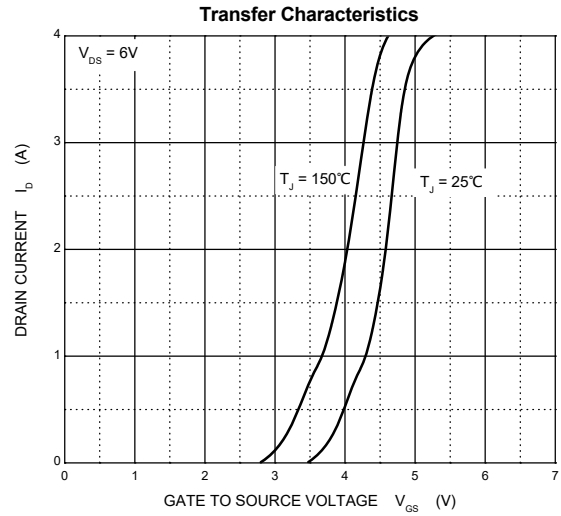
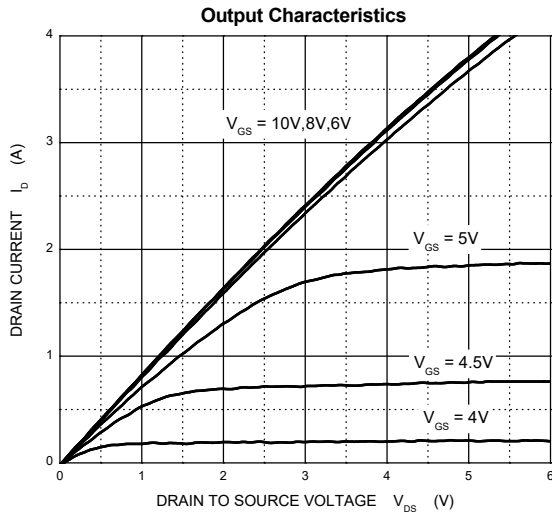



Typical Capacitances

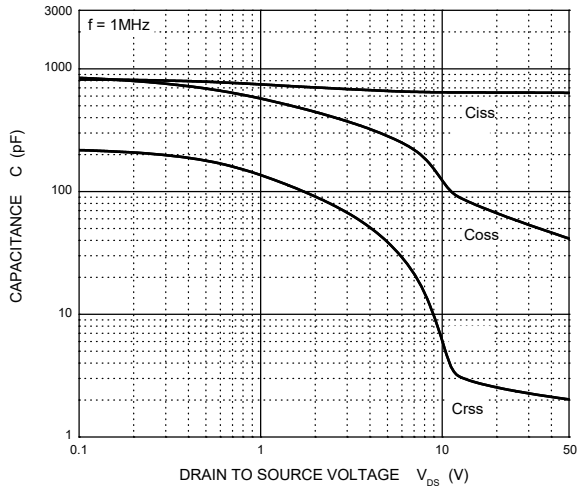

Gate Charge

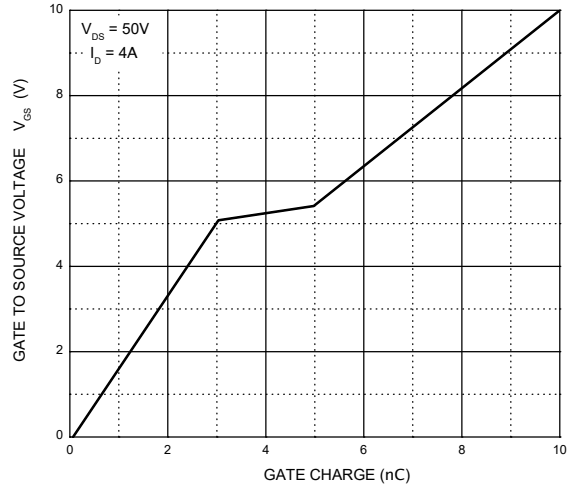

Source-Drain Diode Forward Characteristics

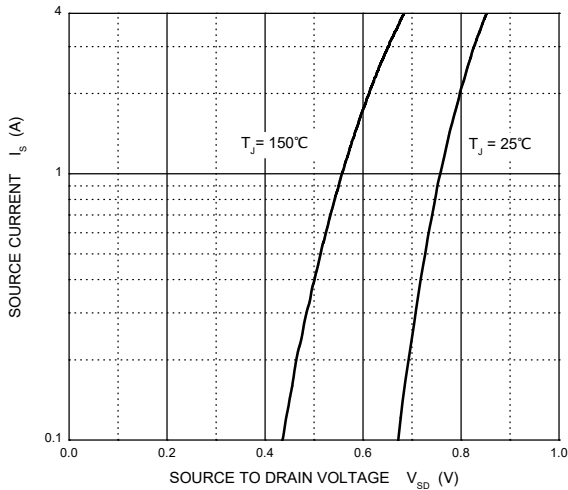

Maximum Safe Operating Area

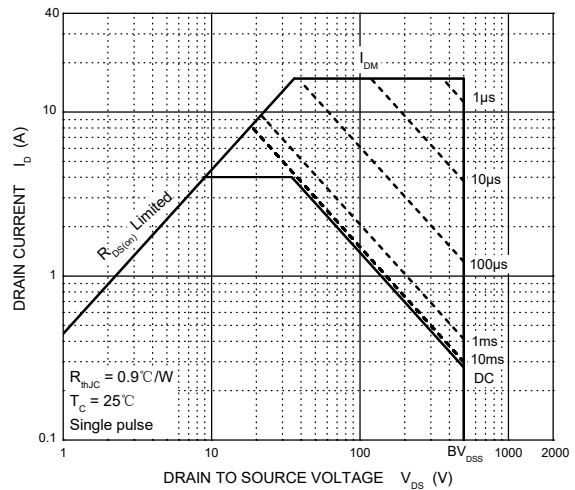

Transient Thermal Impedance, Junction-Case

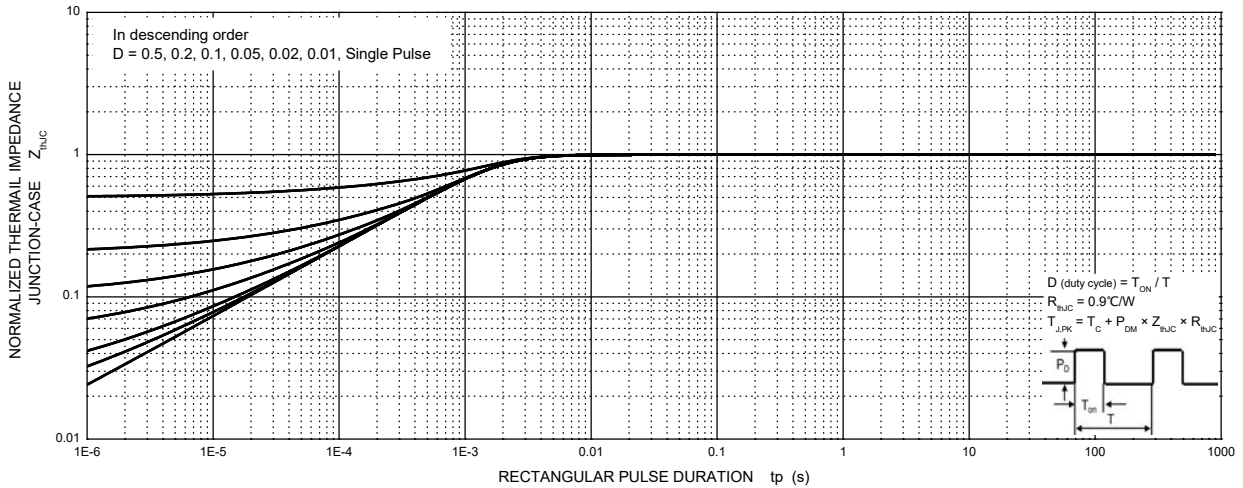



Package Information
TO-220C

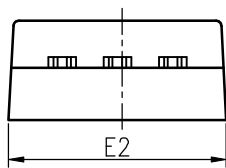
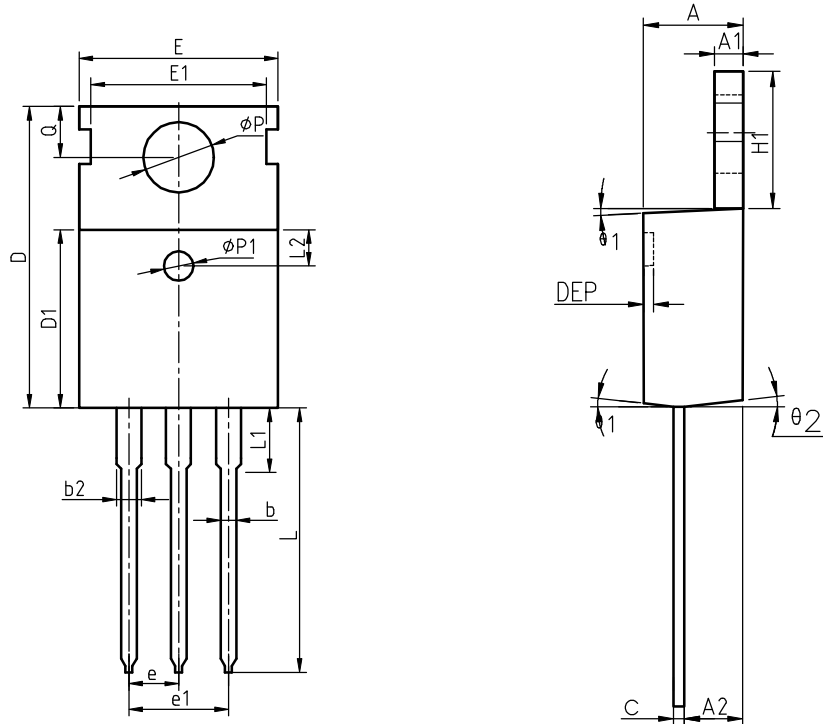

COMMON DIMENSIONS

SYMBOL	MIN	NOM	MAX	MIN	NOM	MAX
A	4.40	4.57	4.70	0.173	0.180	0.185
A1	1.27	1.30	1.33	0.050	0.051	0.052
A2	2.35	2.40	2.50	0.093	0.094	0.098
b	0.77	0.80	0.90	0.030	0.031	0.035
b2	1.17	1.27	1.36	0.046	0.050	0.054
c	0.48	0.50	0.56	0.019	0.020	0.022
D	15.40	15.60	15.80	0.606	0.614	0.622
D1	9.00	9.10	9.20	0.354	0.358	0.362
DEP	0.05	0.10	0.20	0.002	0.004	0.008
E	9.80	10.00	10.20	0.386	0.394	0.402
E1	-	8.70	-	-	0.343	-
E2	9.80	10.00	10.20	0.386	0.394	0.402
e		2.54	BSC		0.100	BSC
e1		5.08	BSC		0.200	BSC
H1	6.40	6.50	6.60	0.252	0.256	0.260
L	12.75	13.50	13.65	0.502	0.531	0.537
L1	-	3.10	3.30	-	0.122	0.130
L2		2.50	REF		0.098	REF
P	3.50	3.60	3.63	0.138	0.142	0.143
P1	3.50	3.60	3.63	0.138	0.142	0.143
Q	2.73	2.80	2.87	0.107	0.110	0.113
theta 1	5°	7°	9°	5°	7°	9°
theta 2	1°	3°	5°	1°	3°	5°
theta 3	1°	3°	5°	1°	3°	5°



Attention

- Any and all HUA XUAN YANG ELECTRONICS products described or contained herein do not have specifications that can handle applications that require extremely high levels of reliability, such as life-support systems, aircraft's control systems, or other applications whose failure can be reasonably expected to result in serious physical and/or material damage. Consult with your HUA XUAN YANG ELECTRONICS representative nearest you before using any HUA XUAN YANG ELECTRONICS products described or contained herein in such applications.
- HUA XUAN YANG ELECTRONICS assumes no responsibility for equipment failures that result from using products at values that exceed, even momentarily, rated values (such as maximum ratings, operating condition ranges, or other parameters) listed in products specifications of any and all HUA XUAN YANG ELECTRONICS products described or contained herein.
- Specifications of any and all HUA XUAN YANG ELECTRONICS products described or contained herein stipulate the performance, characteristics, and functions of the described products in the independent state, and are not guarantees of the performance, characteristics, and functions of the described products as mounted in the customer's products or equipment. To verify symptoms and states that cannot be evaluated in an independent device, the customer should always evaluate and test devices mounted in the customer's products or equipment.
- HUA XUAN YANG ELECTRONICS CO.,LTD. strives to supply high-quality high-reliability products. However, any and all semiconductor products fail with some probability. It is possible that these probabilistic failures could give rise to accidents or events that could endanger human lives, that could give rise to smoke or fire, or that could cause damage to other property. When designing equipment, adopt safety measures so that these kinds of accidents or events cannot occur. Such measures include but are not limited to protective circuits and error prevention circuits for safe design, redundant design, and structural design.
- In the event that any or all HUA XUAN YANG ELECTRONICS products(including technical data, services) described or contained herein are controlled under any of applicable local export control laws and regulations, such products must not be exported without obtaining the export license from the authorities concerned in accordance with the above law.
- No part of this publication may be reproduced or transmitted in any form or by any means, electronic or mechanical, including photocopying and recording, or any information storage or retrieval system, or otherwise, without the prior written permission of HUA XUAN YANG ELECTRONICS CO.,LTD.
- Information (including circuit diagrams and circuit parameters) herein is for example only ; it is not guaranteed for volume production. HUA XUAN YANG ELECTRONICS believes information herein is accurate and reliable, but no guarantees are made or implied regarding its use or any infringements of intellectual property rights or other rights of third parties.
- Any and all information described or contained herein are subject to change without notice due to product/technology improvement, etc. When designing equipment, refer to the "Delivery Specification" for the HUA XUAN YANG ELECTRONICS product that you intend to use.