

# 深圳扬兴科技有限公司

## 产 品 规 格 书

### SPECIFICATION

产品名称	石英晶体振荡器 QUARTZ CRYSTAL OSCILLATOR
产品系列	YSO230LR
料 号	OB2-WDQYLF112-100M
参数描述	SMD-3225-100MHZ-2.5V-3.3V- FS±50PPM- LVDS
页 次	共5页

### 确 认 签 章

客 户		
客户物料号		
机种/型号		
批 准	审 核	检 验

### 扬 兴 签 核

制 定	审 核	批 准
陈 幸		

深圳扬兴科技有限公司

Shenzhen YangXing Technology Co., Ltd.

地址：深圳市龙华区民治街道民塘路385号汇德大厦1号楼19层

ADDRESS: 19th Floor, 1st Huide Building, Mintang Rd No.385, Longhua District, Shenzhen

TEL: 0755-28444777

WEB: <http://www.yxc.hk>



MHz Range Crystal Unit

YSO230LR

Product Name 系列型号

YSO230LR 100.00000MHz 2.5V~3.3V FS±50PPM

Product Number / Ordering Code 产品料号

OB2-WDQYLF112-100M

### 1.Specifications (电气参数)

Item/Type	LVDS	Remarks
Output Frequency Range	100MHZ	
Supply Voltage	2.5~ 3.3 Vdc ± 10%	
Operating Temperature Range	-40~+105°C	
Storage Temperature Range	-55~+125°C	
Total Stability	±50ppm	
Current Consumption	40mA Max	OE=Vcc,LVDS=(100)Ω
Output Voltage (LVDS)	VOH=1.6V Max	DC characteristics
	VOL=0.9V Min	
Output Load Condition	L_LVDS=100Ω	Connected between OUT to OUT
Input Voltage	VIH=70% VccMin, VIL=30%Vcc Max	OE terminal
Output Symmetry	45~55%	
Rise Time/Fall Time	0.8nS Max	LVDS:Between 20% and 80% Differential Output peak to peak voltage.
Start-up time	10mS	Time at minimum supply voltage to be 0 s
Aging	±3ppm	25°CFirst year, Vcc=2.5V,3.3V
Phase Jitter(12KHZ~20MHZ)	0.3ps Typ.	

### 2.External dimensions (外观尺寸) (Unit: mm)

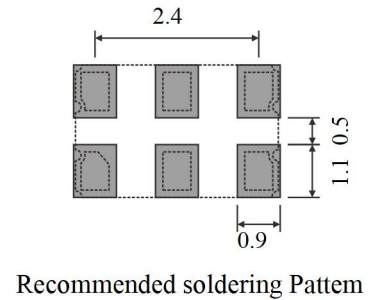
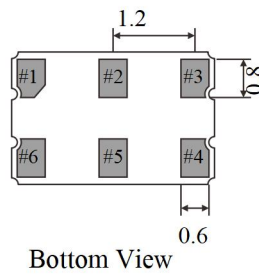
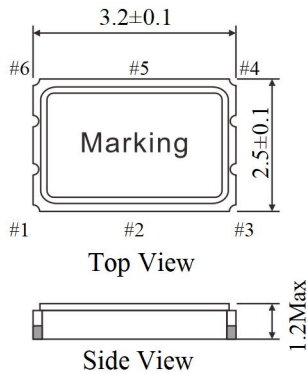

PAD	#1	#2	#3	#4	#5	#6
FUNCTION	OE	NC	GND	OUT+	OUT-	VDD

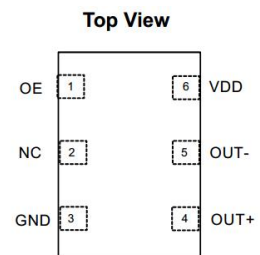
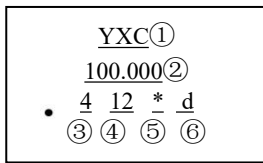

Figure 1. Pin Assignments

**Notes:**

1. To maintain stable operation provide a 0.01uF to 0.1uF by-pass capacitor at a location as near as possible to the power source terminal of the crystal product (between Vcc-GND)

### 3. Marking information (丝印说明)



- ① YangXing LOGO
- ② Frequency
- ③ Year
- ④ The production cycle
- ⑤ Line
- ⑥ Voltage+Operating Temperature

### 4. Taping Specification (载带规格) (Unit: mm)

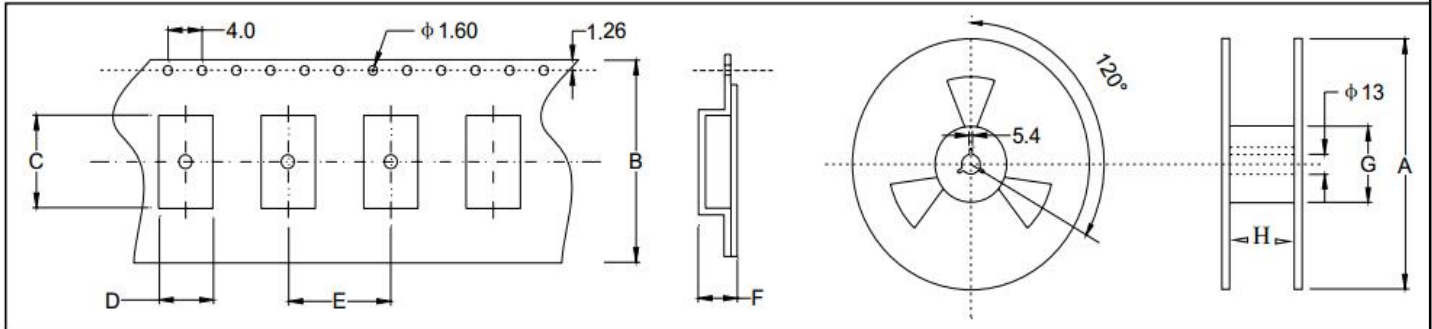

Size	A	B	C	D	E	F	G	H
SMD-3225	180±2.0	8.0±0.3	3.40±0.1	2.70±0.1	4.0±0.1	1.40±0.1	61.0±1.0	9.5±0.5

3000 pcs per reel

### 5. Reflow profile (回流焊)

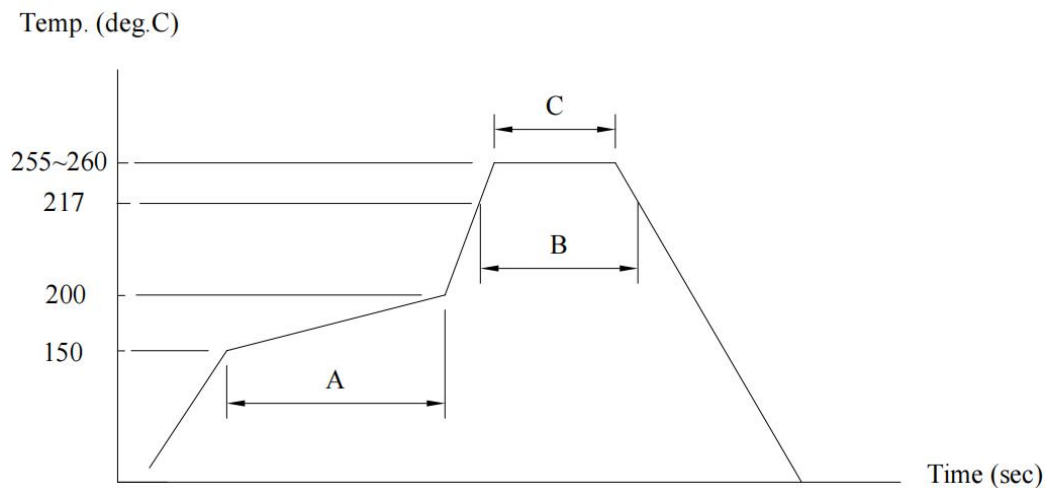

- (A)→Preheating area : 150~200°C, 60~120sec.
- (B)→Heating area : 217°C, 60~150sec.
- (C)→Peak temperature : 255~260°C, 30sec. Max.
- Ramp-up rate (217→260°C) : 3°C/sec. Max.
- Ramp-down rate (260→217°C) : 6°C/sec. Max.
- Time 25°C→260°C : 480sec. Max.
- Moisture Sensitivity Level : Level1

## 6. Notice (注意)

### 包装 PACKING

包装方式应符合运输和装卸要求，特殊包装须经双方认可。

Packing must prevent damage during transportation and handing. Specific method will be settled by mutual Agreement.

### 对环境影响 INFLUENCE TO ENVIRONMENT

本产品在生产过程中不使用 ODS I，对臭氧层无破坏。

This product doesn't use the class I ODS at any of production process.

### 生产厂家 MANUFACTURER

公司名称：深圳扬兴科技有限公司

Shenzhen YangXing Technology Co., Ltd.

### 其它 OTHERS

1.如果您对本公司产品规格书有疑问或书中未列出，请与我方联系，协商解决及改进。

If you have some doubt or unknowing about this specification, Please contact us for settlement or development.

2.我们按照产品规格书要求保证晶体品质，若客户要求具体数据，我们可提供。

We guarantee that quartz crystal unit satisfies this specification, If you need the data, we will provide it.

3.如需应用于超声波环境下，请与我们联系。

For application in ultrasonic environment, please contact us.

4.在电路设计中，不要将晶振设计在电路板边缘。

In the circuit design, do not layout the crystal at the PCB edge.

5.变更与联络 (MODIFY AND CONTACT)

本产品在设计、工艺、材料、生产厂所、关键设备、操作人员等影响产品质量的因素有变更时，应事先提供更改后的产品并经过质量认可后，方可大批量供货。

When the quality is changed due to the changes of the design, technology, material, manufacture place, main equipment and workers, we will first supply the modified products and obtain approval from you, then start to supply mass production.

6.售前售后服务 (AFTER SALE SERVICE)

若在生产过程中遇到不良品，本公司负责调换，并及时提交不良品的分析及改进措施报告经认可。

If the defection product was found in the production process, we will exchange and provide the improving measures in time.

**此规格书仅供参考。若有需要，请与我方索要正式承认书作为物料承认及质量判定依据。**

This specification is for reference only. If needed, please request a formal letter of acknowledgment from our side to serve as the basis for material acknowledgment and quality judgment.

## 7. Contact us (联系我们)

[www.yxc.hk](http://www.yxc.hk)