



Description

The NTMS4917NR2G uses advanced trench technology to provide excellent $R_{DS(ON)}$, low gate charge and operation with gate voltages as low as 4.5V. This device is suitable for use as a Battery protection or in other Switching application.



SOP-8

General Features

$V_{DS} = 30V$ $I_D = 10A$

$R_{DS(ON)} < 12m\Omega$ @ $V_{GS}=10V$

Application

Battery protection

Load switch

Uninterruptible power supply

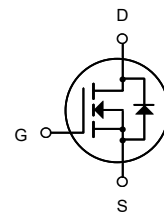

N-Channel MOSFET

Ordering Information

Product ID	Pack	Brand	Qty(PCS)
NTMS4917NR2G	SOP-8	HXY MOSFET	3000

Absolute Maximum Ratings (Tc=25°C unless otherwise noted)

Symbol	Parameter	Limit	Unit
V_{DS}	Drain-Source Voltage	30	V
V_{GS}	Gate-Source Voltage	± 20	V
I_D	Drain Current-Continuous	10.0	A
I_{DM}	Pulsed Drain Current	40	A
P_D	Maximum Power Dissipation	2.2	W
E_{AS}	Single pulse avalanche energy	17	mJ
T_J, T_{STG}	Operating Junction and Storage Temperature Range	-55 To 150	°C
$R_{\theta JA}$	Thermal Resistance, Junction-to-Case	57	°C/W



Electrical Characteristics (T_J=25 °C, unless otherwise noted)

Symbol	Parameter	Conditions	Min	Typ	Max	Units
BV_{DSS}	Drain-Source Breakdown Voltage	V _{GS} =0V, I _D =250μA	30	---	---	V
I_{DSS}	Zero Gate Voltage Drain Current	V _{GS} =0V, V _{DS} =30V	---	---	1	μA
I_{GSS}	Gate-Source Leakage Current	V _{GS} =±20V, V _{DS} =0A	---	---	±100	nA
V_{GS(th)}	Gate-Source Threshold Voltage	V _{GS} =V _{DS} , I _D =250μA	1	1.4	2.5	V
R_{DS(on)}	Drain-Source On Resistance	V _{GS} =10V, I _D =10A	---	9	12	mΩ
		V _{GS} =4.5V, I _D =5A	---	15	20	mΩ
C_{iss}	Input Capacitance	V _{DS} =15V, V _{GS} =0V, f=1MHz	---	580	---	pF
C_{oss}	Output Capacitance		---	110	---	
C_{rss}	Reverse Transfer Capacitance		---	94	---	
t_{d(on)}	Turn-On Delay Time	V _{DS} =30V, I _D =20A, R _G =3Ω, V _{GS} =10V	---	4	---	ns
t_r	Rise Time		---	7	---	ns
t_{d(off)}	Turn-Off Delay Time		---	20	---	ns
t_f	Fall Time		---	6	---	ns
Q_g	Total Gate Charge	V _{GS} =4.5V, V _{DS} =15V, I _D =10A	---	8	---	nC
Q_{gs}	Gate-Source Charge		---	4.6	---	nC
Q_{gd}	Gate-Drain "Miller" Charge		---	3.5	---	nC
I_S	Continuous Drain Current	V _D =V _G =0V	---	---	10	A
I_{SM}	Diode pulsed current	V _D =V _G =0V	---	---	40	A
V_{SD}	Source-Drain Diode Forward Voltage	V _{GS} =0V, I _S =10A	---	---	1.2	V
Q_{rr}	Reverse Recovery Charge	I _S =20A, di/dt=100A/us	---	5.9	---	nC
T_{rr}	Reverse Recovery Time		---	7	---	ns

Notes:

1. Repetitive Rating: Pulse Width Limited by Maximum Junction Temperature
2. EAS condition: T_J=25°C, V_{DD}=15V, V_G=10V, L=0.5mH
3. Pulse Test: Pulse Width≤300μs, Duty Cycle≤0.5%



Typical Characteristics

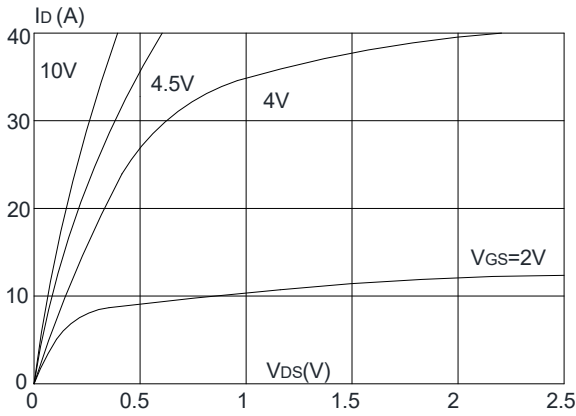

Figure 1: Output Characteristics

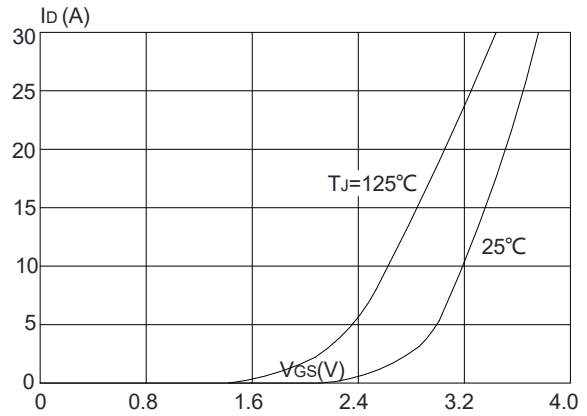

Figure 2: Typical Transfer Characteristics

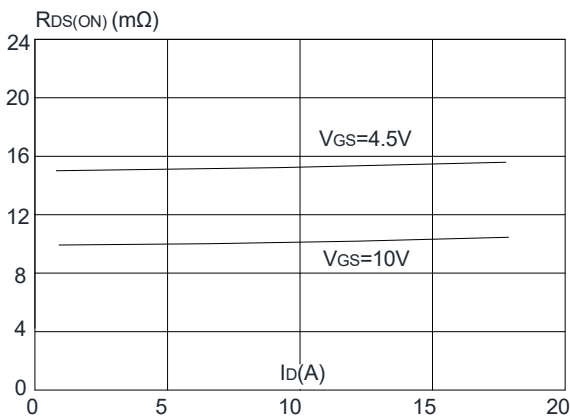

Figure 3: On-resistance vs. Drain Current

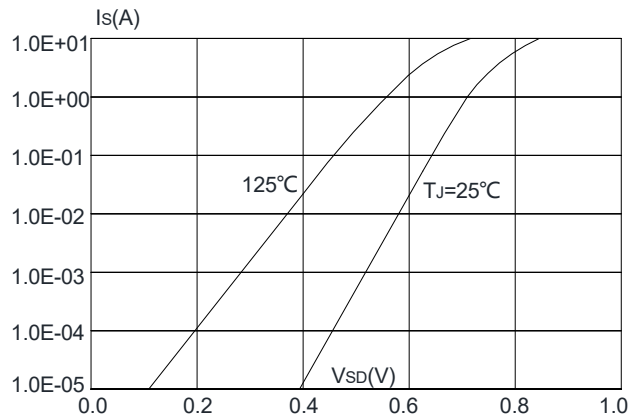

Figure 4: Body Diode Characteristics

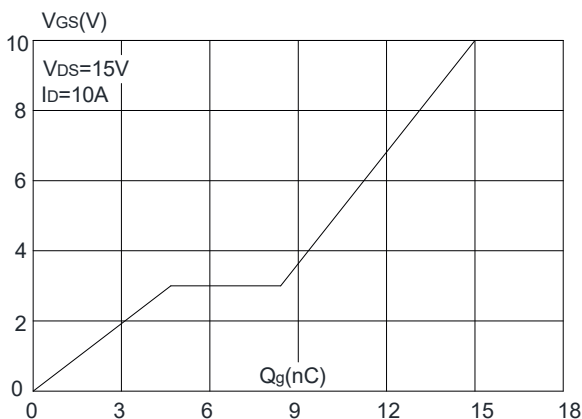

Figure 5: Gate Charge Characteristics

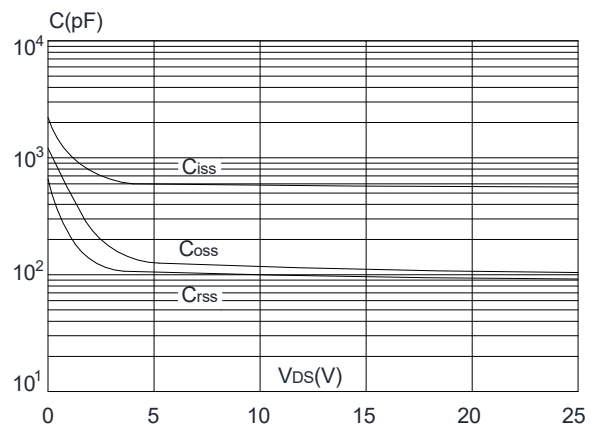

Figure 6: Capacitance Characteristics

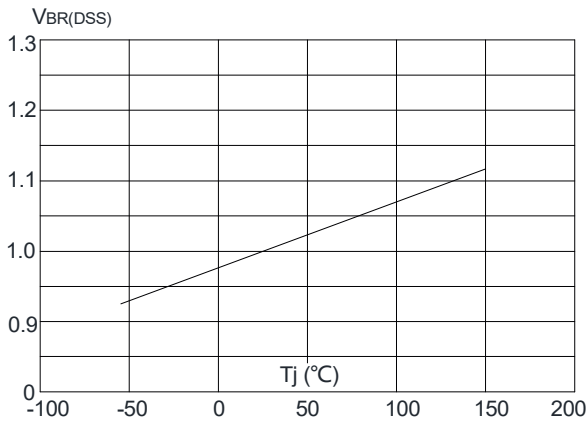

Figure 7: Normalized Breakdown Voltage vs. Junction Temperature

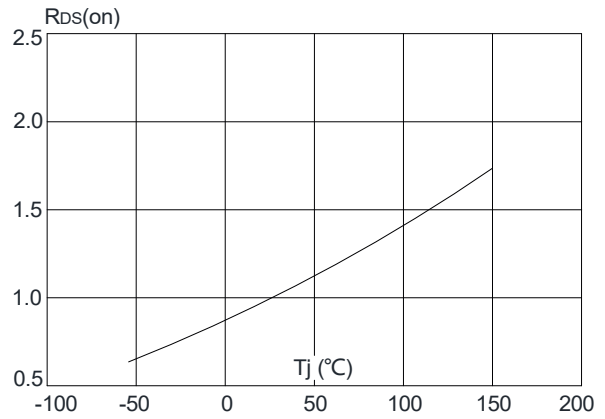

Figure 8: Normalized on Resistance vs. Junction Temperature

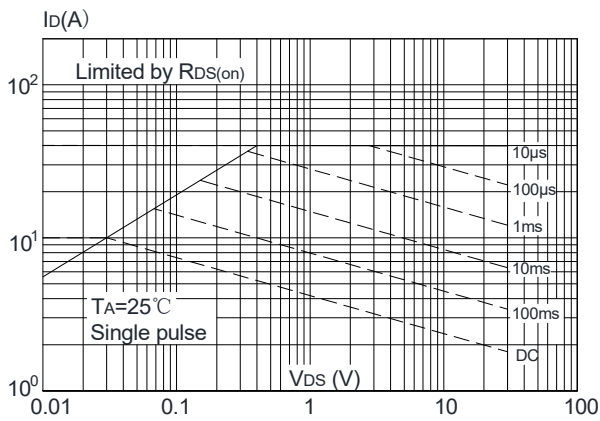

Figure 9: Maximum Safe Operating Area

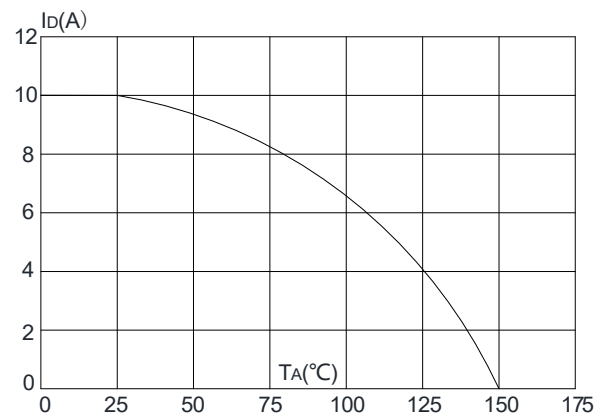

Figure 10: Maximum Continuous Drain Current vs. Ambient Temperature

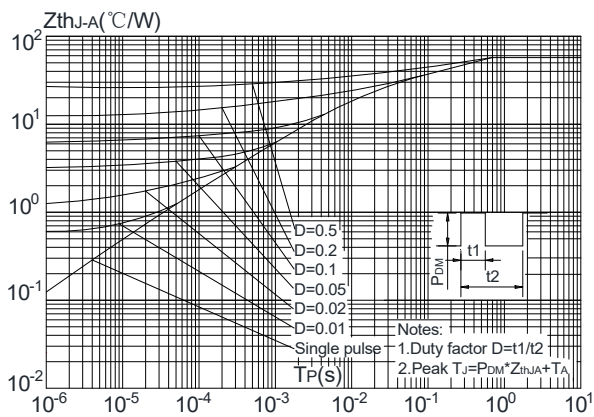

Figure.11: Maximum Effective Transient Thermal Impedance, Junction-to-Ambient



SOP-8 Package Outline Dimensions



Symbol	Dimensions In Millimeters		Dimensions In Inches	
	Min	Max	Min	Max
A	1.350	1.750	0.053	0.069
A1	0.100	0.250	0.004	0.010
A2	1.350	1.550	0.053	0.061
b	0.330	0.510	0.013	0.020
c	0.170	0.250	0.007	0.010
D	4.800	5.000	0.189	0.197
e	1.270 (BSC)		0.050 (BSC)	
E	5.800	6.200	0.228	0.244
E1	3.800	4.000	0.150	0.157
L	0.400	1.270	0.016	0.050
θ	0°	8°	0°	8°

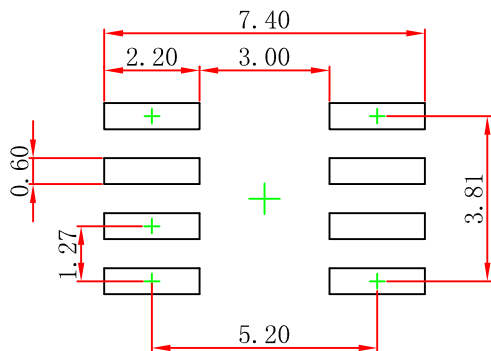

Note:
 1. Controlling dimension: in millimeters.
 2. General tolerance: $\pm 0.05\text{mm}$.
 3. The pad layout is for reference purposes only.



Attention

- Any and all HUA XUAN YANG ELECTRONICS products described or contained herein do not have specifications that can handle applications that require extremely high levels of reliability, such as life-support systems, aircraft's control systems, or other applications whose failure can be reasonably expected to result in serious physical and/or material damage. Consult with your HUA XUAN YANG ELECTRONICS representative nearest you before using any HUA XUAN YANG ELECTRONICS products described or contained herein in such applications.
- HUA XUAN YANG ELECTRONICS assumes no responsibility for equipment failures that result from using products at values that exceed, even momentarily, rated values (such as maximum ratings, operating condition ranges, or other parameters) listed in products specifications of any and all HUA XUAN YANG ELECTRONICS products described or contained herein.
- Specifications of any and all HUA XUAN YANG ELECTRONICS products described or contained herein stipulate the performance, characteristics, and functions of the described products in the independent state, and are not guarantees of the performance, characteristics, and functions of the described products as mounted in the customer's products or equipment. To verify symptoms and states that cannot be evaluated in an independent device, the customer should always evaluate and test devices mounted in the customer's products or equipment.
- HUA XUAN YANG ELECTRONICS CO.,LTD. strives to supply high-quality high-reliability products. However, any and all semiconductor products fail with some probability. It is possible that these probabilistic failures could give rise to accidents or events that could endanger human lives, that could give rise to smoke or fire, or that could cause damage to other property. When designing equipment, adopt safety measures so that these kinds of accidents or events cannot occur. Such measures include but are not limited to protective circuits and error prevention circuits for safe design, redundant design, and structural design.
- In the event that any or all HUA XUAN YANG ELECTRONICS products(including technical data, services) described or contained herein are controlled under any of applicable local export control laws and regulations, such products must not be exported without obtaining the export license from the authorities concerned in accordance with the above law.
- No part of this publication may be reproduced or transmitted in any form or by any means, electronic or mechanical, including photocopying and recording, or any information storage or retrieval system, or otherwise, without the prior written permission of HUA XUAN YANG ELECTRONICS CO.,LTD.
- Information (including circuit diagrams and circuit parameters) herein is for example only ; it is not guaranteed for volume production. HUA XUAN YANG ELECTRONICS believes information herein is accurate and reliable, but no guarantees are made or implied regarding its use or any infringements of intellectual property rights or other rights of third parties.
- Any and all information described or contained herein are subject to change without notice due to product/technology improvement, etc. When designing equipment, refer to the "Delivery Specification" for the HUA XUAN YANG ELECTRONICS product that you intend to use.