



### Description

The SI7804DN-T1-E3 uses advanced trench technology to provide excellent  $R_{DS(ON)}$ , low gate charge and operation with gate voltages as low as 4.5V. This device is suitable for use as a Battery protection or in other Switching application.

### General Features

$V_{DS} = 30V$   $I_D = 20A$

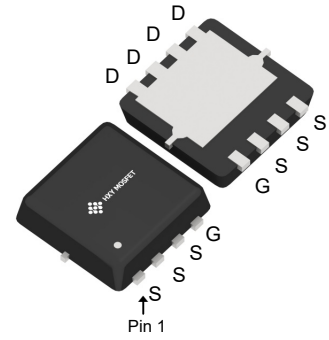
$R_{DS(ON)} < 20m\Omega$  @  $V_{GS}=10V$

### Application

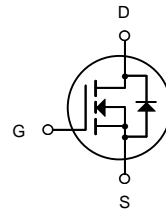
Battery protection

Load switch

Uninterruptible power supply



DFN3X3-8L



N-Channel MOSFET

### Ordering Information

Product ID	Pack	Brand	Qty(PCS)
SI7804DN-T1-E3	DFN3X3-8L	HXY MOSFET	5000

### Absolute Maximum Ratings ( $T_C=25^\circ C$ unless otherwise noted)

Symbol	Parameter	Rating	Units
V <sub>DS</sub>	Drain-Source Voltage	30	V
V <sub>GS</sub>	Gate-Source Voltage	±20	V
I <sub>D</sub> @T <sub>C</sub> =25°C	Continuous Drain Current, V <sub>GS</sub> @ 10V	20	A
I <sub>D</sub> @T <sub>C</sub> =100°C	Continuous Drain Current, V <sub>GS</sub> @ 10V	8	A
I <sub>DM</sub>	Pulsed Drain Current	38	A
E <sub>AS</sub>	Single Pulse Avalanche Energy	28	mJ
I <sub>AS</sub>	Avalanche Current	13.8	A
P <sub>D</sub> @T <sub>C</sub> =25°C	Total Power Dissipation	5.5	W
T <sub>STG</sub>	Storage Temperature Range	-55 to 175	°C
T <sub>J</sub>	Operating Junction Temperature Range	-55 to 175	°C
R <sub>θJC</sub>	Thermal Resistance Junction-Case	36	°C/W



**Electrical Characteristics** ( $T_J=25^\circ\text{C}$  unless otherwise specified)

Symbol	Parameter	Test Condition	Min.	Typ.	Max.	Units
$V_{(BR)DSS}$	Drain-Source Breakdown Voltage	$V_{GS}=0V, I_D=250\mu A$	30	-	-	V
$I_{DSS}$	Zero Gate Voltage Drain Current	$V_{DS}=30V, V_{GS}=0V,$	-	-	1.0	$\mu A$
$I_{GSS}$	Gate to Body Leakage Current	$V_{DS}=0V, V_{GS}=\pm 20V$	-	-	$\pm 100$	nA
$V_{GS(th)}$	Gate Threshold Voltage	$V_{DS}=V_{GS}, I_D=250\mu A$	1.0	1.5	2.5	V
$R_{DS(on)}$	Static Drain-Source on-Resistance <small>note3</small>	$V_{GS}=10V, I_D=5A$	-	15	20	m $\Omega$
		$V_{GS}=4.5V, I_D=3A$	-	21	29	
$C_{iss}$	Input Capacitance	$V_{DS}=15V, V_{GS}=0V,$ $f=1.0MHz$	-	490	-	pF
$C_{oss}$	Output Capacitance		-	79	-	pF
$C_{rss}$	Reverse Transfer Capacitance		-	61	-	pF
$Q_g$	Total Gate Charge	$V_{DS}=15V, I_D=5.8A,$ $V_{GS}=10V$	-	10	-	nC
$Q_{gs}$	Gate-Source Charge		-	1.7	-	nC
$Q_{gd}$	Gate-Drain("Miller") Charge		-	2.5	-	nC
$t_{d(on)}$	Turn-on Delay Time	$V_{DS}=15V, I_D=3A,$ $V_{GS}=10V, R_{REN}=3\Omega$	-	6	-	ns
$t_r$	Turn-on Rise Time		-	15	-	ns
$t_{d(off)}$	Turn-off Delay Time		-	17	-	ns
$t_f$	Turn-off Fall Time		-	17	-	ns
$I_S$	Maximum Continuous Drain to Source Diode Forward Current		-	-	9	A
$I_{SM}$	Maximum Pulsed Drain to Source Diode Forward Current		-	-	36	A
$V_{SD}$	Drain to Source Diode Forward Voltage	$V_{GS}=0V, I_S=9A$	-	-	1.2	V
$t_{rr}$	Body Diode Reverse Recovery Time	$I_F=5A, di/dt=100A/\mu s$	-	7	-	ns
$Q_{rr}$	Body Diode Reverse Recovery Charge		-	2	-	nC

Notes:1. Repetitive Rating: Pulse Width Limited by Maximum Junction Temperature

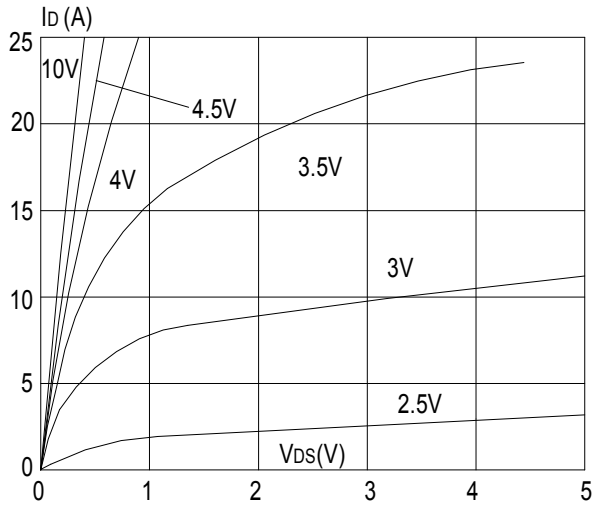
2. EAS condition :  $T_J=25^\circ\text{C}, V_{DD}=15V, V_G=10V, L=0.5mH, R_g=25\Omega, I_{AS}=6A$

3. Pulse Test: Pulse Width $\leq 300\mu s$ , Duty Cycle $\leq 0.5\%$

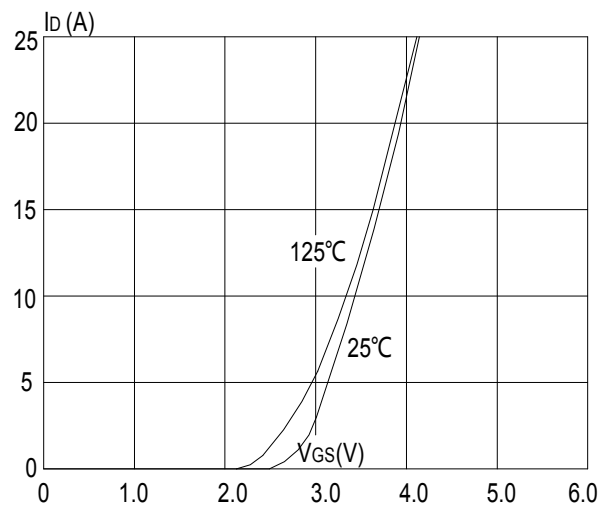


### Typical Performance Characteristics

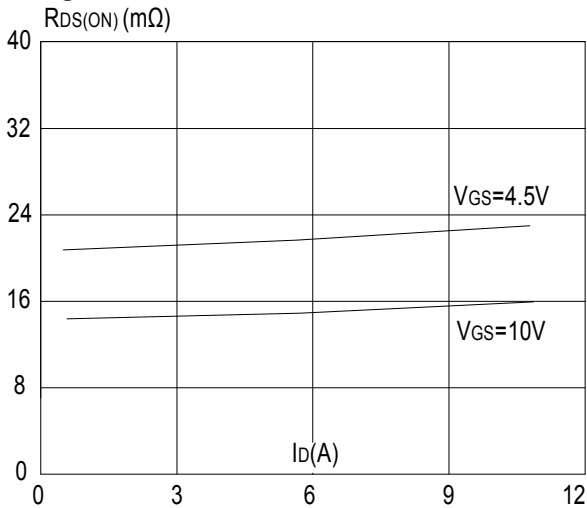
**Figure 1:** Output Characteristics



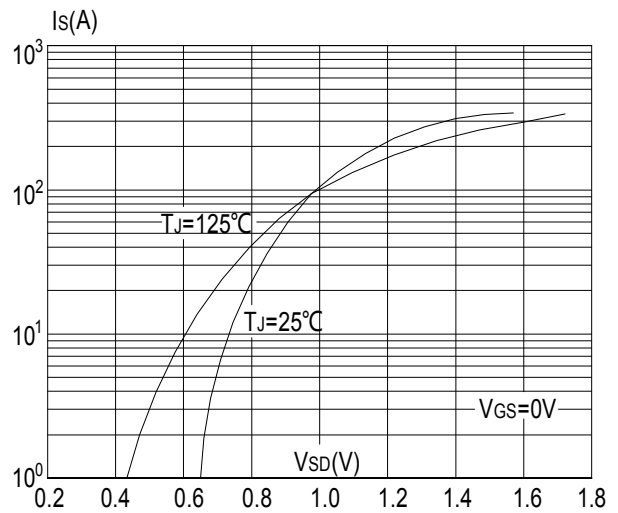
**Figure 2:** Typical Transfer Characteristics



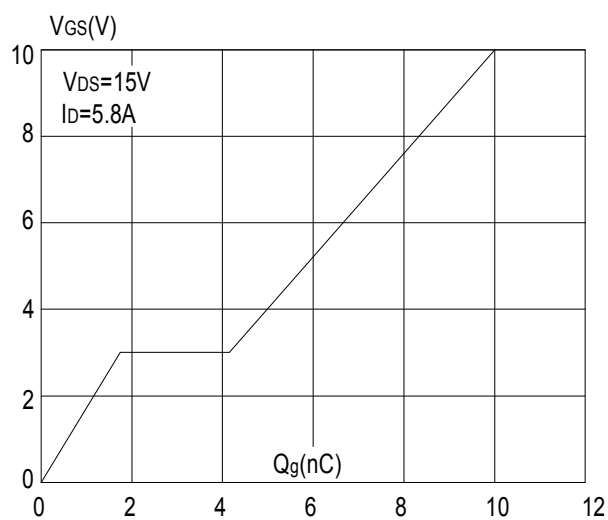
**Figure 3:** On-resistance vs. Drain Current



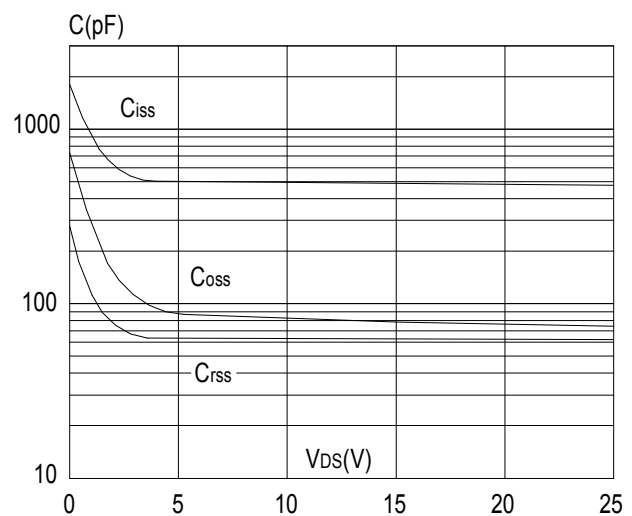
**Figure 4:** Body Diode Characteristics



**Figure 5:** Gate Charge Characteristics

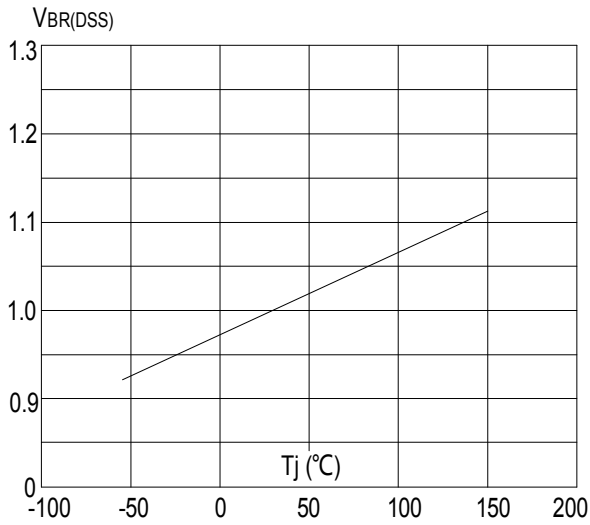


**Figure 6:** Capacitance Characteristics

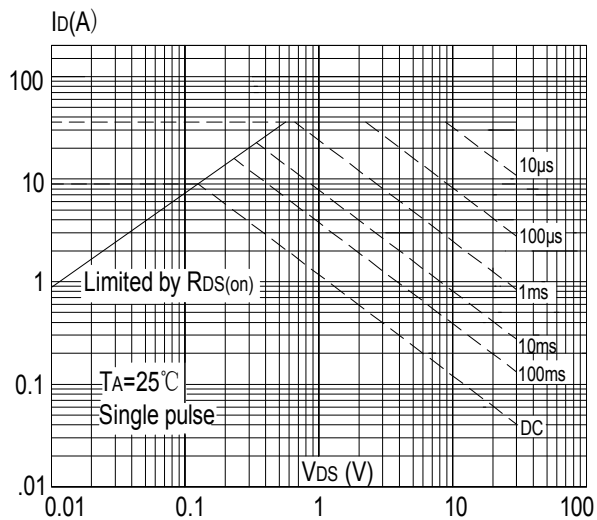




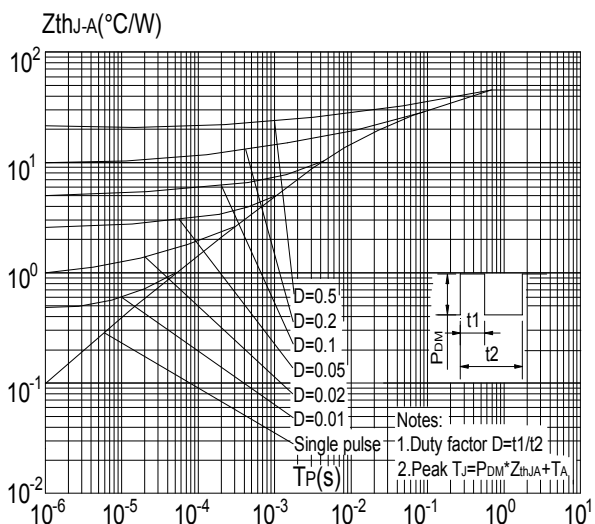
**Figure 7:** Normalized Breakdown Voltage vs. Junction Temperature



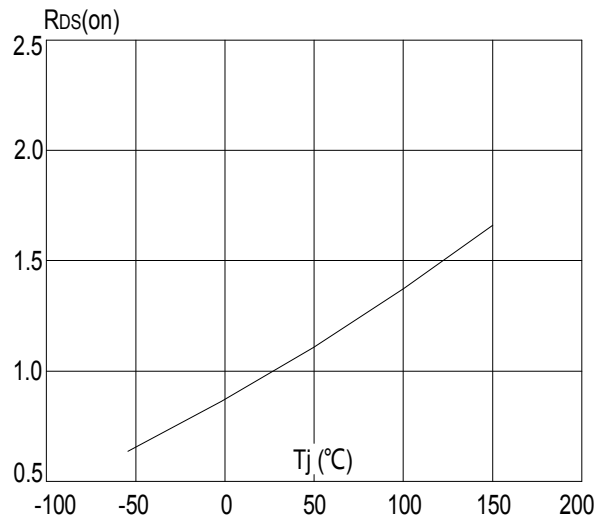
**Figure 9:** Maximum Safe Operating Area



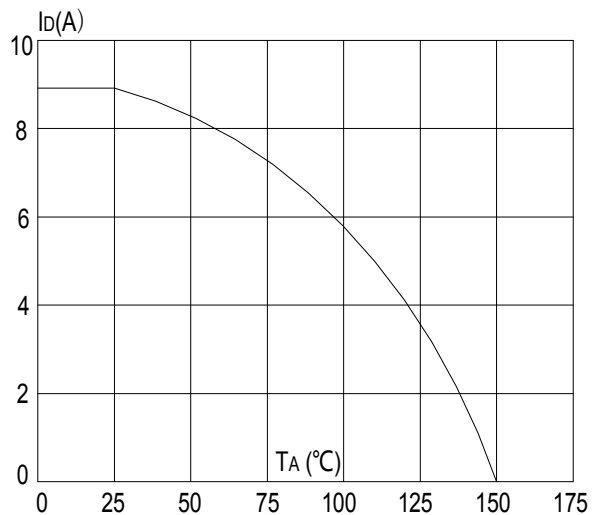
**Figure.11:** Maximum Effective Transient Thermal Impedance, Junction-to-Ambient



**Figure 8:** Normalized on Resistance vs. Junction Temperature



**Figure 10:** Maximum Continuous Drain Current vs. Ambient Temperature





### Test Circuit

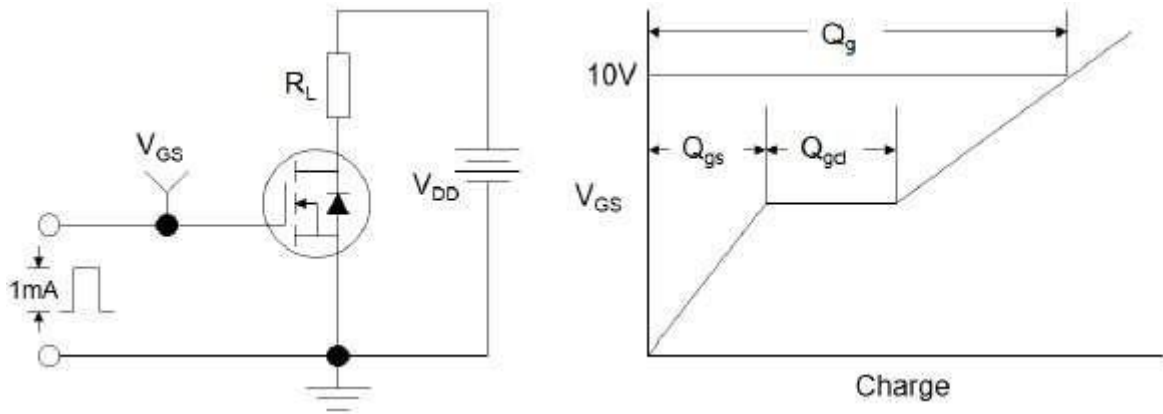


Figure1:Gate Charge Test Circuit & Waveform

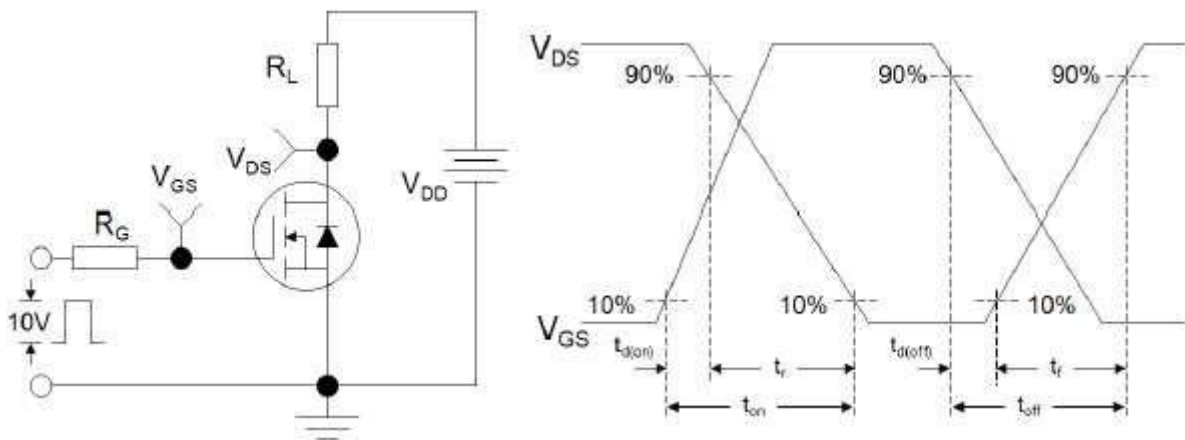


Figure 2: Resistive Switching Test Circuit & Waveforms

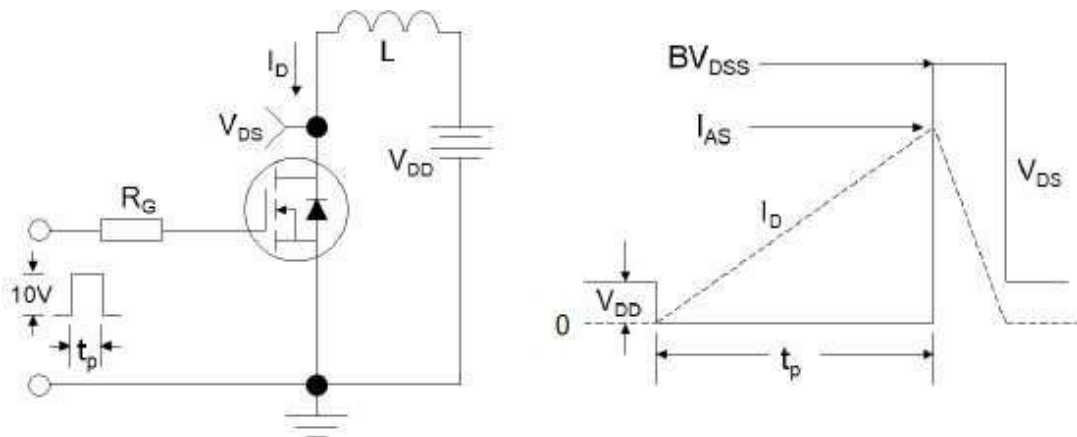
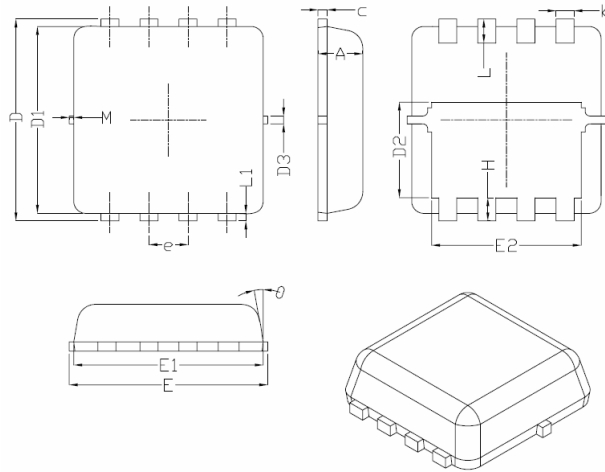


Figure 3:Unclamped Inductive Switching Test Circuit & Waveforms



**DFN3X3-8L Package Information**



Symbol	Dimensions In Millimeters		
	Min.	Nom.	Max.
A	0.70	0.75	0.80
b	0.25	0.30	0.35
c	0.10	0.15	0.25
D	3.25	3.35	3.45
D1	3.00	3.10	3.20
D2	1.48	1.58	1.68
D3	-	0.13	-
E	3.20	3.30	3.40
E1	3.00	3.15	3.20
E2	2.39	2.49	2.59
e	0.65BSC		
H	0.30	0.39	0.50
L	0.30	0.40	0.50
L1	-	0.13	-
M	*	*	0.15
θ		10°	12°



### Attention

- Any and all HUA XUAN YANG ELECTRONICS products described or contained herein do not have specifications that can handle applications that require extremely high levels of reliability, such as life-support systems, aircraft's control systems, or other applications whose failure can be reasonably expected to result in serious physical and/or material damage. Consult with your HUA XUAN YANG ELECTRONICS representative nearest you before using any HUA XUAN YANG ELECTRONICS products described or contained herein in such applications.
- HUA XUAN YANG ELECTRONICS assumes no responsibility for equipment failures that result from using products at values that exceed, even momentarily, rated values (such as maximum ratings, operating condition ranges, or other parameters) listed in products specifications of any and all HUA XUAN YANG ELECTRONICS products described or contained herein.
- Specifications of any and all HUA XUAN YANG ELECTRONICS products described or contained herein stipulate the performance, characteristics, and functions of the described products in the independent state, and are not guarantees of the performance, characteristics, and functions of the described products as mounted in the customer's products or equipment. To verify symptoms and states that cannot be evaluated in an independent device, the customer should always evaluate and test devices mounted in the customer's products or equipment.
- HUA XUAN YANG ELECTRONICS CO.,LTD. strives to supply high-quality high-reliability products. However, any and all semiconductor products fail with some probability. It is possible that these probabilistic failures could give rise to accidents or events that could endanger human lives, that could give rise to smoke or fire, or that could cause damage to other property. When designing equipment, adopt safety measures so that these kinds of accidents or events cannot occur. Such measures include but are not limited to protective circuits and error prevention circuits for safe design, redundant design, and structural design.
- In the event that any or all HUA XUAN YANG ELECTRONICS products(including technical data, services) described or contained herein are controlled under any of applicable local export control laws and regulations, such products must not be exported without obtaining the export license from the authorities concerned in accordance with the above law.
- No part of this publication may be reproduced or transmitted in any form or by any means, electronic or mechanical, including photocopying and recording, or any information storage or retrieval system, or otherwise, without the prior written permission of HUA XUAN YANG ELECTRONICS CO.,LTD.
- Information (including circuit diagrams and circuit parameters) herein is for example only ; it is not guaranteed for volume production. HUA XUAN YANG ELECTRONICS believes information herein is accurate and reliable, but no guarantees are made or implied regarding its use or any infringements of intellectual property rights or other rights of third parties.
- Any and all information described or contained herein are subject to change without notice due to product/technology improvement, etc. When designing equipment, refer to the "Delivery Specification" for the HUA XUAN YANG ELECTRONICS product that you intend to use.