

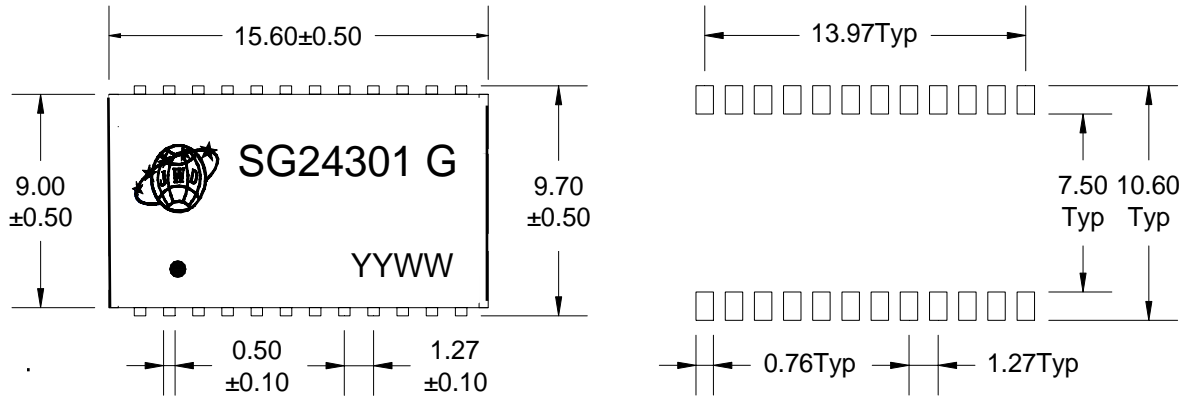

绵阳高新区经纬达科技有限公司

Mianyang Highly-Tech Jingweida Scientific Co., Ltd

A. MECHANICAL(unit:mm)



SUGGESTED PAD LAYOUT

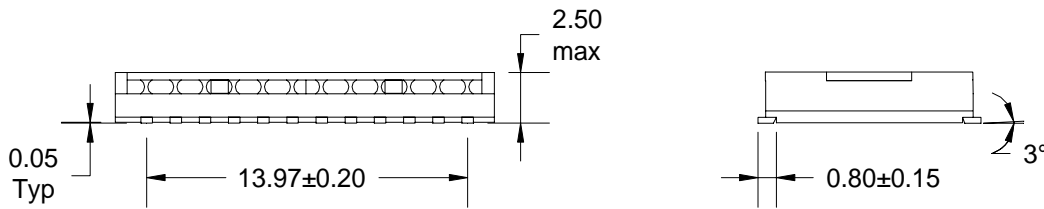

B. SCHEMATICS

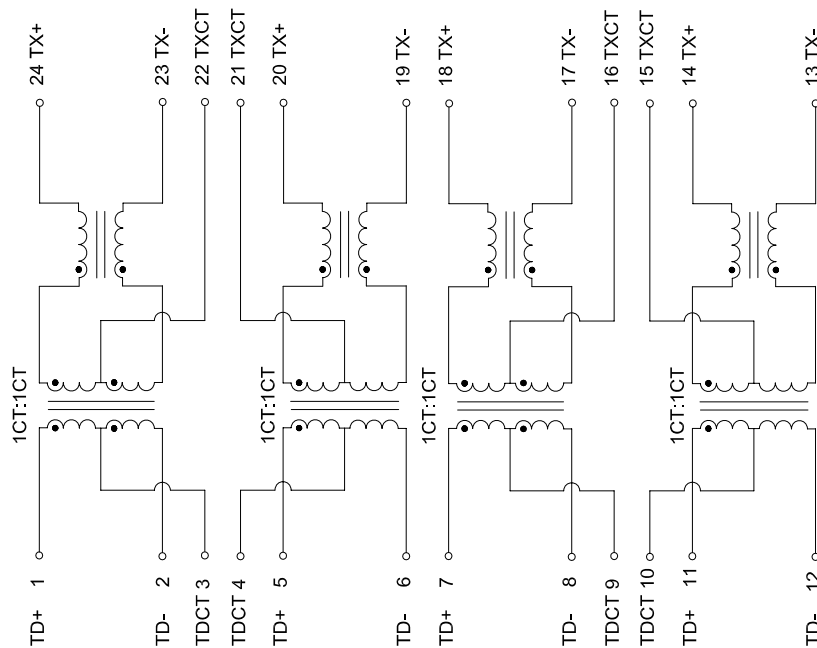

DESCRIPTION	JWD P/N	SPEC NO	REV: R0
100/1000 BASE-T	SG24301 G		PAGE: 1/3



绵阳高新区经纬达科技有限公司

Mianyang Highly-Tech Jingweida Scientific Co., Ltd

C. ELECTRICAL SPECIFICATIONS @25°C

1. OCL: 350uH Min @ 100KHz, 0.1V
2. Leakage Inductance: 0.5uH Max @ 100KHz, 0.1V
3. DCR: 1400mΩ Max
4. Turns Ratio: 1CT:1CT±5%
5. Insertion Loss: -1.1 dB Max @ 1-100 MHz
6. Return Loss: -18 dB Min @ 1-30 MHz
 - 14.4 dB Min @40 MHz
 - 13.1 dB Min @ 50 MHz
 - 12 dB Min @ 60-80 MHz
 - 10 dB Min @ 100 MHz
7. Cross Talk: -30 dB Min @ 1-100 MHz
8. Common Mode Rejection: -30 dB Min @ 1-100 MHz
9. Isolation Hipot: 1500VAC 1mA 60S
10. Operating temperature 0°C to +70°C
11. Storage temperature -25°C to +125°C

DESCRIPTION	JWD P/N	SPEC NO	REV: R0
100/1000 BASE-T	SG24301 G		PAGE: 2/3



绵阳高新区经纬达科技有限公司

Mianyang Highly-Tech Jingweida Scientific Co., Ltd

D. PACKAGE INFORMATION

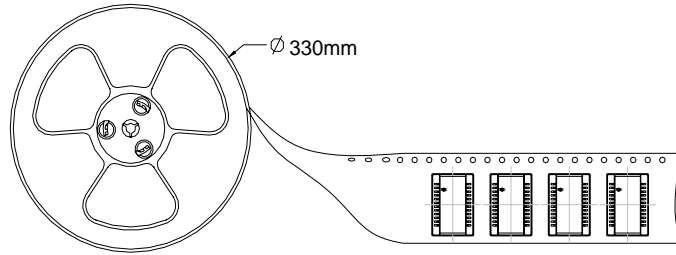
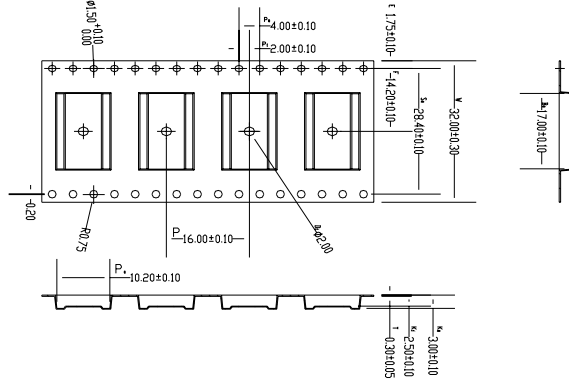

备注: 每卷载带前空14格,后空12格 (靠近卷轴端为前)

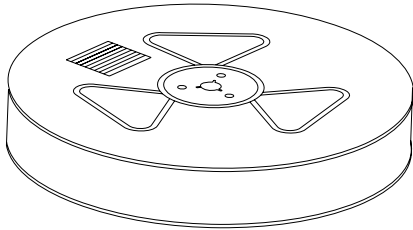

two reel

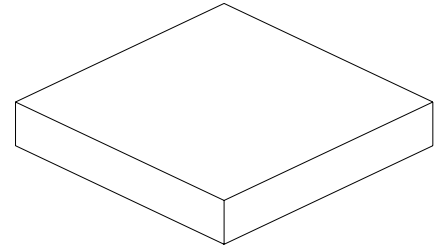

Inner Carton

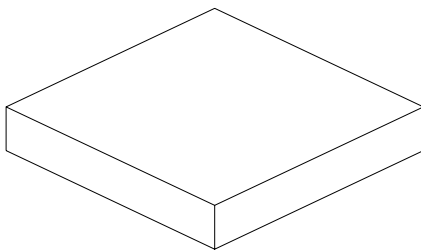

two Inner Carton

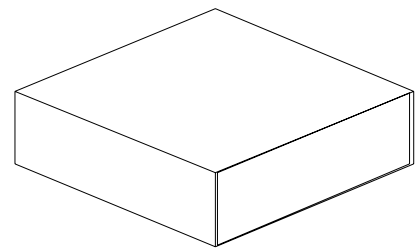

Export Carton

Package Quantity:

One Reel=1000Pcs

One Inner Carton=1000*3=3000Pcs

One Export Carton=3000*2=6000Pcs

DESCRIPTION	JWD P/N	SPEC NO	REV: R0
100/1000 BASE-T	SG24301 G		PAGE: 3/3