

直插接线, 请勿上掰操作杆, 否则易损坏

7	8	9
标记 MARK	ECN编号/变更内容 ECN NO/DEFINITION	修改 REVISE
		日期 DATE
		核准 APPROVE

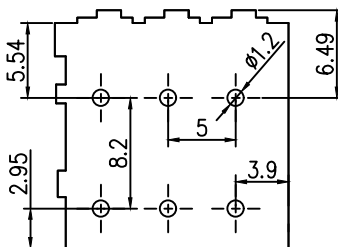
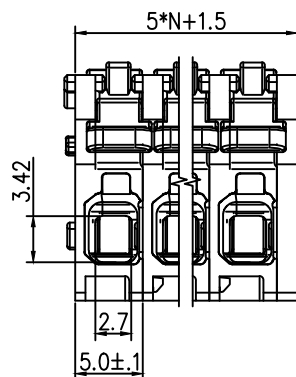
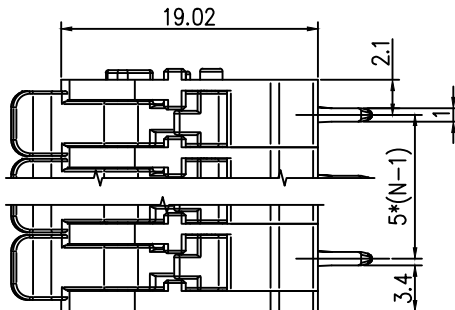
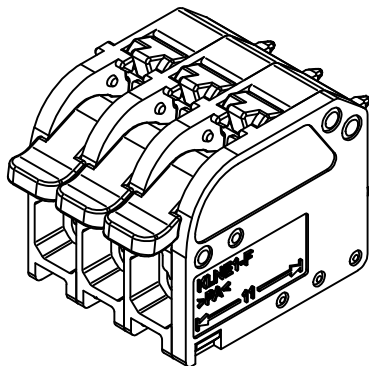
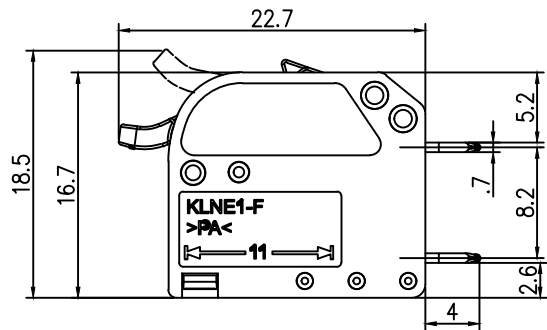

Footprint for information only

1. 额定电压/电流: 300V/20A
2. 额定脉冲电压: 4kv
3. 线径范围(硬线&软线)  
(mm<sup>2</sup> /AWG): 0.5...2.5/20...12
4. 间距/线数范围: 5.0/N=2~24P
5. 剥线长度: 10-12mm
6. 使用温度范围: -40℃~+85℃

2	接触	铜	镀银锡	
1	基座	PA66	灰色	
序号	品名	材质	电镀/颜色	备注

	深圳市虹成电子有限公司		品名 TITLE	接线端子
			料号 PART NO	HC-JXDZFV-5.0-5P
GENERAL TOLERANCES (UNLESS SPECIFIED)		比列 SCALE	1:1	
0~3	±0.12	>3~6	±0.18	
>6~10	±0.22	>10~18	±0.26	
>18~30	±0.31	>30~50	±0.37	
>50~80	±0.57	>120~180	±0.80	
>180~250	±0.93	>250~315	±1.05	
>315~400	±1.60	>400~500	±2.20	
>500	±2.50			
单位 UNIT	MM	制图 DRAW	AhYe	
张数 PART NO	1 OF 1	审核 CHECKED	夏操云	
版本 REV	A	批准 APPROVE	赵亮亮	