

## Features

- Wide Supply Voltage Range: 2.9V to 5.5V
- Compliant to USB Specifications
- Current-Limit and Short-Circuit Protections
- Enable Active Low/High
- Typical R<sub>ds(on)</sub> 40mΩ (typ)
- Typical 2.1V under voltage lockout
- Output can be forced higher than input (Off-state)
- Hot Plug-In Application(Soft start)
- Low supply current 35uA at switch on state
- Open Drain Fault Flag Output
- Reverse Current Flow Blocking (no body diode)
- RoHS and Halogen free compliance
- CB IEC60950-1 Certification
- TUV EN60950-1 Certification
- UL Approved-E353665

## Applications

- USB Ports
- Notebook and Desktop Computers
- High-Side Power Protection Switches
- Consumer Electronics
- Telecom Systems
- Digital TV
- USB Device Power Switch
- Motherboard USB Power Switch

## Pin Configurations

Pin Number	Pin Name	Pin Function
1	VOUT	Output Voltage Pin.
2	GND	Ground.
3	$\overline{\text{FLG}}$	Fault FLAG Output.
4	$\text{EN}/\overline{\text{EN}}$	Enable Input, Chip Enable(Active High/Low).
5	VIN	Power Supply Input. Connect this pin to external DC supply.

## Marking:

TPU3013S5 : YD\*\*\*  
\*\*\*: \* IS Lot Number

## General Description

The is a low voltage, single NMOSFET high-side power switch, optimized for self-powered and bus-powered Universal serial bus (USB) application. equipped with a charge pump circuitry to drive the internal NMOSFET switch, the switch's low R<sub>ds(on)</sub> 40mΩ, meets USB voltage droop requirement and a flag output is available to indicate fault conditions to the local USB controller.

Additional features include soft-start to limit the inrush current during plug-in, thermal shutdown to prevent catastrophic switch failure from high-current loads, under voltage lockout (UVLO) to ensure that the device remains off unless there is a valid input voltage present. The low quiescent current as 35uA makes this device ideal for portable battery operated equipment.

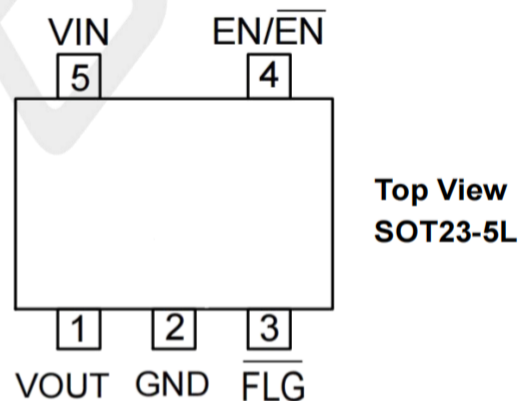

# TPUxx12S5&TPUxx13S5 Series Low Loss Power Switch With Flag

[WWW.TECHPUBLIC.COM](http://WWW.TECHPUBLIC.COM)

## Ordering Information

PRODUCT MODEL	Current Limit	ENABLE	PACKAGE
TPU0512S5	0.5A	Active Low	SOT23-5L
TPU0513S5	0.5A	Active High	SOT23-5L
TPU1012S5	1.0A	Active Low	SOT23-5L
TPU1013S5	1.0A	Active High	SOT23-5L
TPU1512S5	1.5A	Active Low	SOT23-5L
TPU1513S5	1.5A	Active High	SOT23-5L
TPU2012S5	2.0A	Active Low	SOT23-5L
TPU2013S5	2.0A	Active High	SOT23-5L
TPU2512S5	2.5A	Active Low	SOT23-5L
TPU2513S5	2.5A	Active High	SOT23-5L
TPU3012S5	3.0A	Active Low	SOT23-5L
TPU3013S5	3.0A	Active High	SOT23-5L

## Absolute Maximum Ratings

over operating free-air temperature range (unless otherwise noted)

Characteristics	Symbol	Rating	Unit	
Supply Input Voltage	$V_{IN}$	6.5	V	
EN Input Voltages and VOUT Voltages		-0.3 to 6.5	V	
FLAG Voltage		6.5	V	
Package Power Dissipation	$P_D$	$P_D=(T_J-T_A)/\theta_{JA}$	W	
Operating Temperature Range		-40 to 85	°C	
Junction Temperature	$T_J$	-40~125	°C	
Storage Temperature Range	$T_S$	-65 to +150	°C	
ESD Rating (Note)	HBM(Human Body Mode)	HBM	2000	V
	MM (Machine Mode)	MM	200	V
Thermal Resistance from Junction to ambient	$\theta_{JA}$	218	°C/W	
Thermal Resistance from Junction to case	$\theta_{JC}$	130	°C/W	

### Electrical Characteristics

( $V_{IN}=5V$ ,  $C_{IN}=1\mu F$ ,  $C_{OUT}=10\mu F$  per channel,  $T_A = 25^\circ C$ , unless otherwise specified)

Characteristics	Symbol	Conditions	Min	Typ	Max	Units	
Input Voltage Range	$V_{IN}$		2.9	--	5.5	V	
Under Voltage Lockout	$V_{UVLO}$	$V_{IN}$ Increase	1.7	2.1	2.4	V	
Under Voltage Hysteresis		$V_{IN}$ Decrease	--	100	--	mV	
Input Leakage Current	$I_{LEAK}$	Disabled, OUT grounded		0.1	1	$\mu A$	
Output Leakage Current	TPU05XXXX TPU10XXXX TPU15XXXX	Disabled, $R_{LOAD}=0\Omega$	--	0.5	10	$\mu A$	
	TPU20XXXX TPU25XXXX TPU30XXXX	Disabled, $R_{LOAD}=0\Omega$	--	0.5	1	$\mu A$	
Reverse Leakage Current	$I_{REV}$	Disabled, $V_{IN}=0V$ , $V_{OUT}=5V$ , $I_{REV}$ at $V_{IN}$	--	0.1	1	$\mu A$	
Switch On Resistance	TPU05XXXX TPU10XXXX TPU15XXXX TPU20XXXX	$R_{DSON}$	$V_{IN}=3.3V$ , $I_{OUT}=0.5A$	--	60	75	m $\Omega$
			$V_{IN}=5.0V$ , $I_{OUT}=0.5A$	--	60	75	m $\Omega$
	TPU25XXXX TPU30XXXX		$V_{IN}=3.3V$ , $I_{OUT}=0.5A$	--	40	50	m $\Omega$
	$V_{IN}=5.0V$ , $I_{OUT}=0.5A$		--	40	50	m $\Omega$	
Supply Current	TPU05XXXX TPU10XXXX TPU15XXXX	$I_Q$	Switch On, $V_{OUT} = OPEN$	--	35	55	$\mu A$
	TPU20XXXX TPU25XXXX TPU30XXXX	$I_{SHDN}$	Switch Off, $V_{OUT} = OPEN$	--	0.1	1	$\mu A$
EN Threshold	TPU05XXXX TPU10XXXX TPU15XXXX	$V_{IL}$	Low Voltage	--	--	0.7	V
— EN Threshold	TPU20XXXX TPU25XXXX TPU30XXXX	$V_{IH}$	High Voltage	1.3	--	--	V
— EN/EN Input Current	$I_{SINK}$	— $V_{EN}/EN$ From 0V to 5V	--	0.01	--	$\mu A$	

### Electrical Characteristics

( $V_{IN}=5V$ ,  $C_{IN}=1\mu F$ ,  $C_{OUT}=10\mu F$  per channel,  $T_A = 25^\circ C$ , unless otherwise specified)

Characteristics		Symbol	Conditions		Min	Typ	Max	Units
Current Limit	TPU05XXXX	$I_{LIMIT}$	$V_{IN}= 5V, V_{OUT}= 4.5V$	$-40^\circ C \leq T_A \leq 85^\circ C$	0.6	0.9	1.3	A
	TPU10XXXX		$V_{IN}= 5V, V_{OUT}= 4.5V$	$-40^\circ C \leq T_A \leq 85^\circ C$	1.1	1.5	1.9	A
	TPU15XXXX		$V_{IN}= 5V, V_{OUT}= 4.5V$	$-40^\circ C \leq T_A \leq 85^\circ C$	1.6	2.1	2.6	A
	TPU20XXXX		$V_{IN}= 5V, V_{OUT}= 4.5V$	$-40^\circ C \leq T_A \leq 85^\circ C$	2.2	3.0	3.8	A
	TPU25XXXX		$V_{IN}= 5V, V_{OUT}= 4.5V$	$-40^\circ C \leq T_A \leq 85^\circ C$	2.7	3.5	4	A
	TPU30XXXX		$V_{IN}= 5V, V_{OUT}= 4.5V$	$-40^\circ C \leq T_A \leq 85^\circ C$	3.2	3.6	4.2	A
Short Circuit Fold back Current Hysteresis		$I_{SHORT}$	$V_{OUT}=0V$ , Measured prior to the thermal shutdown		--	1.2	--	A
Output Turn-on Rise Time	TPU05XXXX	$T_R$	$V_{IN}=3.3V, C_L=1\mu F, R_{load}=3\Omega$ , $V_{OUT}$ Rise From 10% to 90%		--	1.5	--	ms
	TPU10XXXX		$V_{IN}=5.0V, C_L=1\mu F, R_{load}=5\Omega$ , $V_{OUT}$ Rise From 10% to 90%		--	1.5	--	ms
	TPU15XXXX		$V_{IN}=3.3V, C_L=1\mu F, R_{load}=3\Omega$ , $V_{OUT}$ Rise From 10% to 90%		--	1.6	--	ms
	TPU20XXXX		$V_{IN}=5.0V, C_L=1\mu F, R_{load}=5\Omega$ , $V_{OUT}$ Rise From 10% to 90%		--	3.0	--	ms
Output Turn-on Delay Time	TPU05XXXX	$T_{D(ON)}$	$C_L=1\mu F, R_{load}=10\Omega$ , $\overline{EN}$ 10% ( $\overline{EN}$ 90%) to $V_{OUT}$ 10%		--	20	--	us
	TPU10XXXX		$C_L=1\mu F, R_{load}=10\Omega$ , $\overline{EN}$ 10% ( $\overline{EN}$ 90%) to $V_{OUT}$ 10%		--	50	--	us
	TPU15XXXX		$C_L=1\mu F, R_{load}=10\Omega$ , $\overline{EN}$ 10% ( $\overline{EN}$ 90%) to $V_{OUT}$ 10%		--	50	--	us
	TPU20XXXX		$C_L=1\mu F, R_{load}=10\Omega$ , $\overline{EN}$ 10% ( $\overline{EN}$ 90%) to $V_{OUT}$ 10%		--	50	--	us
Output Turn-off Fall Time		$T_F$	$C_L=1\mu F, R_{load}=10\Omega$ , $V_{OUT}$ Fall From 90% to 10%		--	20	--	us
Output Turn-off Delay Time		$T_{D(OFF)}$	$C_L=1\mu F, R_{load}=10\Omega$ , $\overline{EN}$ 90% ( $\overline{EN}$ 10%) to $V_{OUT}$ 90%		--	10	--	us
Reverse Current Limit		$I_{RLIMIT}$	$V_{IN}= 5V, V_{OUT}= 5.5V$ $-40^\circ C \leq T_A \leq 85^\circ C$		--	500	--	mA
Reverse Over Voltage Protect		$V_{ROVP}$	$V_{OUT} - V_{IN}$		--	150	--	mV
Reverse Protect Delay Time		$T_{PD}$			--	5	--	mS

## ELECTRICAL CHARACTERISTICS (CONTINUOUS)

( $V_{IN}=5V$ ,  $C_{IN}=1\mu F$ ,  $C_{OUT}=10\mu F$ ,  $T_A = 25^\circ C$ , unless otherwise specified)

Characteristics	Symbol	Conditions	Min	Typ	Max	Units
FLG Output Resistance	$R_{FLG}$	$I_{SINK}=1mA$	--	20	40	$\Omega$
FLG Off Current		$V_{FLG} = 5V$	--	0.01	1	$\mu A$
FLG DELAY TIME	$T_{Blank}$	From Fault Condition to $\overline{FLG}$ assertion	5	15	20	ms
Output Shutdown Discharge Resistance		Disabled	--	100	150	$\Omega$
Thermal Shutdown Threshold	$T_{SD}$	Enabled	--	150	--	$^\circ C$
Thermal Shutdown Hysteresis	$T_{HYS}$	$V_{OUT} = 0V$	--	20	--	$^\circ C$

Note 1: Thermal Resistance is specified with approximately 1 square of 1 oz copper.

2: 100% production test at  $+25^\circ C$ . Specifications over the temperature range are guaranteed by design and characterization. The device is not guaranteed to function outside its operating conditions.

## APPLICATION CIRCUIT

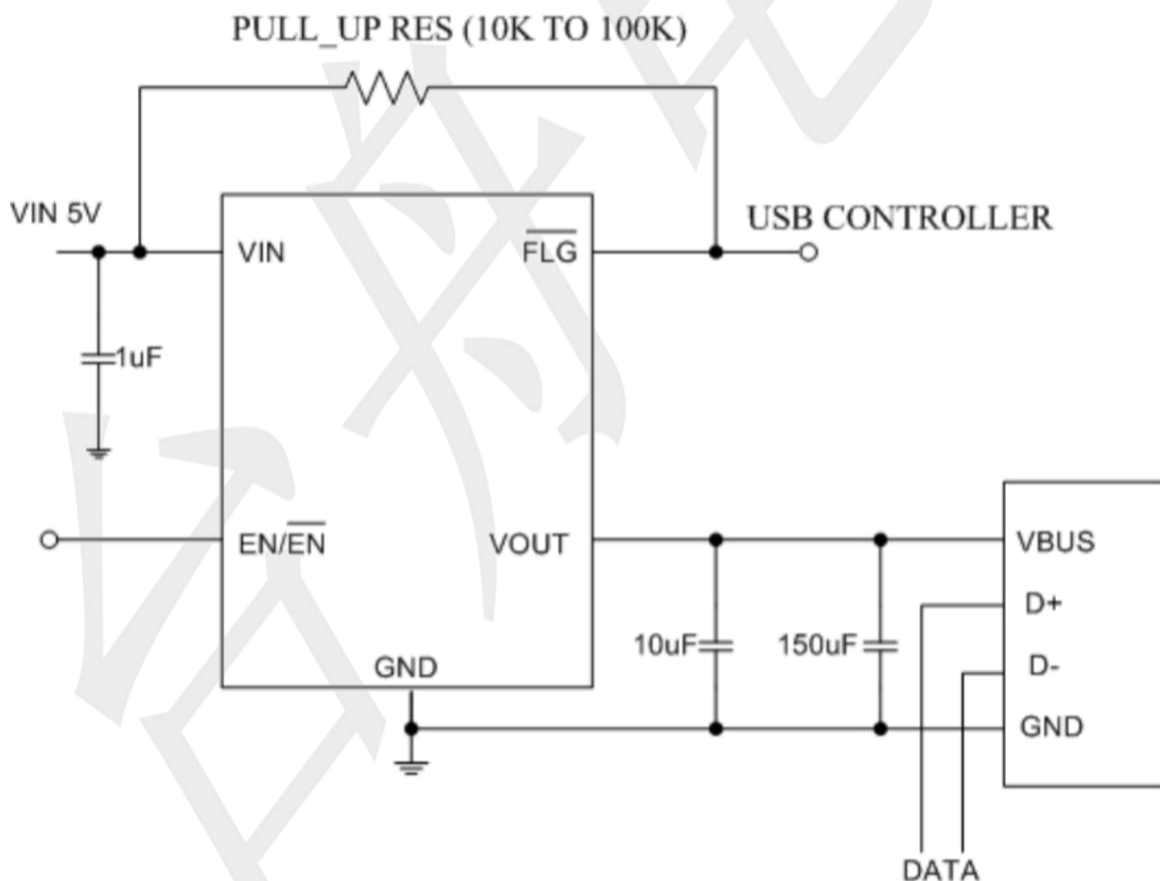

## APPLICATION INFORMATION

The is a single N-MOSFET high-side power switch with enable input, optimized for self-powered and bus-powered Universal Serial Bus (USB) applications. The series are equipped with a charge pump circuitry to drive the internal N-MOSFET switch; The switch's low  $R_{ds(on)}$ , 40m $\Omega$  meets USB voltage drop requirements and a flag output is available to indicate fault conditions to the local USB controller.

### Input and Output

VIN (Input) is the power source connection to the internal circuitry and the drain of the N-MOSFET. VOUT (Output) is the source of the N-MOSFET. In a typical application, current flows through the switch from VIN to VOUT toward the load. If VOUT is greater than VIN, current will flow from VOUT to VIN since the MOSFET is bidirectional when on. Unlike a normal MOSFET, there is no a parasitic body diode between drain and source of the MOSFET, the prevents reverse current flow if VOUT being externally forced to a higher voltage than VIN when the output .disabled ( $V_{EN} < 0.8V$  or  $V_{\overline{EN}} > 2V$ ).



### Enable

The switch will be disabled when the EN pin is low or  $\overline{EN}$  is high. During this condition, the internal circuitry and MOSFET are all turned off and the supply current reduces to 0.1uA typically. Floating the EN/ $\overline{EN}$  may cause unpredictable operation. EN should not be allowed to be negative to GND. The EN/ $\overline{EN}$  pin may be directly tied to VIN (GND) to keep the part on.

### UVLO

Under-Voltage Lockout (UVLO) prevents the power MOSFET from turning on until the input voltage is up to approximately 2.1V. If the input voltage drops blow about 2.0V, UVLO turns off the power MOSFET switch and  $\overline{FLG}$  will be asserted accordingly. Under voltage protection is function when the part is enabled.

### Soft Start for Hot Plug Application

In order to eliminate the upstream voltage droop caused by the large inrush current during the hot plug events, the soft start feature effectively isolates the power source from extremely large load capacitor, satisfying the USB voltage droop requirement.

### Fault Flag

The provides a  $\overline{FLG}$  signal pin which is an N-Channel open drain MOSFET output. This open drain output goes low when  $V_{OUT} < V_{IN} - 1V$ , current limit or the die temperature exceeds 150°C approximately. The  $\overline{FLG}$  output is typically about 200mV when sinking a 10mA load. A 100K pull up resistor is required at the  $\overline{FLG}$  pin.  $\overline{FLG}$  Pin will be asserted at the over-current condition after the flag response delay time  $T_D$ . This ensures that  $\overline{FLG}$  is asserted only at the valid over-current conditions and error reporting is eliminated.

## Current Limiting and Short-Circuit Protection

The current limit circuitry prevents damage to the MOSFET switch and the hub downstream port but can deliver load current up to the current limit threshold of typically 2.5A through the switch. When a heavy load or short circuit is applied to an enabled switch, a large transient current may flow until the current limit circuitry responds. Once this current limit threshold is exceeded the device enters constant current mode until the thermal shutdown occurs or the fault is removed.

## Thermal Shutdown

Thermal shutdown is employed to protect the device from damage if the die temperature exceeds approximately 150°C. If enabled, the switch automatically restarts when the die temperature falls 20°C. The output and  $\overline{\text{FLG}}$  signal will continue to cycle on and off until the device is disabled or the fault is removed.

## Input capacitor

A 1 $\mu\text{F}$  low ESR ceramic capacitor from VIN to GND, located at the device is strongly recommended to prevent the input voltage drooping during hot-plug events. However, higher capacitor values will further reduce the voltage droop at the input. Furthermore, without the bypass capacitor, an output short may cause sufficient ringing on the input (from source lead inductance) to destroy the internal control circuitry. The input transient must not exceed 6.5V of the absolute maximum supply voltage even for a short duration.

## Output capacitor

A low ESR 150 $\mu\text{F}$  aluminum electrolytic or tantalum between VOUT and GND is strongly recommended to meet the 330mV maximum droop requirement in the hub VBUS (Per USB 2.0, output ports must have a minimum 120 $\mu\text{F}$  of low ESR bulk capacitor per hub). Standard bypass methods should be used to minimize inductance and resistance between the bypass capacitor and the downstream connector to reduce EMI and decouple voltage droop caused when downstream cables are hot insertion transients. Ferrite beads in series with VBUS, the ground line and the 0.1 $\mu\text{F}$  bypass capacitors at the power connector pins are recommended for EMI and ESD protection. The bypass capacitor itself should have a low dissipation factor to allow decoupling at higher frequencies.

## PCB Layout Guide

For best performance of the , the following guidelines must be strictly followed:

1. Input and output capacitors should be placed close to the IC and connected to ground plane to reduce noise coupling.
2. The GND should be connected to a strong ground plane for heat sink.
3. Keep the main current traces as possible as short and wide.

### Typical Operating Characteristics

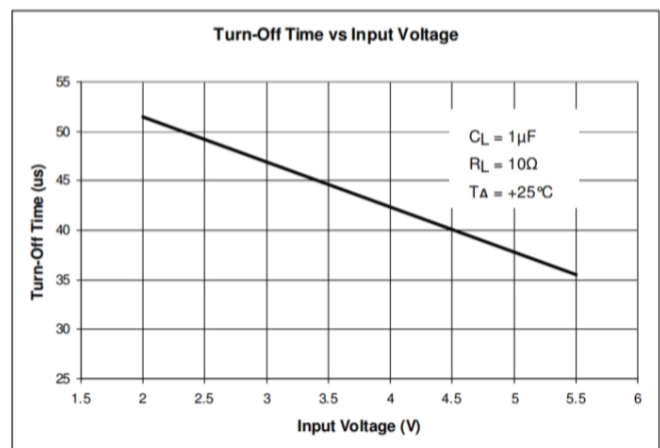
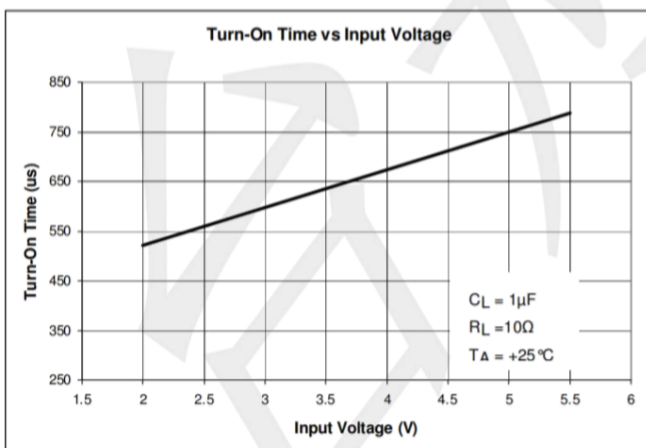
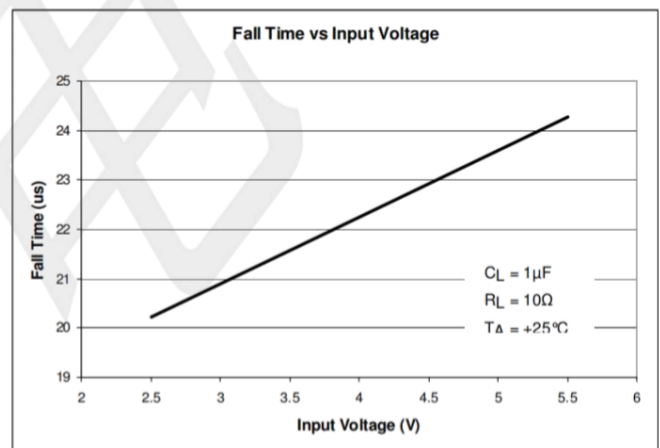
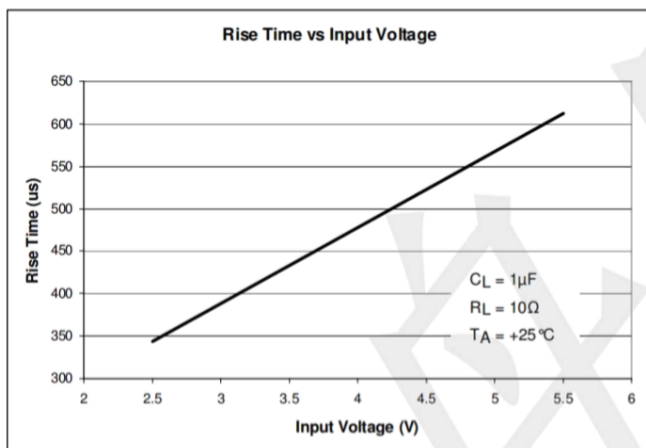
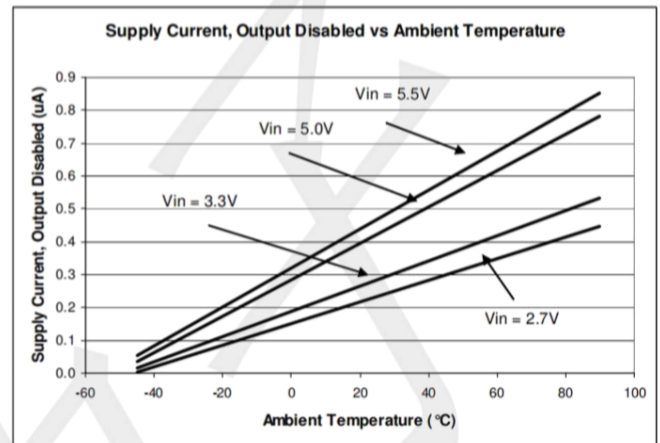
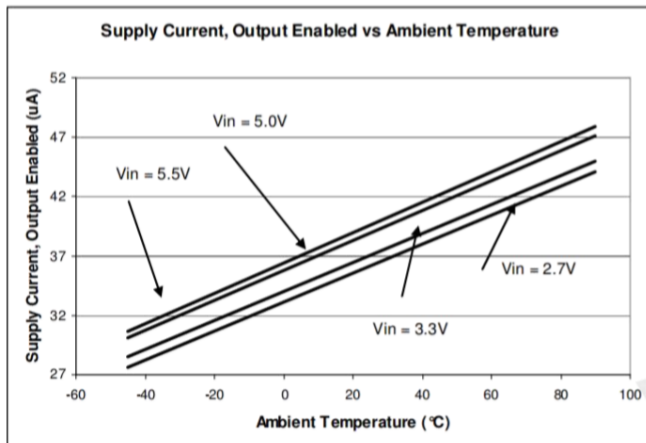

# TPUxx12S5&TPUxx13S5 Series Low Loss Power Switch With Flag

[WWW.TECHPUBLIC.COM](http://WWW.TECHPUBLIC.COM)

## Package information (unit: mm)

SOT23-5L

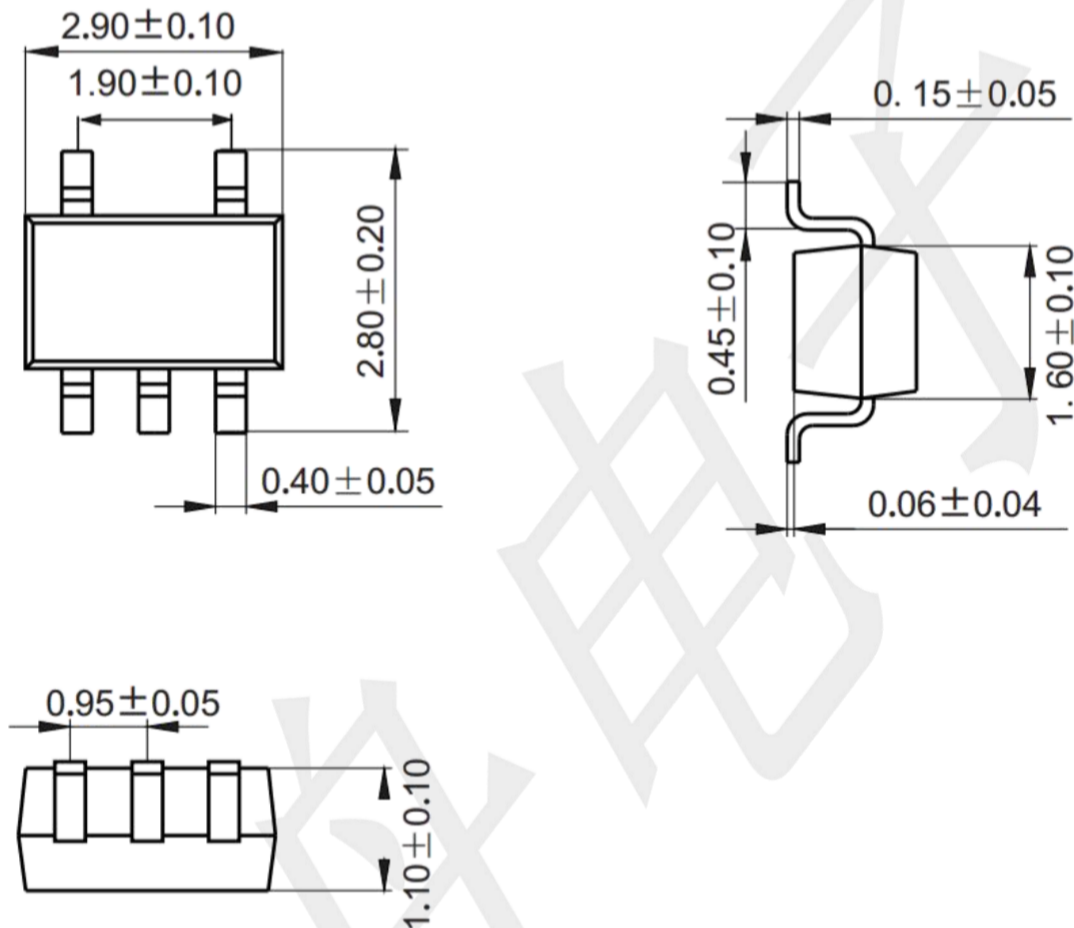

## Mounting Pad Layout (unit: mm)

