

承 认 书
APPROVAL SHEET

客户名称 Customer Name	
客户料号 Customer PN	
产品名称 Product Name	插件式铝电解电容 Plug-in Aluminum Electrolytic Capacitor
型号规格 Specification	KS 82uF400V 18X25
厂商料号 Vendor PN	KS400V82M18X25
发行日期 Issue Date	2026/3/18

发行单位 ISSUED EPARTMENT	
	
制作 PREPARED BY	贺金欢 HE JIN HUAN
批准 APPROVED	李伟业 LI WEI YE

客户承认 APPROVED COLUMN	
<input type="checkbox"/> 合格 <input type="checkbox"/> 不合格	
审核 CHECKED	
批准 APPROVED	

贵司确认后，敬请回签一份 (After your confirmation, please sign back)

1.外形尺寸图 (Dimensions)

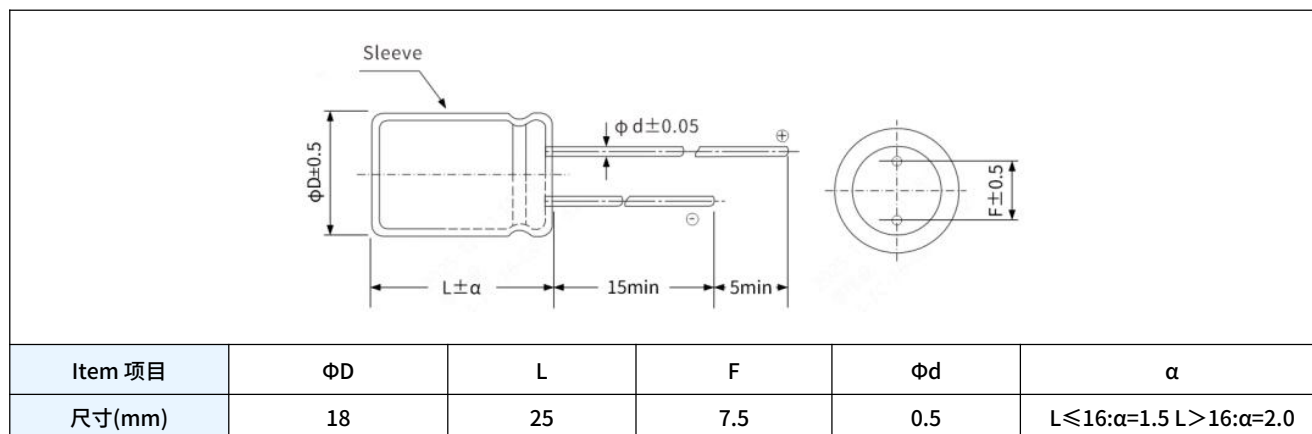

2.规格特性表 Specification and Specifications Table

料号 Part Number	参数 Parameter	单位 unit	条件 condition
系列 Series	KS	-	-
标称容量 Cap.	82	μF	-
额定电压 R.V.	400	V	-
尺寸 Size DXL	18×25	mm	-
容差 Tolerance	- 20~+20	%	-
损失角 DF (max)	15	%	120Hz
漏电流 LC(max)	984	μA	120S
阻抗 ESR(max)	1.5	Ω	100KHz
纹波电流 R.C.(max)	410	mA	100KHz/105°C
浪涌电压 S.V.	450	V	-
寿命 Life	3000	hrs	105°C
套管颜色和材质 Sleeve	黑底白字 PET	-	-
工作温度 Temp.	-40~105	°C	-

执行标准(Execution standard) :SJ/T11000-2023

测试环境(In the test environment) :温度 T 20±2°C , 湿度 RH 65%±5%

3. 纹波电流修正系数(Multiplier for Ripple Current)

3.1 频率系数 Frequency Multipliers

Freq. Cap.	60Hz	120Hz	1KHz	10KHz	100KHz~
Under 10uF	0.47	0.59	0.85	0.97	1.00
10<C≤100	0.52	0.65	0.89	0.97	1.00
100<C≤1000	0.58	0.72	0.90	0.98	1.00
1,000 up above	0.63	0.78	0.91	0.98	1.00

3.2 温度系数 Temperature Multipliers

Temperature(°C)	45	60	70	85	105
Multiplier	2.10	1.90	1.65	1.40	1.00

4. 套管标识示意图 Marking

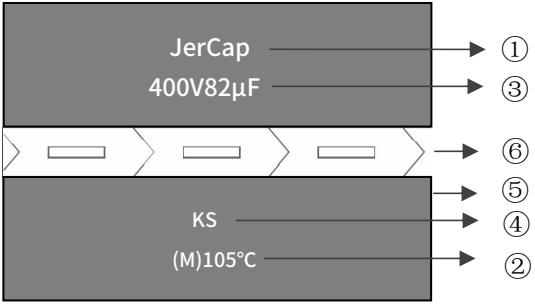
	1.公司商标(Logo)
	2.工作最高温度与容量范围 (Operating Temperature Range and Capacitance Tolerance)
	3.电容器规格(额定电压和容量) Capacitance and Rated Voltage
	4.产品系列(Series)
	5.胶管材质(Material PET)
	6.负极表示带 (Polarity bar)
	7.颜色印字 Sleeve Color :黑底白字

5. 材料表 Material Table

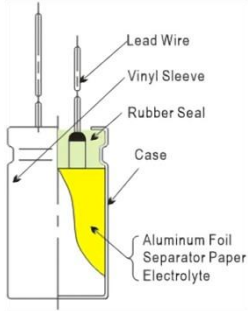
		
序号 NO	构成部件 Component	材质成分 Material
1	铝箔 Aluminum Foil	铝 Aluminum
2	电解纸 Separator Paper	木浆 Wood Pulp
3	电解液 Electrolyte	乙二醇/己二酸铵 Ethylene Glycol/Ammonium Adipate
4	铝壳 Case	铝 Aluminum
5	密封塞 Sealing Plug	橡胶 Rubber
6	引线 Lead Wire	镀锡铜包钢线 TPCSW
7	胶管 Sleeve	PET

注:电容产品和构成材料均满足 ROHS2.0、REACH、HF 禁用环境管理物质要求。

Note: The capacitor products and their constituent materials meet the requirements for ROHS2.0, REACH, and HF banned environmental management substances.

6.测试与试验项目 Test Item

No.	项目 Items	条件 Conditions	判定 Decide												
1	静电容量 Capacitance	测试频率: 120Hz Test Frequency:120Hz 测试电压: ≤ 0.5Vrms	静电容量允许偏差: ≤参考规格参数 Capacitance tolerance: ≤Refer to the SPEC TABLE												
2	损耗角正切值 Dissipation Factor	Test Voltage: ≤ 0.5Vrms 测试温度: 20±2°C Test Temperature: 20±2°C	参考规格参数 Refer to the SPEC TABLE												
3	漏电流 Leakage Current	测试电压: 额定电压 Test Voltage: Rated voltage 充电时间: 2分钟 Charging: 2min 测试温度: 20±2°C Test Temperature: 20±2°C	I ≤ 0.01CV 或 3μA (以较大值为准) I ≤ 0.01CV or 3μA (whichever is greater)												
4	温度循环 Temperature Cycle	<table border="1"> <thead> <tr> <th></th> <th>温度 Temperature(°C)</th> <th>时间 Time (minutes)</th> </tr> </thead> <tbody> <tr> <td rowspan="4">周期 One Cycle</td> <td>Rated high category temperature ± 3</td> <td>30 ± 3</td> </tr> <tr> <td>25°C</td> <td>3max</td> </tr> <tr> <td>Rated low category temperature ± 3</td> <td>30 ± 3</td> </tr> <tr> <td>25°C</td> <td>3max</td> </tr> </tbody> </table> <p>循环次数 Total number of cycles: 5</p>		温度 Temperature(°C)	时间 Time (minutes)	周期 One Cycle	Rated high category temperature ± 3	30 ± 3	25°C	3max	Rated low category temperature ± 3	30 ± 3	25°C	3max	1.外观无损坏 No appearance defect 2.容量变化率在±5%以内 Capacitance change within ±5% 3.损耗角正切: ≤初始规定值 Dissipation factor: ≤ Initial specified value 4.漏电流: ≤初始规定值 Leakage current: ≤ Initial specified value
	温度 Temperature(°C)	时间 Time (minutes)													
周期 One Cycle	Rated high category temperature ± 3	30 ± 3													
	25°C	3max													
	Rated low category temperature ± 3	30 ± 3													
	25°C	3max													
5	耐焊接热 Resistance to Soldering Heat	预热时间: 120±2秒, 达到 120±2°C Warm up time: 120±2 seconds, to reach 120±2°C 焊锡炉温度: 260±5°C . Solder bath temperature: 260±5°C . 焊料成分: Solder bath composition: Sn-96.5% , Ag-3.0% , Cu-0.5% 浸入深度: 1.5~2.0mm Immersion depth: 1.5 to 2.0mm 浸入时间: 10±1秒 Immersion duration: 10±1 seconds	1.无外观缺陷 No appearance defect 2.容量变化在±5%以内 Capacitance change within ±5% 3.损耗角正切: ≤初始规定值 Dissipation factor: ≤ Initial specified value 4.漏电流: ≤初始规定值 Leakage current: ≤ Initial specified value												
6	可焊性 Solder Ability	焊锡炉温度: 235±5°C . Solder bath temperature: 235±5°C . 焊料成分: Solder bath composition: Sn-96.5% , Ag-3.0% , Cu-0.5% 浸入深度: 1.5~2.0mm Immersion depth: 1.5 to 2.0mm 浸入时间: 10±1秒 Immersion duration: 10±1 seconds	锡液要覆盖导针浸入表面积的 95%以上 A minimum of 95% the immersed surface is to be coated with the new solder.												

6.测试与试验项目 Test Item

No.	项目 Items	条件 Conditions	判定 Decide																																															
7	温度特性 Temperature Characteristics	<table border="1"> <thead> <tr> <th>阶段 Stage</th> <th>测试温度 Test temp</th> <th>时间 Time</th> </tr> </thead> <tbody> <tr> <td>1</td> <td>25±5</td> <td rowspan="5">时间达到热稳定时 When thermal stability is achieved</td> </tr> <tr> <td>2</td> <td>-25±3</td> </tr> <tr> <td>3</td> <td>-40±3</td> </tr> <tr> <td>4</td> <td>25±5</td> </tr> <tr> <td>5</td> <td>+105±3</td> </tr> </tbody> </table>	阶段 Stage	测试温度 Test temp	时间 Time	1	25±5	时间达到热稳定时 When thermal stability is achieved	2	-25±3	3	-40±3	4	25±5	5	+105±3	<table border="1"> <thead> <tr> <th>额定工作电压Voltage</th> <th>6.3</th> <th>10</th> <th>16</th> <th>25</th> <th>35-50</th> <th>63-100</th> </tr> </thead> <tbody> <tr> <td>Z(-25°C)/Z(20°C)</td> <td>8</td> <td>6</td> <td>4</td> <td>4</td> <td>3</td> <td>3</td> </tr> <tr> <td>Z(-40°C)/Z(20°C)</td> <td>18</td> <td>16</td> <td>12</td> <td>10</td> <td>8</td> <td>6</td> </tr> </tbody> </table> <table border="1"> <thead> <tr> <th>额定工作电压Voltage</th> <th>160~250</th> <th>350~450</th> <th>450~550</th> </tr> </thead> <tbody> <tr> <td>Z(-25°C)/Z(20°C)</td> <td>4</td> <td>8</td> <td>15</td> </tr> <tr> <td>Z(-40°C)/Z(20°C)</td> <td>8</td> <td>18</td> <td>---</td> </tr> </tbody> </table> <p>阻抗比: 阶段 2、3 与阶段 1 的阻抗比不超过上表值 Impedance Ratio: The impedance ratio between Stages 2, 3 and Stage 1 shall not exceed the values in the above table 容量变化率: 相对于阶段 1 值, 不超过±25% Capacitance Change: Relative to the value in Stage 1, it shall not exceed ±25% 损耗角正切值: 不超过 5 倍规格值 DF: Shall not exceed 5 times the specified value 泄漏电流: 不超过规格值 LC ≤ Initial specified value</p>	额定工作电压Voltage	6.3	10	16	25	35-50	63-100	Z(-25°C)/Z(20°C)	8	6	4	4	3	3	Z(-40°C)/Z(20°C)	18	16	12	10	8	6	额定工作电压Voltage	160~250	350~450	450~550	Z(-25°C)/Z(20°C)	4	8	15	Z(-40°C)/Z(20°C)	8	18	---
阶段 Stage	测试温度 Test temp	时间 Time																																																
1	25±5	时间达到热稳定时 When thermal stability is achieved																																																
2	-25±3																																																	
3	-40±3																																																	
4	25±5																																																	
5	+105±3																																																	
额定工作电压Voltage	6.3	10	16	25	35-50	63-100																																												
Z(-25°C)/Z(20°C)	8	6	4	4	3	3																																												
Z(-40°C)/Z(20°C)	18	16	12	10	8	6																																												
额定工作电压Voltage	160~250	350~450	450~550																																															
Z(-25°C)/Z(20°C)	4	8	15																																															
Z(-40°C)/Z(20°C)	8	18	---																																															
8	防爆 Vent	<p>施加反向直流电压 Apply reverse DC voltage:</p> <table border="1"> <thead> <tr> <th>电容直径 Capacitor diameter</th> <th>电流 Current(A)</th> <th>时间 Time</th> </tr> </thead> <tbody> <tr> <td>Less than 22.4mm</td> <td>1</td> <td rowspan="2">within 30</td> </tr> <tr> <td>More than 22.5mm</td> <td>10</td> </tr> </tbody> </table>	电容直径 Capacitor diameter	电流 Current(A)	时间 Time	Less than 22.4mm	1	within 30	More than 22.5mm	10	<p>在测试期间或之后, 电容器不应发生爆炸、闪光、火焰、火花或火灾, 也不应从外壳中喷出任何金属 There shall be no explosion, flash, flame, spark or fire from the capacitor during or after the test, nor shall there be expulsion of any metal from the casing</p>																																							
电容直径 Capacitor diameter	电流 Current(A)	时间 Time																																																
Less than 22.4mm	1	within 30																																																
More than 22.5mm	10																																																	
9	振动 Vibration	<p>频率范围: 10 Hz 至 55 Hz Frequency range : 10 Hz to 55 Hz 振幅: 1.5 毫米 Amplitude :1.5 mm 总持续时间: 3×2h. X-Y-Z 方向各 2 小时 Total duration: 3×2h. x-y-z directions each for 2 hours</p>	<p>1.外观:无明显的损伤或电解液漏出 Appearance: No visible damage or leakage of electrolyte 2.电容量变化: 初始值的±5%以内 Capacitance change: within ±5% of the initial value</p>																																															
10	高温负荷 Load Life	<p>电容依照额定寿命在上限温度下施加额定电压及纹波电流, 待其恢复室温后进行测量 In accordance with its rated life conditions, apply the rated voltage and ripple current to the capacitor under the upper limit temperature. Conduct the measurement after the capacitor returns to room temperature.</p>	<p>1.外观:无明显的损伤或电解液漏出 Appearance: No visible damage or leakage of electrolyte 2.电容量变化:初始值的±20%以内 Capacitance change: within ±20% of the initial value 3.损耗角正切: ≤200%规定值 Dissipation factor: ≤200% of specified value 4.漏电流: ≤规定值 Leakage Current: ≤Specified value</p>																																															
11	高温储存 Shelf Life	<p>温度: 上限温度 Temperature: Upper limit temperature 时间 Time: 1000h</p>	<p>1.外观:无明显的损伤或电解液漏出 Appearance: No visible damage or leakage of electrolyte. 2.电容量变化:初始值的±20%以内 Capacitance change: within ±20% of the initial value. 3.损耗角正切: ≤200%规定值 Dissipation factor: ≤200% of specified value 4.漏电流: ≤200%规定值 Leakage Current: ≤200% of specified value</p>																																															

6. 测试与试验项目 Test Item

No.	项目 Items	条件 Conditions	判定 Decide								
12	浪涌电压 Surge Voltage	试验温度: 105±2°C Test Temp: 105±2°C 试验电压: 浪涌电压 Test voltage: surge voltage 施加浪涌电压 30 秒, 然后放电 330 秒, 共循环 1000 次 Charge surge voltage for 30 seconds and discharge for 330 seconds. Repeat this cycle 1000 times.	1. 电容量变化: 初始值的 ±15% 以内 Capacitance change: within ±15% of the initial value 2. 损耗角正切: ≤ 规定值 Dissipation factor: ≤ Specified value 3. 漏电流: ≤ 规定值 Leakage current: ≤ Specified value 4. 外观: 无可见损伤 Appearance: No visible damage								
		UR (V)		10	16	25	35	50	63	80	100
		S.V(V)		13	20	32	44	63	79	100	125
		UR (V)		160	200	250	350	400	450	500	550
		S.V(V)		200	250	300	400	450	500	550	600

7. 铝电解电容使用注意事项 Precautions for Using Aluminum Electrolytic Capacitors

1. 铝电解电容是有极性的, 请按正确的极性使用。当反向接入线路时, 会导致回路短路或电容损坏。当回路的有可能反向或极性不明时, 请使用无极性电容。

Aluminum electrolytic capacitors are polarized and shall be used with the correct polarity. Reverse connection in the circuit will result in short circuit or capacitor damage. If there is a possibility of reverse polarity or unclear polarity in the circuit, non-polarized capacitors shall be used.

2. 不要施加反向电压或超过额定电压的直流电压, 当施加电压超过额定电压时, 漏电流会显著增加导致电容损坏。推荐在额定电压下使用以保证寿命。浪涌电压是电容能短时间承受的最高电压。

Do not apply reverse voltage or DC voltage exceeding the rated voltage. When the applied voltage exceeds the rated voltage, the leakage current will increase significantly, leading to capacitor damage. It is recommended to use the capacitor at the rated voltage to ensure service life. Surge voltage refers to the maximum voltage that the capacitor can withstand for a short period.

3. 纹波电流应小于额定值。施加纹波电流超过额定值后, 会导致电容器本体过热, 容量下降, 寿命缩短。所施加纹波电压的峰值与直流电压之和应小于额定工作电压。

The ripple current shall be less than the rated value. Applying a ripple current exceeding the rated value will cause the capacitor body to overheat, resulting in reduced capacitance and shortened service life. The sum of the peak value of the applied ripple voltage and the DC voltage shall be less than the rated working voltage.

4. 请在额定温度范围内使用电容器。如果在上限温度以上使用电容器将会导致使用寿命大大缩短或防爆阀开启, 在室温下使用会保证更长的使用寿命。科学统计, 使用环境温度每下降 10 摄氏度其使用寿命增加一倍。

Please use the capacitor within the rated temperature range. Using the capacitor above the upper limit temperature will significantly shorten its service life or trigger the explosion-proof valve. Use at room temperature will ensure a longer service life. Scientific statistics show that the service life doubles for every 10°C decrease in the operating environment temperature.

5. 当电容器长期贮存后, 其漏电流会升高, 贮存温度越高, 漏电流上升越快。因此应注意贮存环境, 在电容器上施加电压后, 漏电流将不断下降, 如果漏电流值上升对电路有不良影响, 请在使用前充电处理。

After the capacitor is stored for a long time, its leakage current will increase, and the higher the storage temperature, the faster the leakage current rises. Therefore, attention should be paid to the storage environment. When a voltage is applied to the

capacitor, the leakage value will continuously decrease. If the increase in leakage current exerts adverse effects on the circuit, charging treatment should be performed before use.

6. 电容不适合用在频繁充放电的电路。容量会由于负极氧化膜的氧化而容量减小，或电容通过充放电产生的热量而损坏。

Capacitors are not suitable for circuits with frequent charging and discharging. The capacitance will decrease due to the oxidation of the negative electrode oxide film, or the capacitor may be damaged by the heat generated during charging and discharging.

7. 不良的安装或者对引线施加应力会使产品内部结构损坏，导致漏电流高或者漏液问题。

Poor installation or applying stress to the leads may damage the internal structure of the product, resulting in high leakage current or electrolyte leakage.



a). 焊接良好 Good soldering

b). PCB 孔与孔之间的间距与引线间距不同 The pitch between PCB holes does not match the lead pitch.

c). 不要弯曲引线 Do not bend the leads.

d). 当焊接不平时，不要弯曲或扭曲电容本体 Do not bend or twist the capacitor body if the soldering is uneven.

8. 在进行浸锡或焊接时，其胶管可能因焊接时间过长、温度过高为发生破裂或者二次收缩。

During tin dipping or soldering, the hose may crack or shrink secondary due to excessive soldering time or excessively high temperature.

9. 铝电解电容器不能使用卤化有机物系列的清洗剂进行清洗。如果必须清洗，请使用能够保证电容器质量的清洗剂。对于能够保证清洗质量的清洗剂，清洗后请不要在清洗溶液或者密封容器中保管。清洗后的电容器和电路板一起在热风下干燥 10 分钟以上，热风的温度不可高于电容器的上限温度。

Aluminum electrolytic capacitors shall not be cleaned with halogenated organic compound-based cleaning agents. If cleaning is necessary, use a cleaning agent that can ensure the capacitor quality. For cleaning agents that meet the cleaning quality requirements, do not store the cleaned capacitors in the cleaning solution or sealed containers after cleaning. Dry the cleaned capacitors together with the circuit board under hot air for more than 10 minutes, and the temperature of the hot air shall not exceed the upper limit temperature of the capacitor.

请不要使用含有卤化有机物系列的固定剂及涂层剂。更不要让固定剂或涂层剂将电容器封口部位全部封住。

Do not use fixatives or coating agents containing halogenated organic compounds. Furthermore, do not allow the fixative or coating agent to completely seal the capacitor's sealing area.

推荐储存在 5~35°C，相对湿度小于 75%RH 无阳光直射的环境。产品出厂储存期限为 12 个月。如果储存时间超过 12 个月，请检查电气特性及可焊性。

It is recommended to store the product in an environment with a temperature of 5~35°C, relative humidity (RH) <75%, and no direct sunlight. The shelf life of the product from the date of manufacture is 12 months. If the storage period exceeds 12 months, the electrical characteristics and solderability shall be inspected.

当电容器需要报废时，请联系当地的工业废弃物处理商。

When the capacitor needs to be discarded, please contact the local industrial waste disposal company.

8.符合 RoHS RoHS Compliance

符合欧盟 RoHS 的最新标准，若客户有特殊要求，按照双方签订的相关协议为准。

Completely in accordance with the latest standard of RoHS or relevant agreements reached by both parts if customer has special requirements.